

TEXTILE MACHINERY

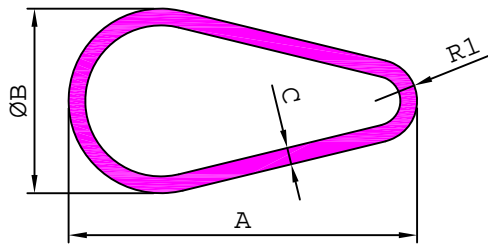

| SL. No. | Section No. | A | ØB | C | R1 | Weight kg/m |
|---------|-------------|-------|-------|------|------|-------------|
| 1 | 24701 | 38.25 | 27.94 | 1.27 | 8.41 | 0.343 |
| 2 | 24713 | 39.40 | 21.00 | 1.20 | 4.45 | 0.303 |

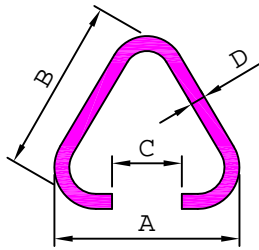

| SL. No. | Section No. | A | B | C | D | Weight kg/m |
|---------|-------------|-------|-------|------|------|-------------|
| 1 | 24757 | 21.80 | 24.30 | 7.00 | 0.80 | 0.133 |
| 2 | 24715 | 24.80 | 24.80 | 8.00 | 1.10 | 0.192 |

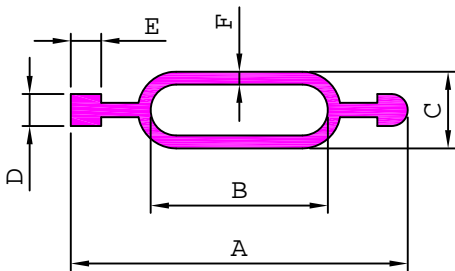

| SL. No. | Section No. | A | B | C | D | E | F | Weight kg/m |
|---------|-------------|-------|-------|-------|------|------|------|-------------|
| 1 | 24735 | 47.00 | 30.00 | 7.60 | 2.50 | 2.40 | 0.70 | 0.180 |
| 2 | 24732 | 60.00 | 41.00 | 8.40 | 3.50 | 2.65 | 0.85 | 0.287 |
| 3 | 24717 | 60.00 | 42.00 | 10.20 | 4.00 | 3.00 | 1.10 | 0.376 |

TEXTILE MACHINERY

17516 0.121 kg/m

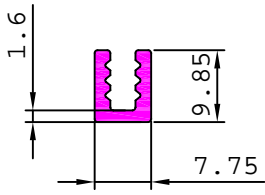

17525 0.084 kg/m

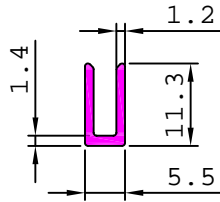

17526 0.080 kg/m

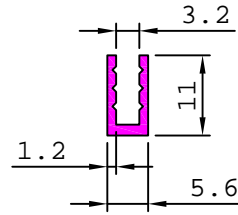

17567 0.124 kg/m

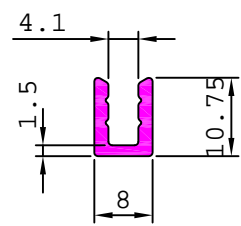

17568 0.194 kg/m

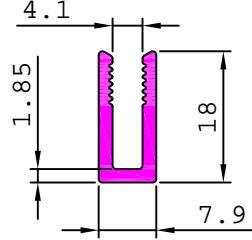

17577 0.140 kg/m

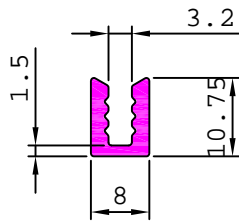

17620 0.133 kg/m

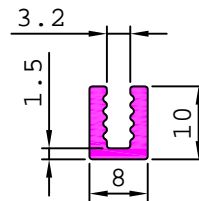

17623 0.107 kg/m

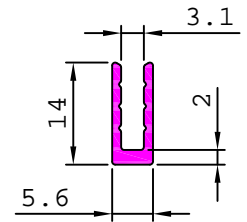

17639 0.120 kg/m

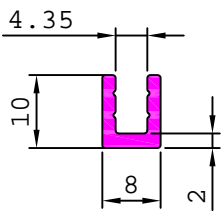

17674 0.306 kg/m

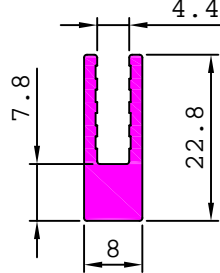

17687 0.223 kg/m

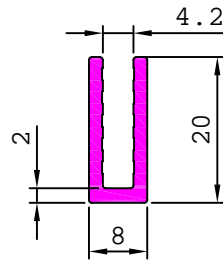

24836 0.219 kg/m

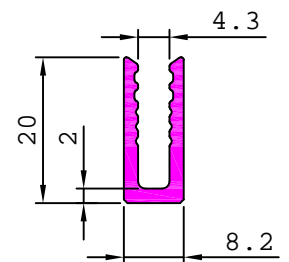

24817 0.108 kg/m

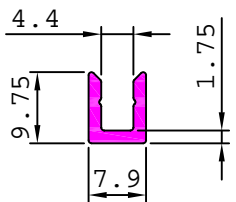

24818 0.186 kg/m

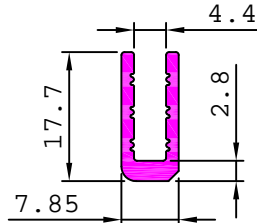

24826 0.144 kg/m

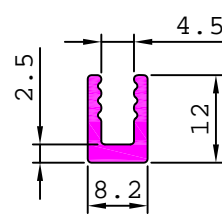

S4422 0.209 kg/m

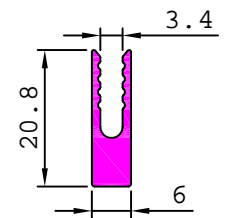

S4423 0.300 kg/m

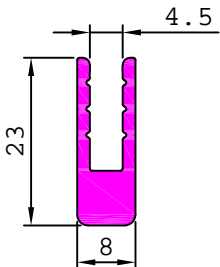

S4964 0.264 kg/m

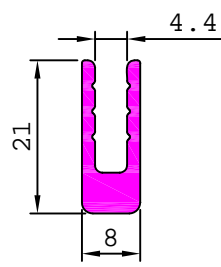

TEXTILE MACHINERY

24805

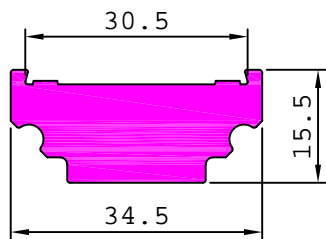

1.043 kg/m

24816

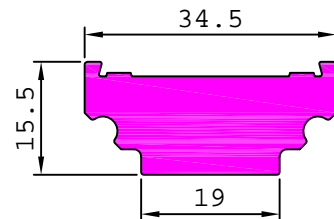

1.042 kg/m

24751

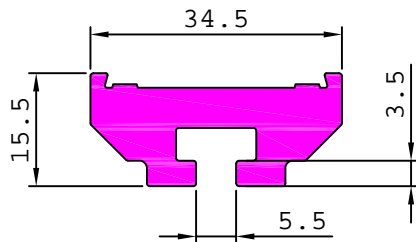

0.891 kg/m

24741

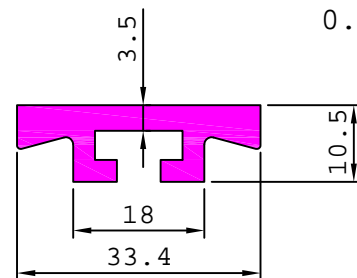

0.547 kg/m

24743

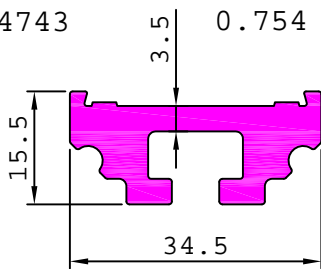

0.754 kg/m

24755

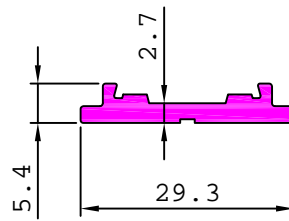

0.255 kg/m

24887

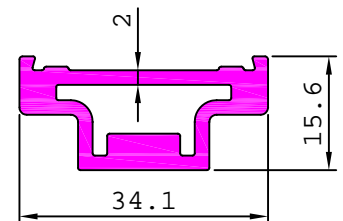

0.608 kg/m

24771

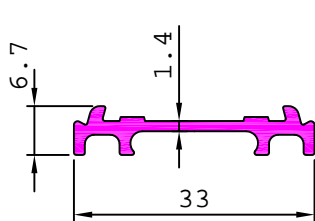

0.226 kg/m

24775

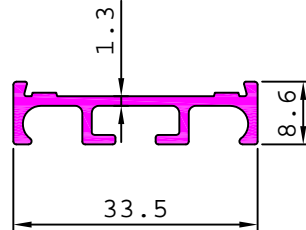

0.259 kg/m

24780

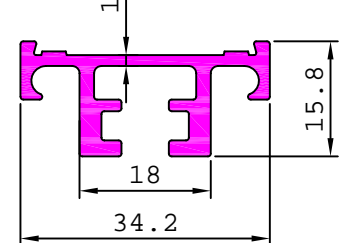

0.453 kg/m

24793

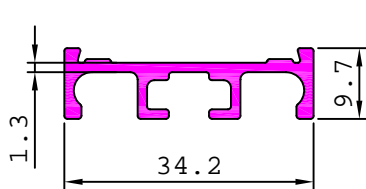

0.303 kg/m

24804

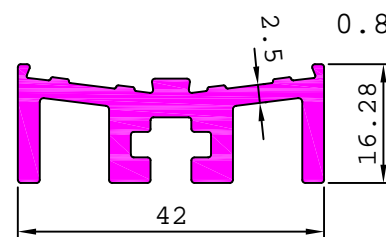

0.807 kg/m

24814

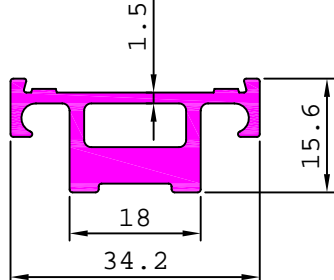

0.556 kg/m

24815

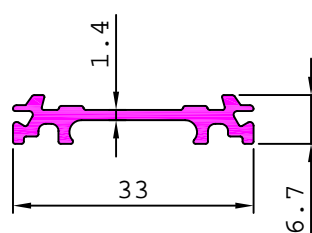

0.231 kg/m

24810

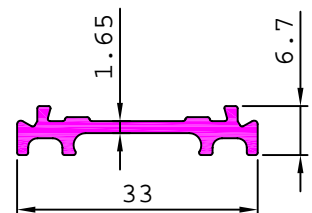

0.245 kg/m

TEXTILE MACHINERY

24821 0.326 kg/m

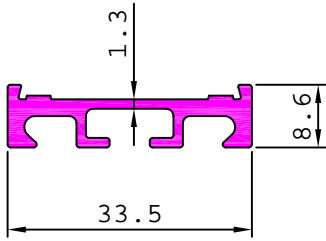

24822 0.394 kg/m

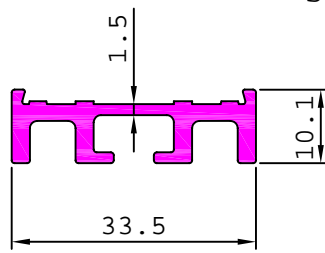

24827 0.379 kg/m

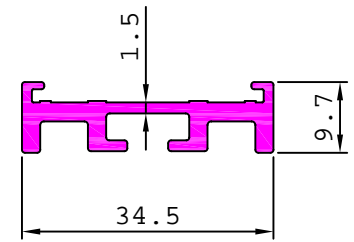

24813 0.825 kg/m

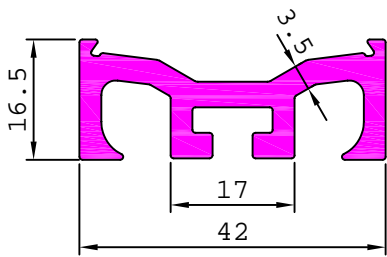

24882 0.380 kg/m

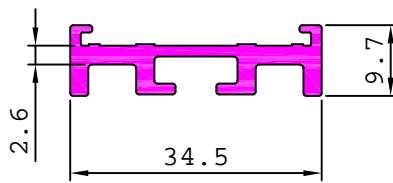

24863 0.502 kg/m

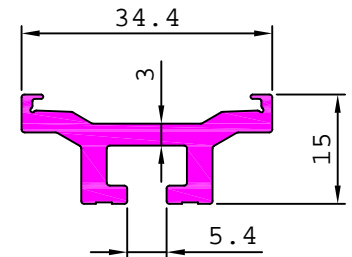

24854 0.426 kg/m

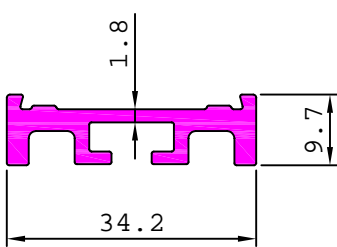

24877 0.613 kg/m

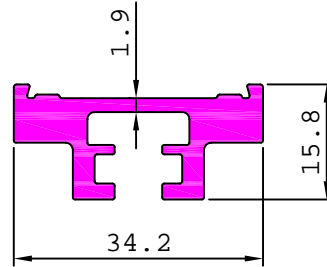

24853 0.610 kg/m

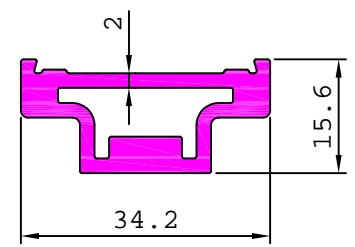

24868 0.252 kg/m

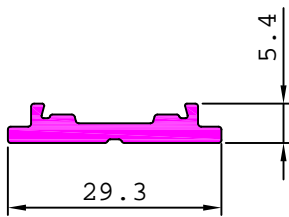

24837 0.152 kg/m

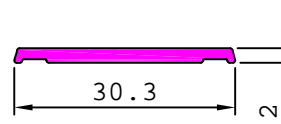

24838 0.119 kg/m

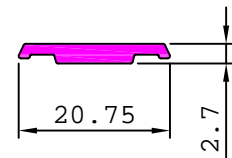

24839 0.124 kg/m

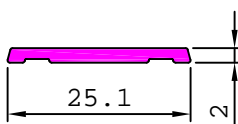

24842 0.085 kg/m

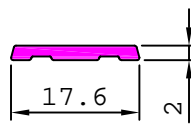

24847 0.250 kg/m

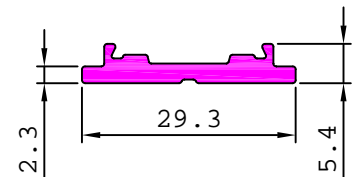

24855 0.713 kg/m

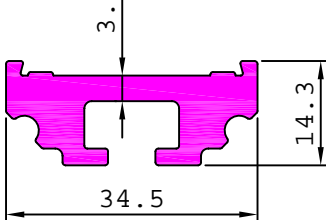

24856 0.848 kg/m

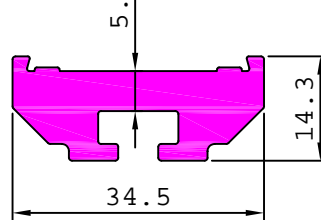

24883 0.991 kg/m

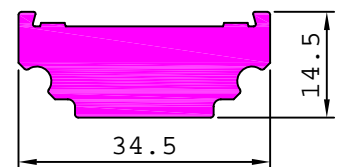

TEXTILE MACHINERY

S4561 0.151 kg/m

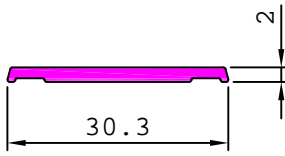

S4567 0.370 kg/m

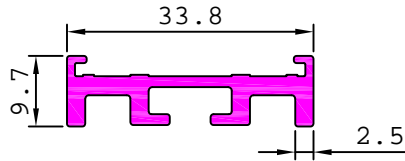

S4623 0.435 kg/m

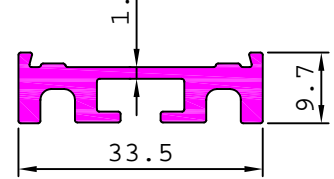

S4702 0.600 kg/m

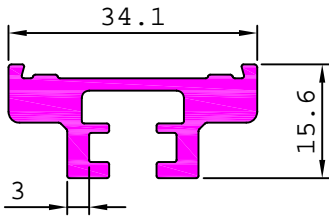

S4703 0.450 kg/m

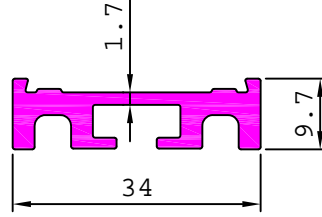

S4954 0.436 kg/m

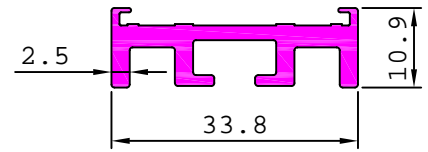

S5073 0.598 kg/m

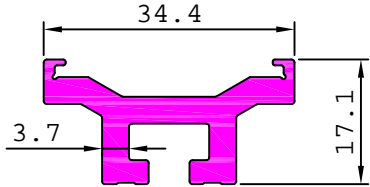

S5074 0.587 kg/m

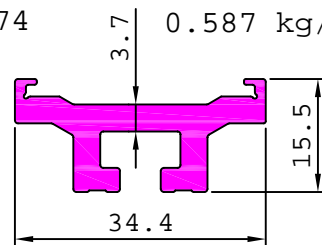

TEXTILE MACHINERY

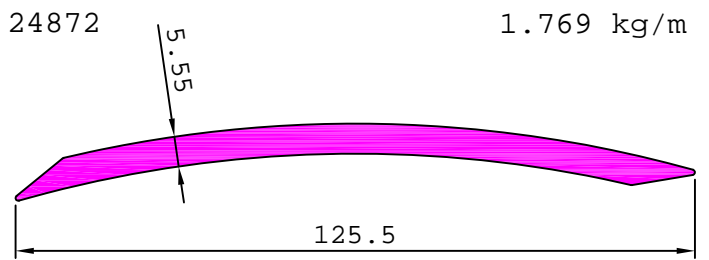
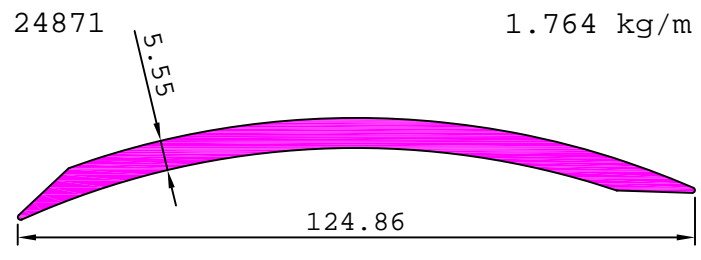
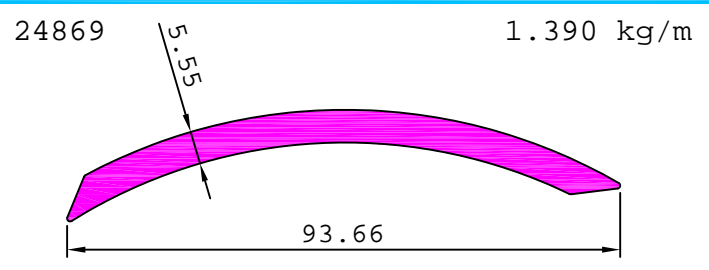
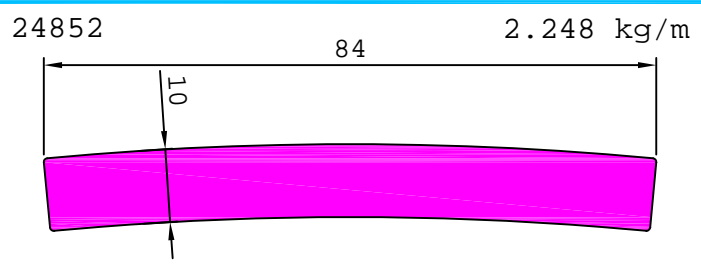
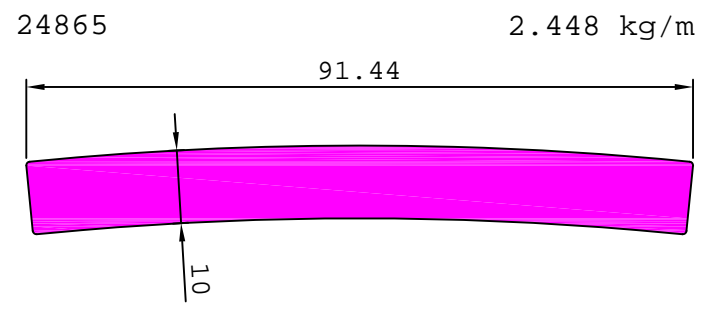
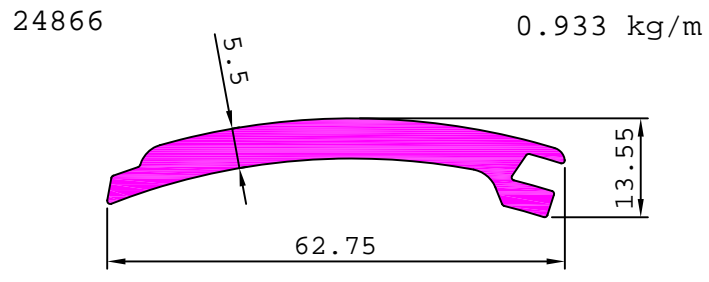
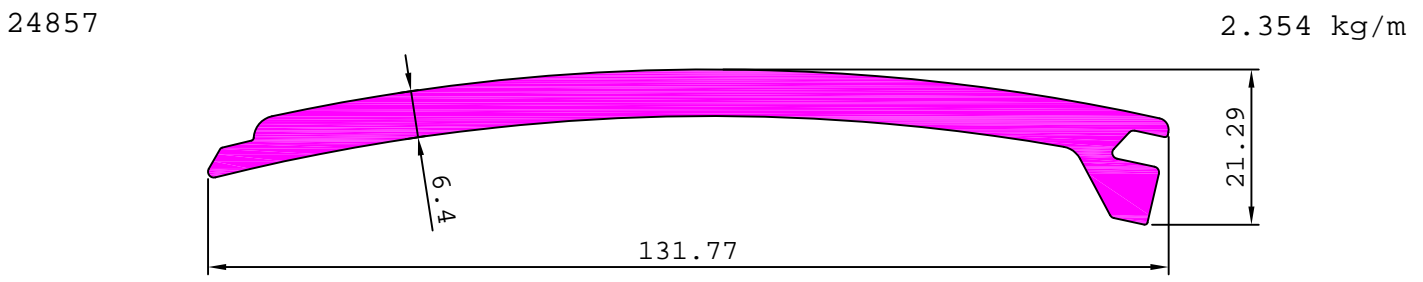
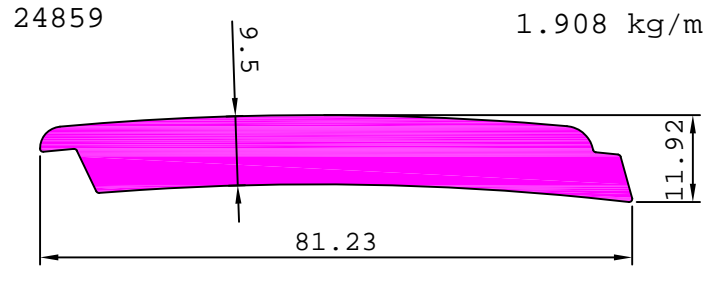
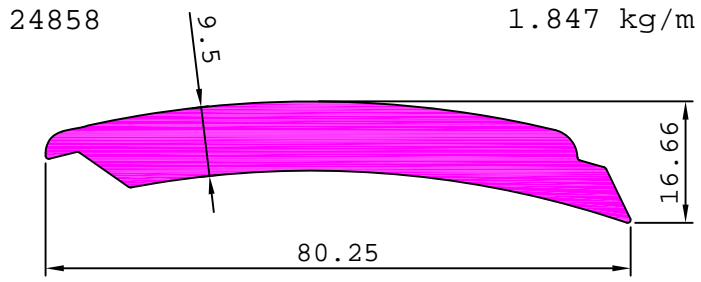
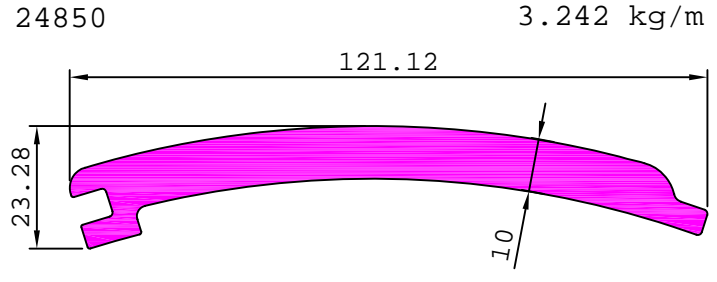
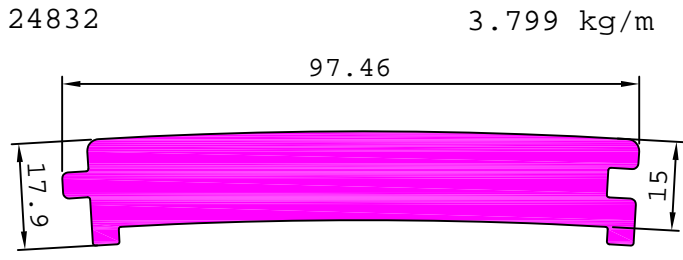

TEXTILE MACHINERY

24873 2.167 kg/m

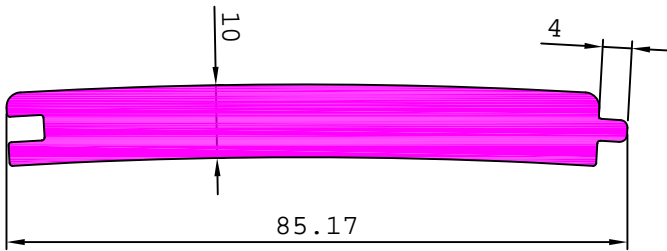

24875 2.382 kg/m

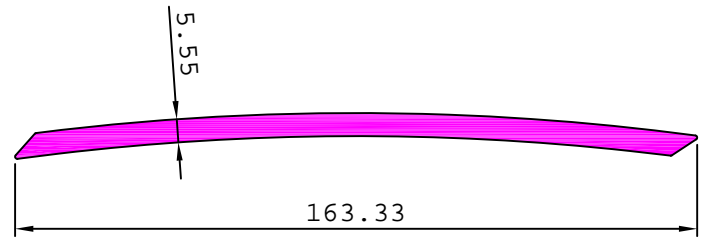

27989 2.204 kg/m

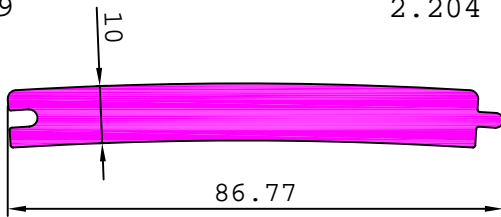

24849 2.290 kg/m

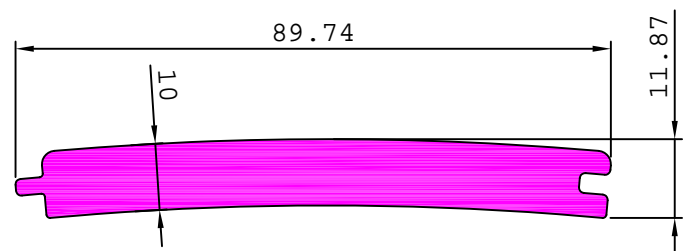

27975 3.317 kg/m

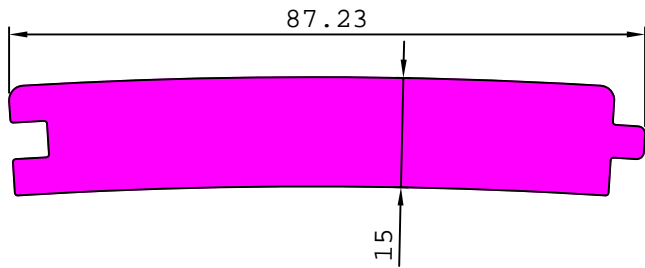

24886 3.390 kg/m

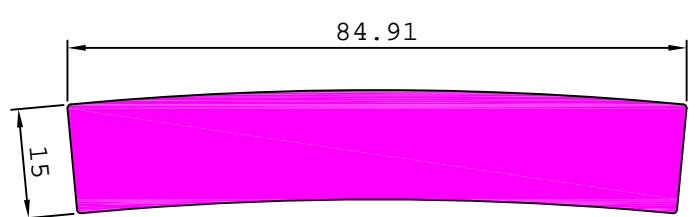

S4493 2.163 kg/m

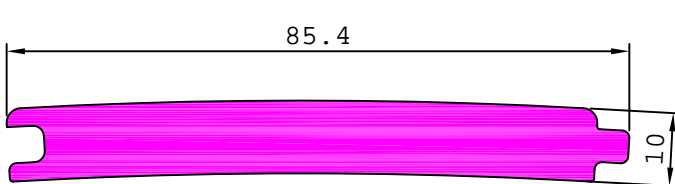

S4520 3.526 kg/m

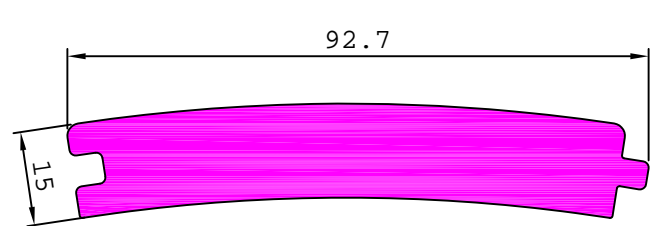

S4494 3.882 kg/m

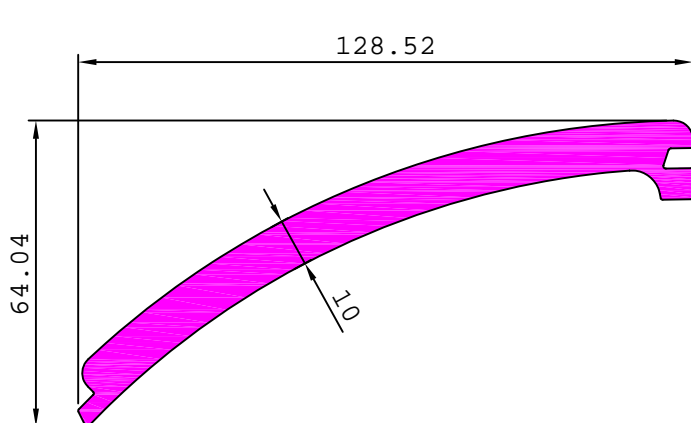

S4579 3.077 kg/m

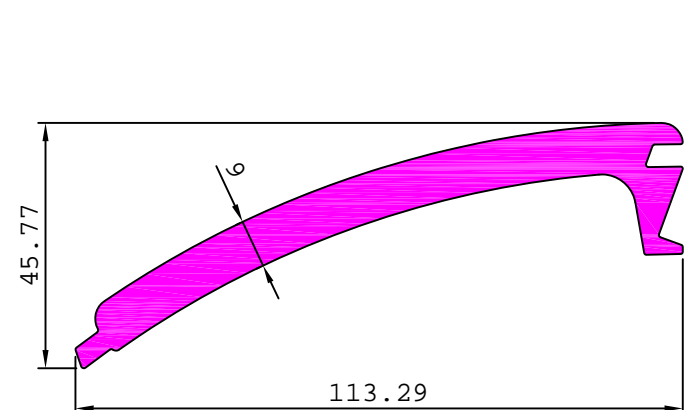

TEXTILE MACHINERY

S4784

2.207 kg/m

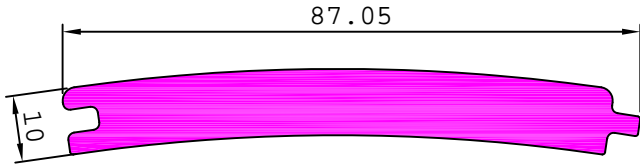

S4938

5.893 kg/m

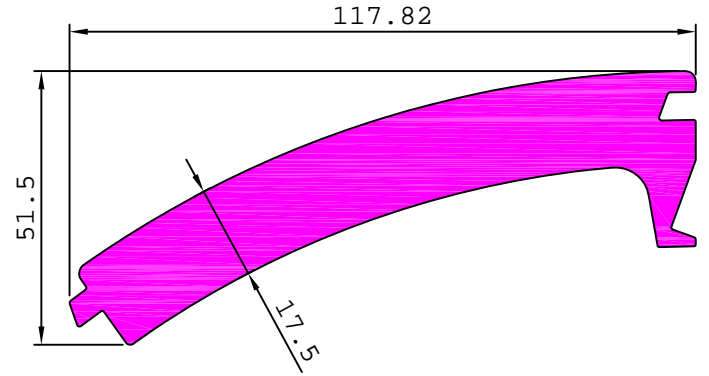

S4274

3.471 kg/m

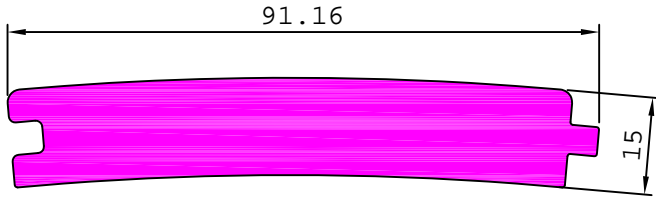

S4346

3.519 kg/m

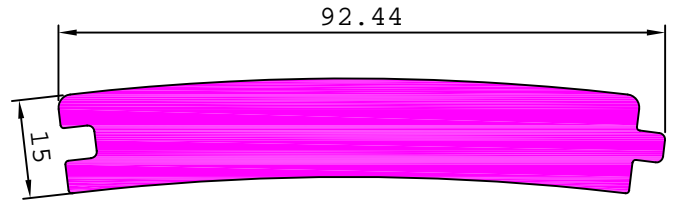

28109

2.314 kg/m

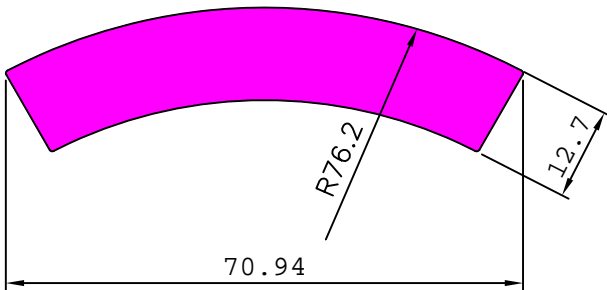

TEXTILE MACHINERY

24825 1.279 kg/m

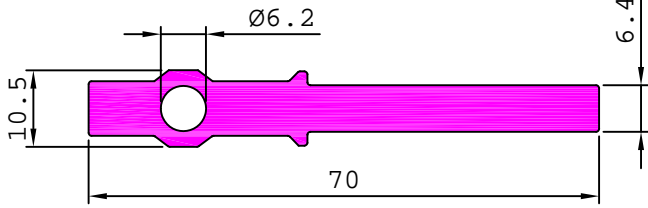

24806 1.594 kg/m

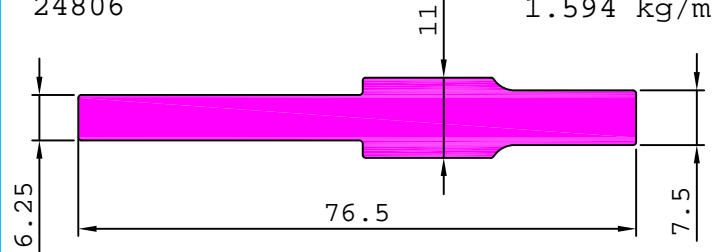

24811 1.786 kg/m

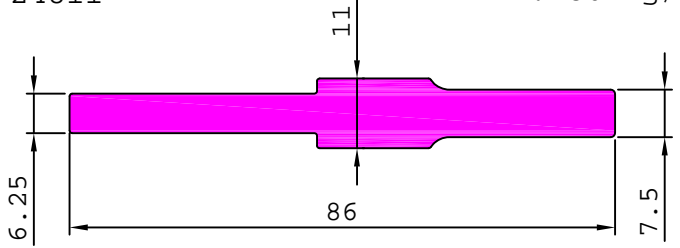

24840 1.172 kg/m

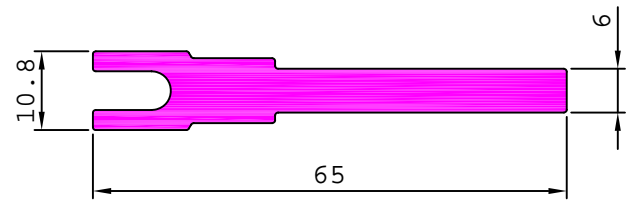

24841 1.427 kg/m

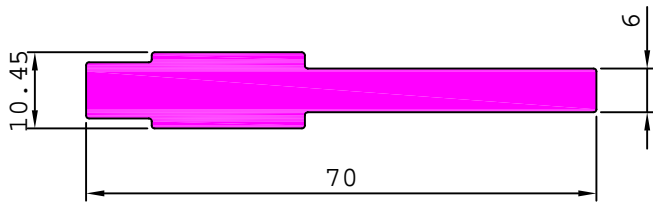

24846 1.129 kg/m

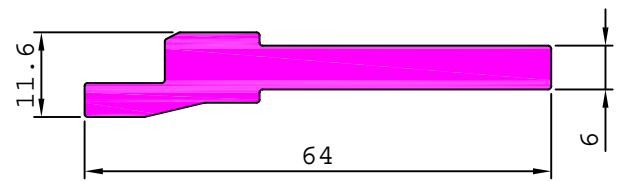

24876 1.046 kg/m

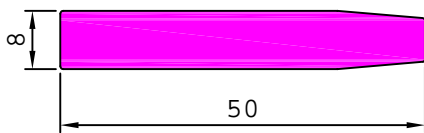

24861 0.897 kg/m

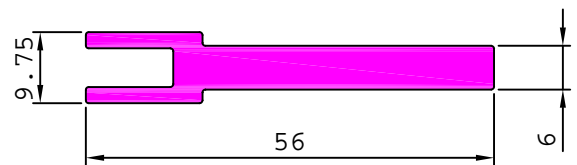

24862 0.939 kg/m

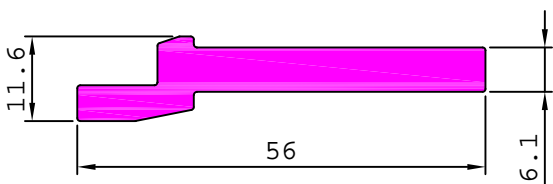

24880 1.626 kg/m

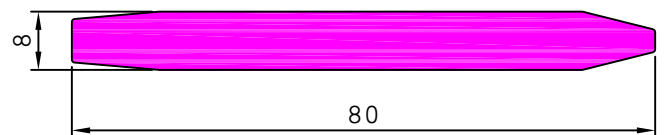

S4747 0.978 kg/m

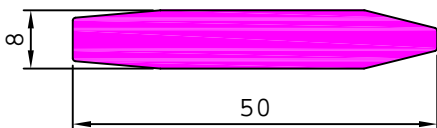

S4783 1.009 kg/m

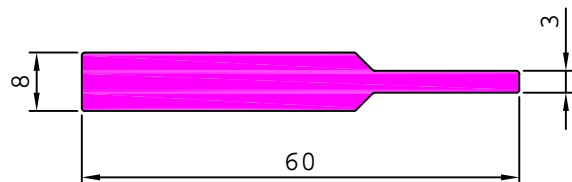

TEXTILE MACHINERY

24796

1.015 kg/m

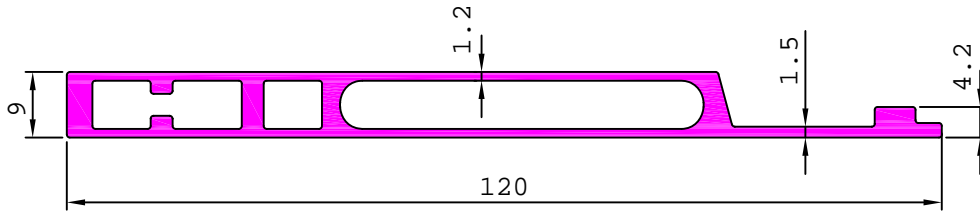

24797

0.981 kg/m

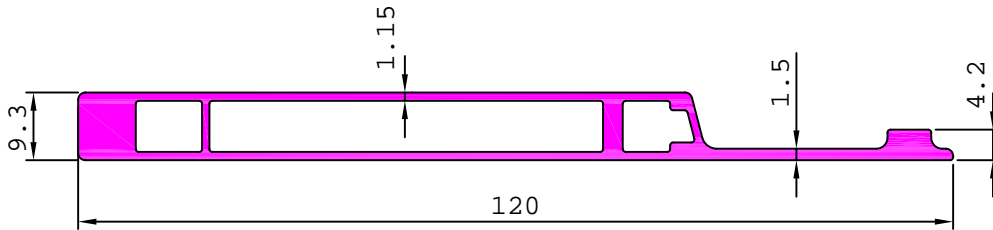

24802

0.908 kg/m

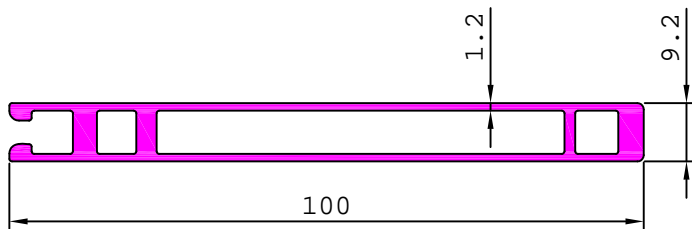

24848

0.855 kg/m

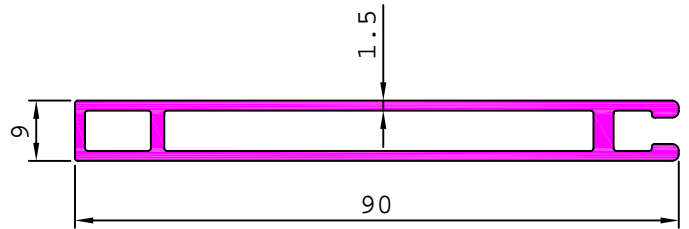

24807

1.217 kg/m

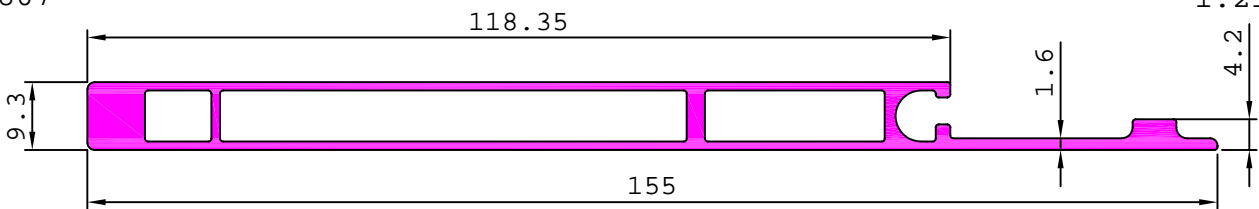

24808

1.017 kg/m

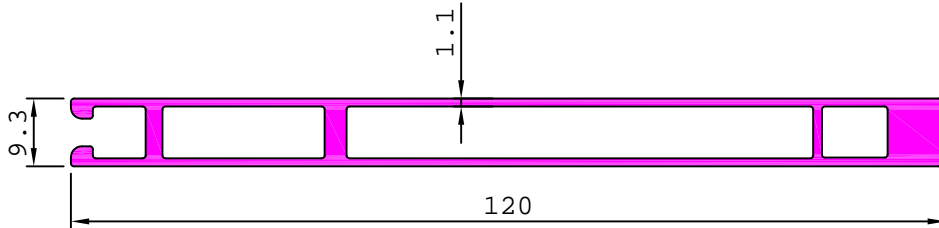

24812

1.038 kg/m

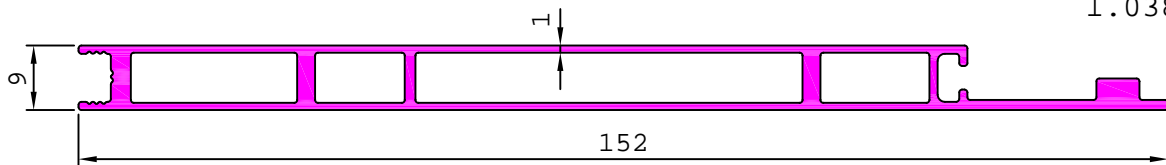

24819

1.252 kg/m

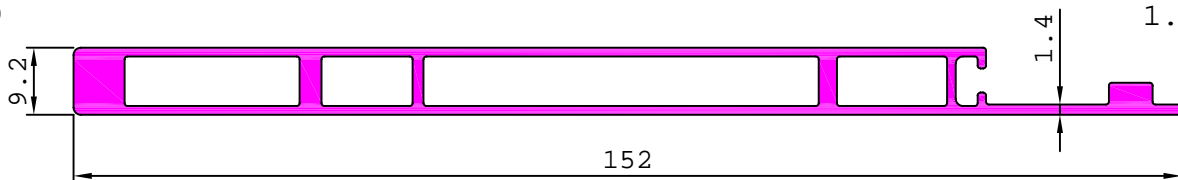

TEXTILE MACHINERY

24851

1.190 kg/m

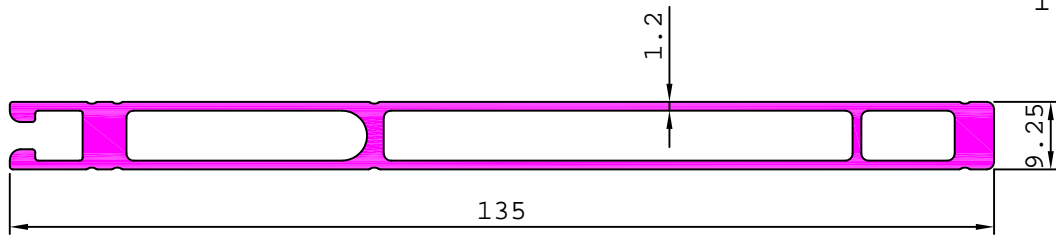

24831

0.838 kg/m

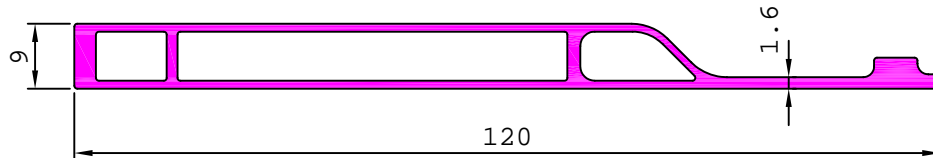

24878

0.949 kg/m

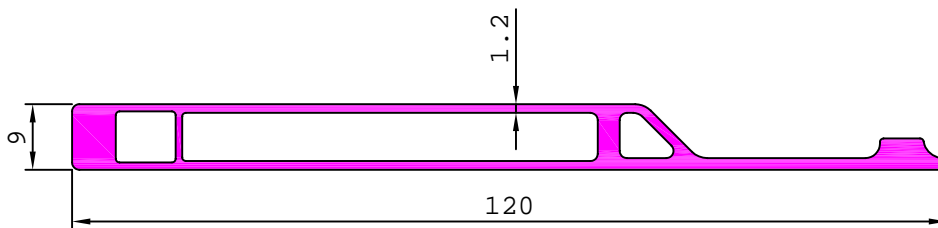

27622

0.946 kg/m

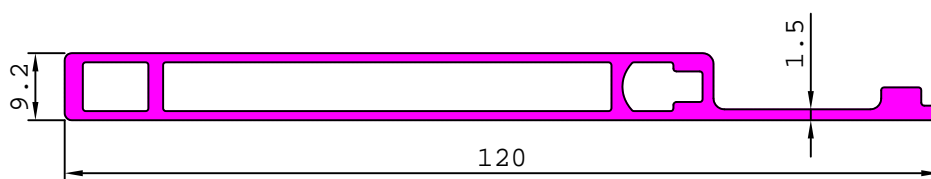

27359

0.830 kg/m

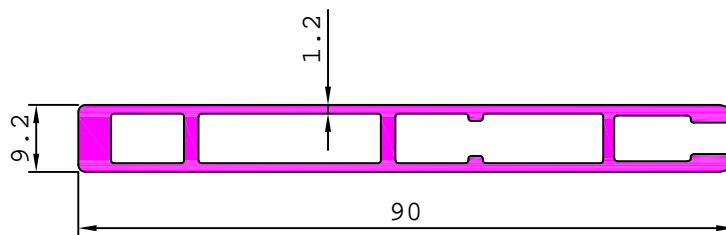

27665

0.780 kg/m

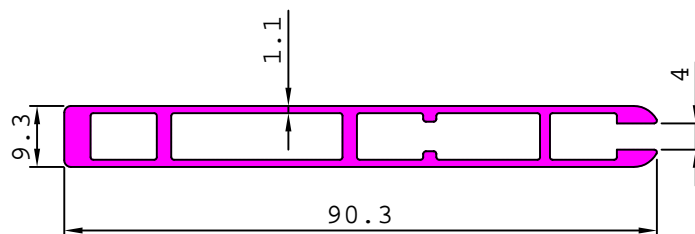

24864

1.067 kg/m

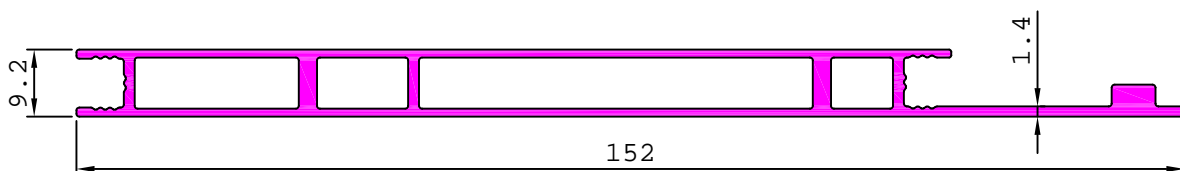

TEXTILE MACHINERY

S4400

0.862 kg/m

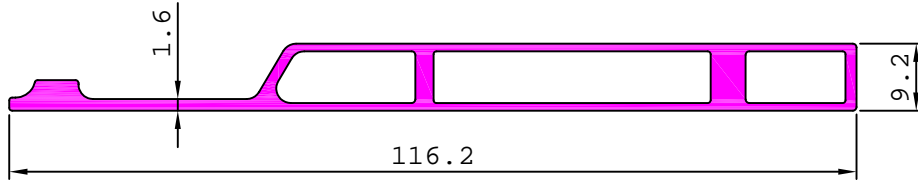

S4480

0.811 kg/m

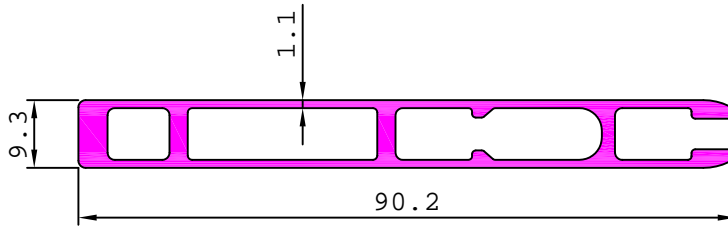

24890

1.101 kg/m

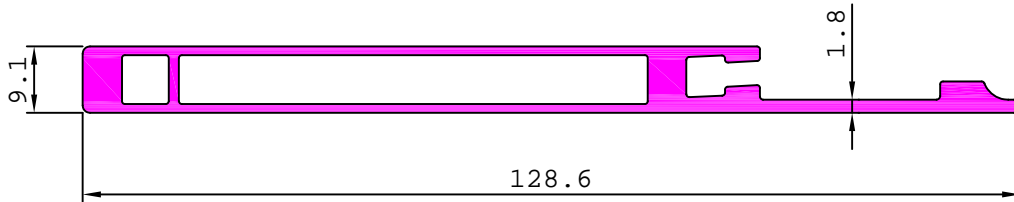

24893

0.924 kg/m

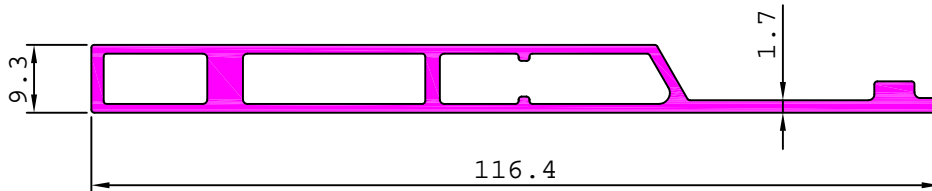

TEXTILE MACHINERY

24776

10.430 kg/m

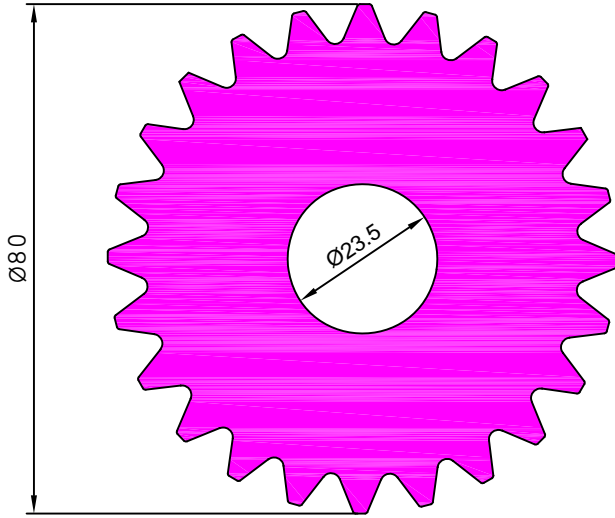

24768

11.712 kg/m

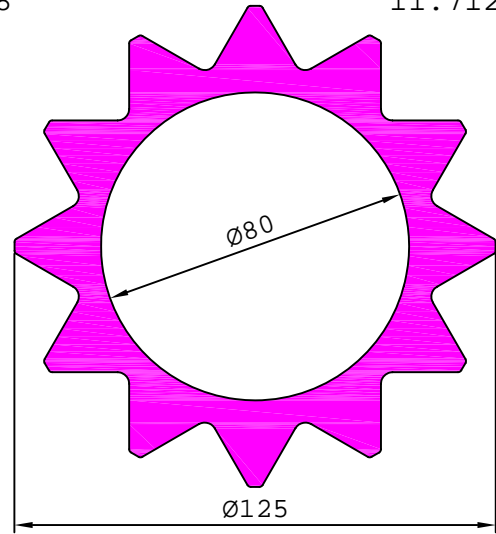

24824

6.306 kg/m

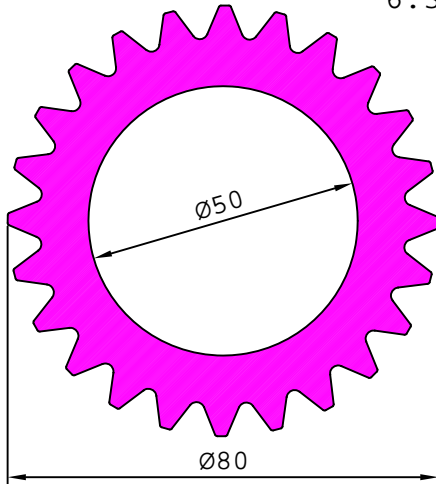

24762

1.479 kg/m

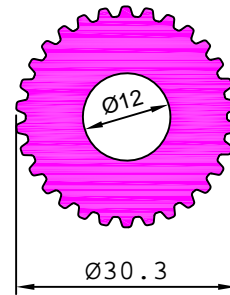

24763

8.057 kg/m

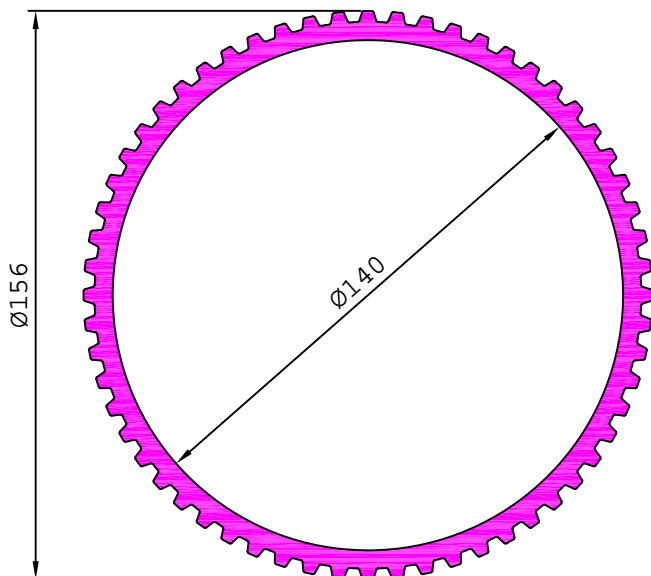

24764

7.803 kg/m

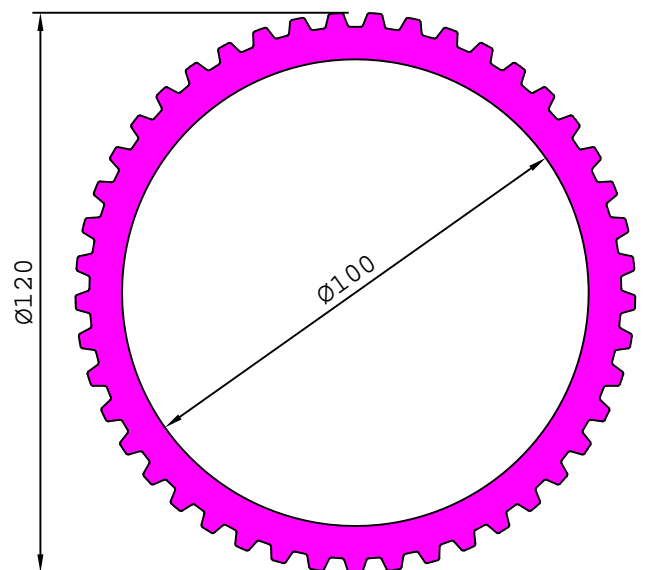

TEXTILE MACHINERY

24874

11.527 kg/m

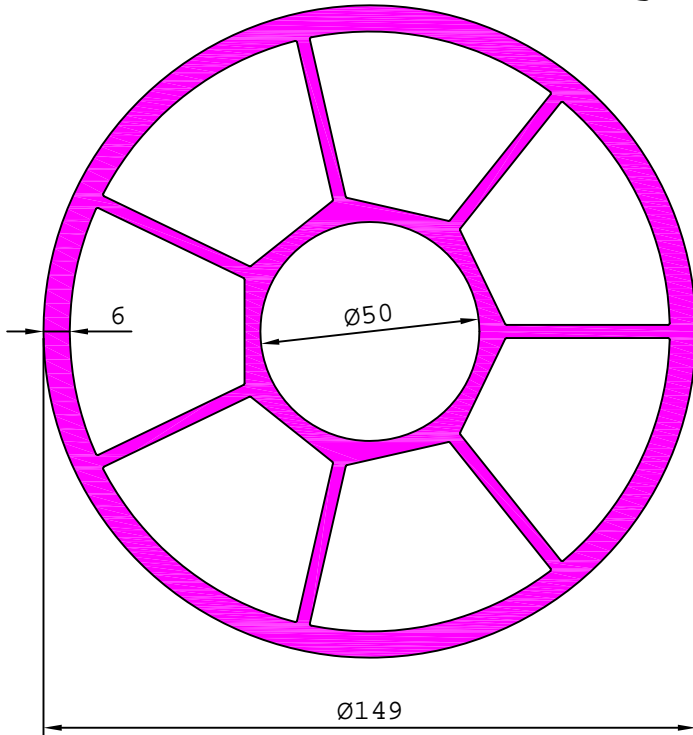

24885

3.728 kg/m

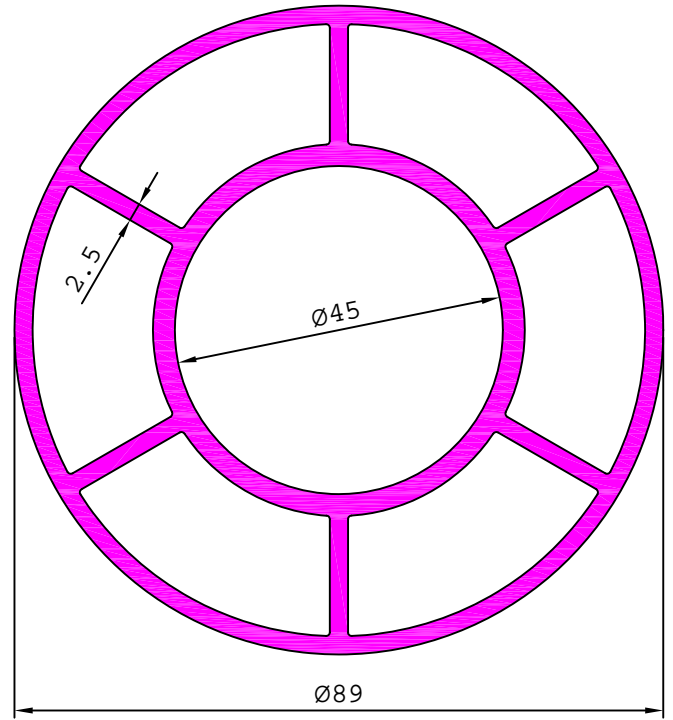

S4981

12.709 kg/m

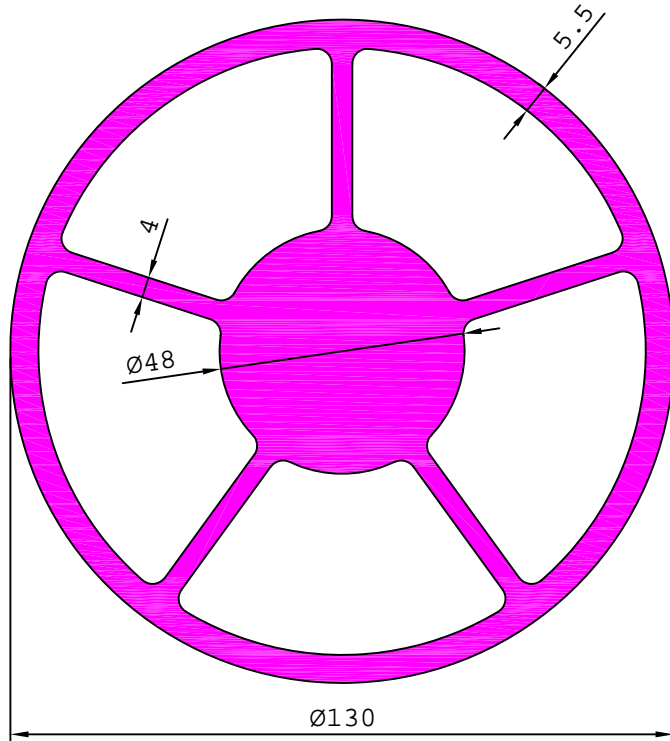

S4982

5.675 kg/m

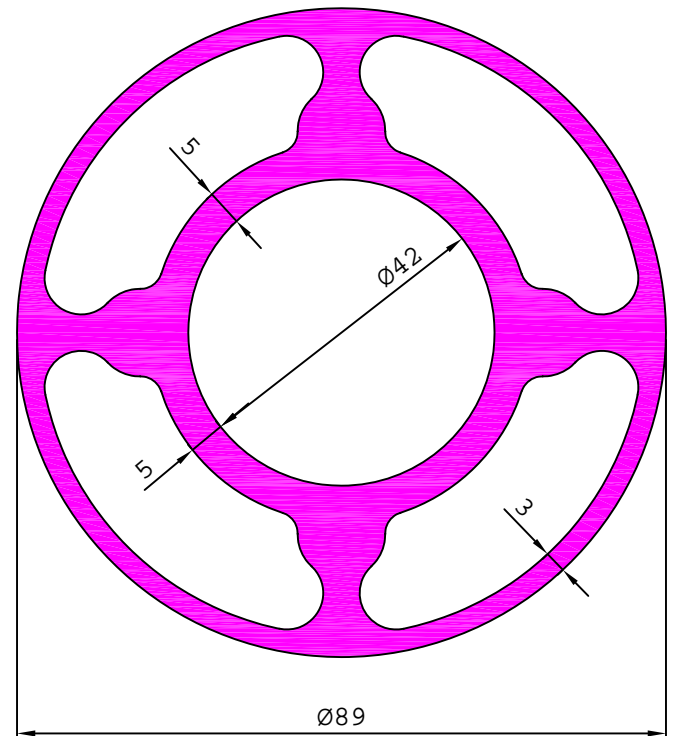

S4838

0.290 kg/m

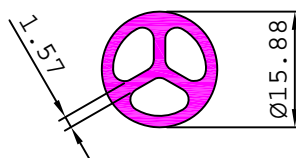

TEXTILE MACHINERY

S4762

9.575 kg/m

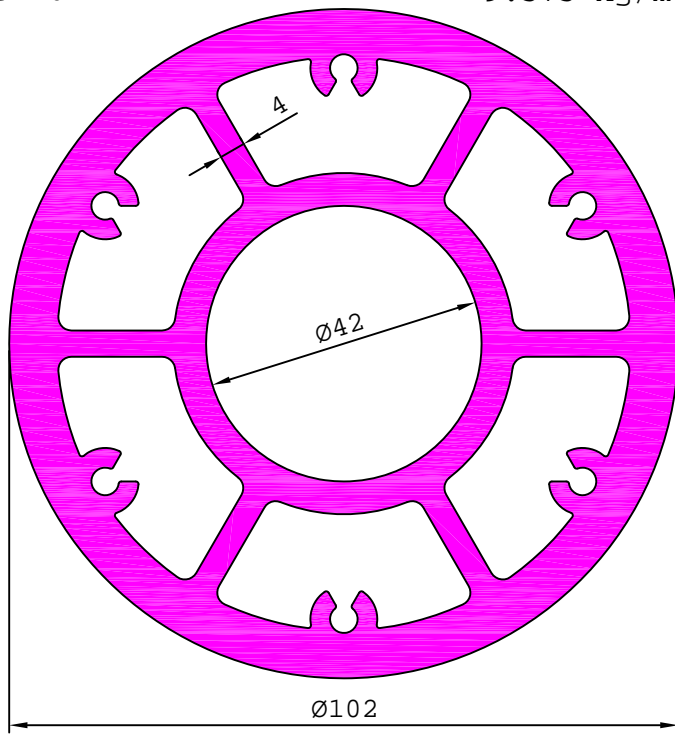

TEXTILE MACHINERY

24820

2.692 kg/m

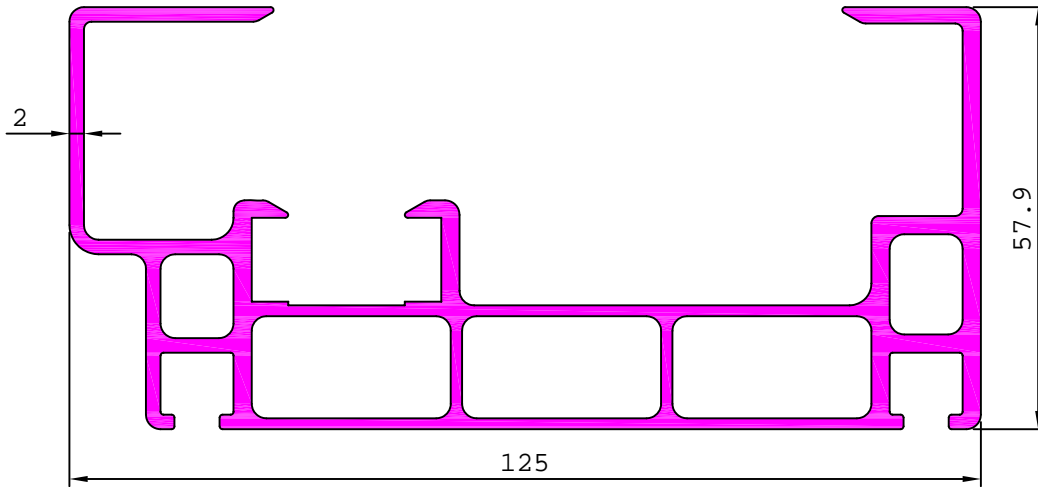

24829

2.691 kg/m

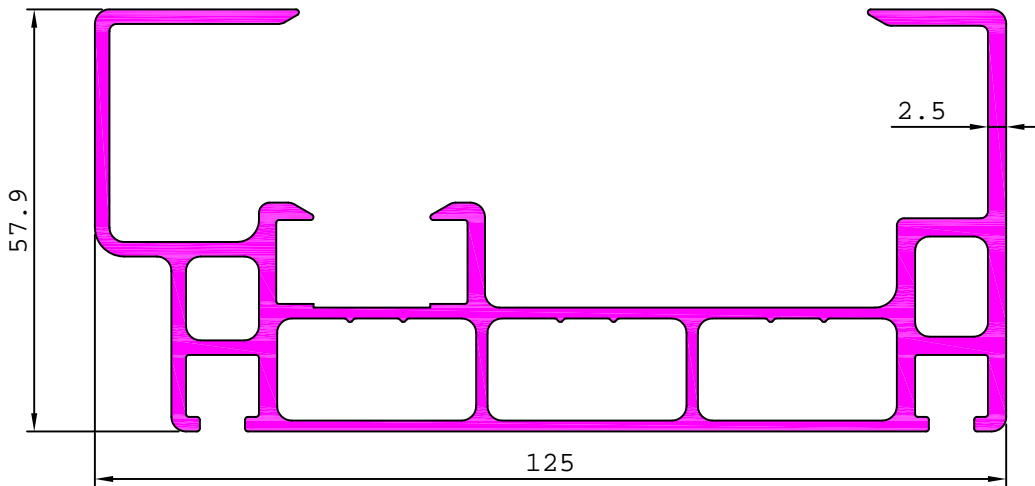

24798

2.722 kg/m

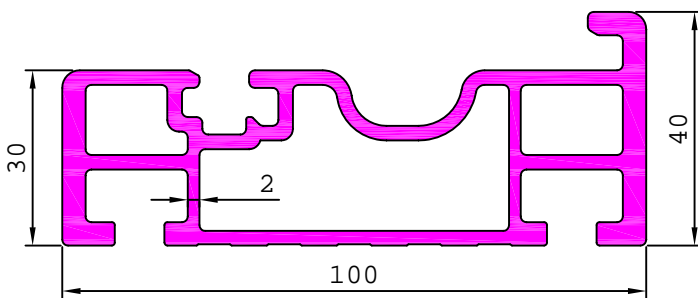

24835

3.063 kg/m

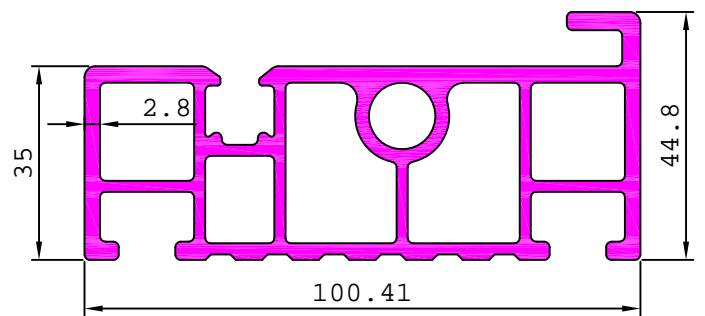

24809

2.332 kg/m

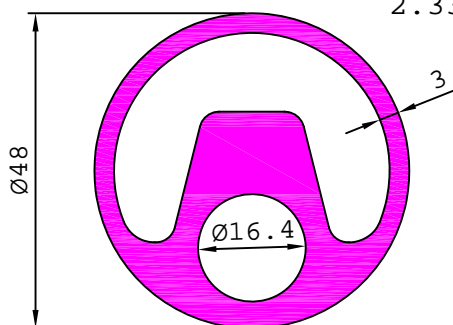

24834

0.822 kg/m

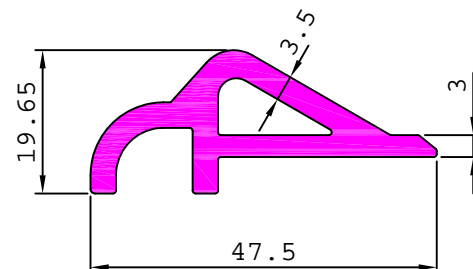

TEXTILE MACHINERY

24791

4.106 kg/m

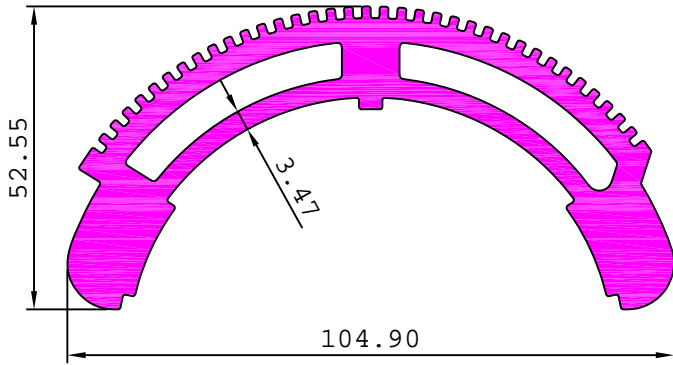

24795

3.695 kg/m

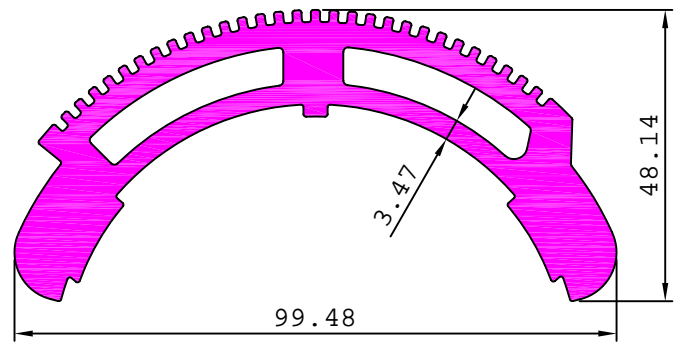

24731

2.223 kg/m

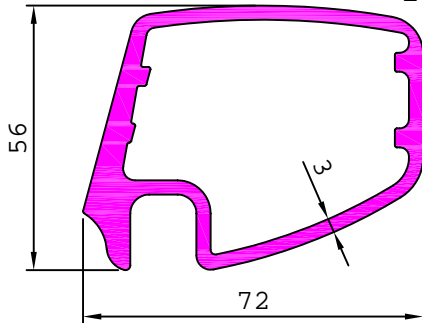

24879

1.200 kg/m

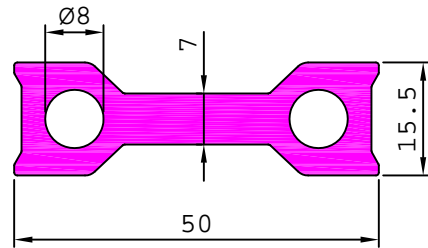

S4947

1.221 kg/m

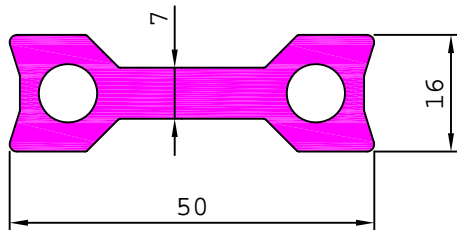

TEXTILE MACHINERY

24788

1.907 kg/m

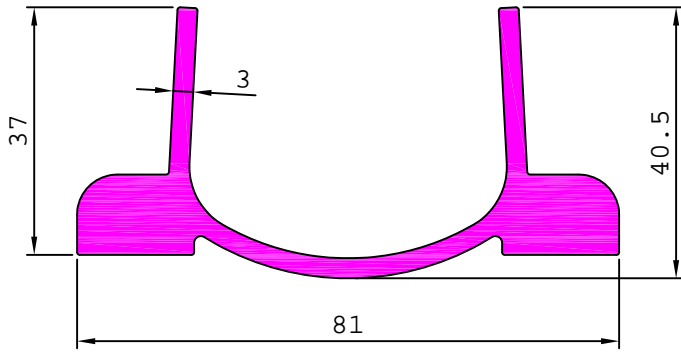

24833

2.099 kg/m

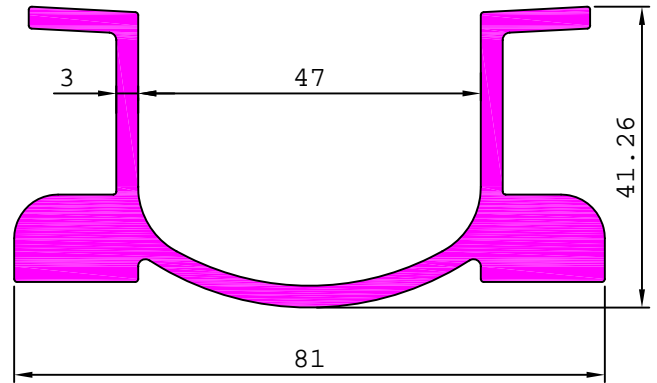

24845

3.574 kg/m

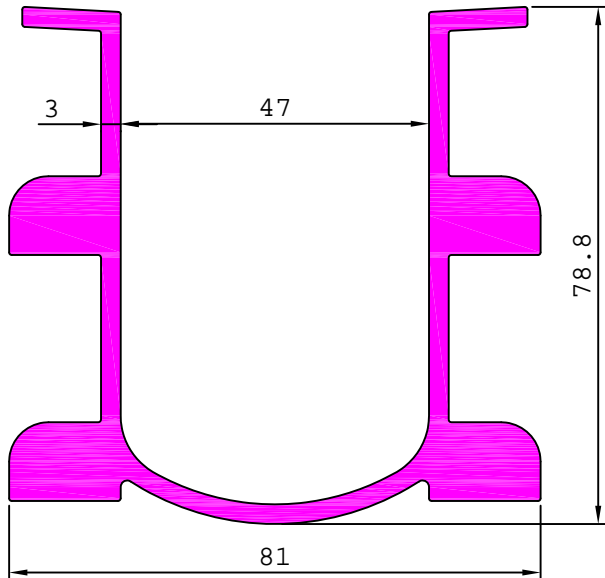

TEXTILE MACHINERY

24860

0.206 kg/m

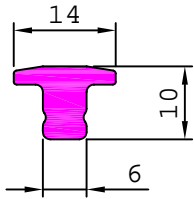

24734

0.534 kg/m

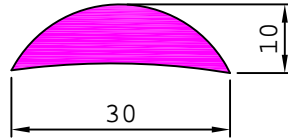

24736

0.772 kg/m

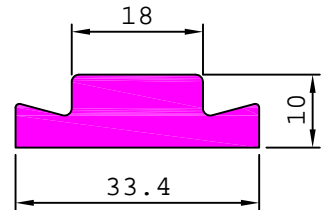

24739

1.224 kg/m

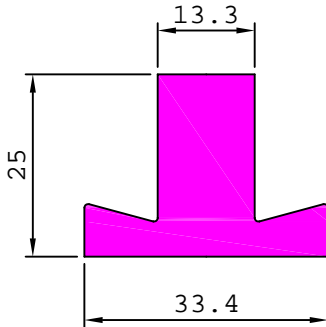

24746

0.724 kg/m

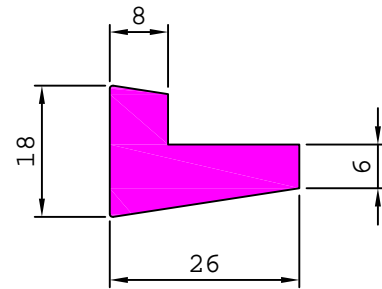

24759

0.609 kg/m

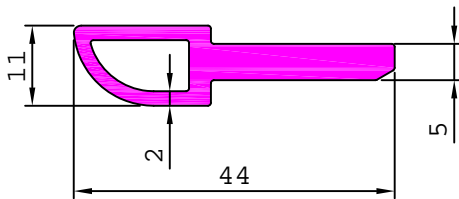

24790

0.538 kg/m

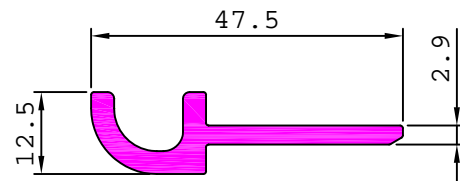

24830

0.431 kg/m

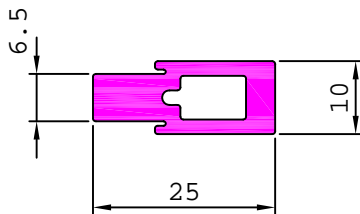

24786

1.357 kg/m

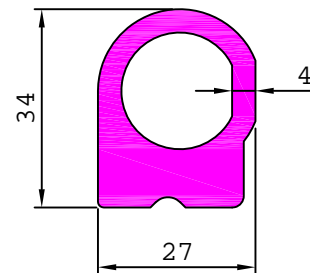

24745

1.986 kg/m

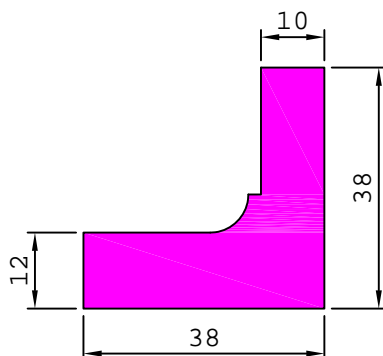

24777

2.800 kg/m

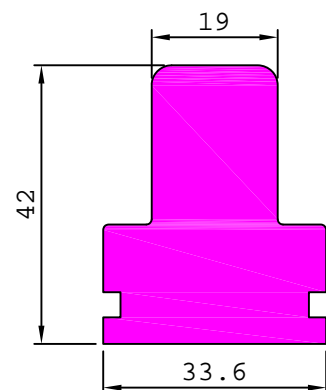

TEXTILE MACHINERY

24781

2.132 kg/m

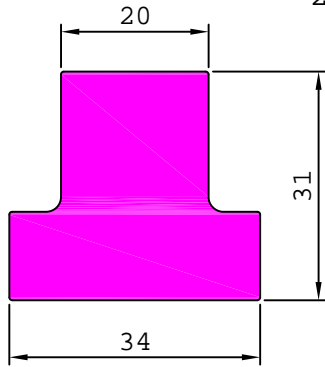

24737

2.434 kg/m

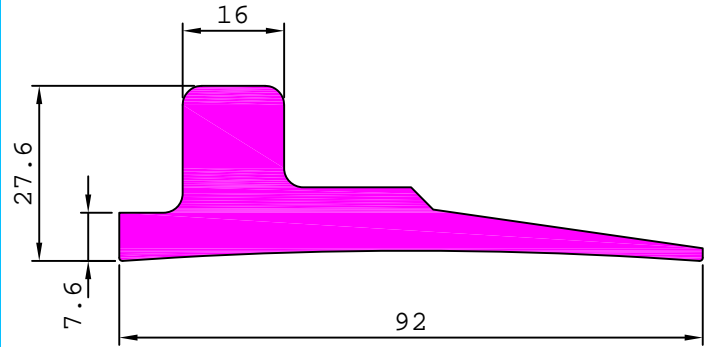

24740

5.797 kg/m

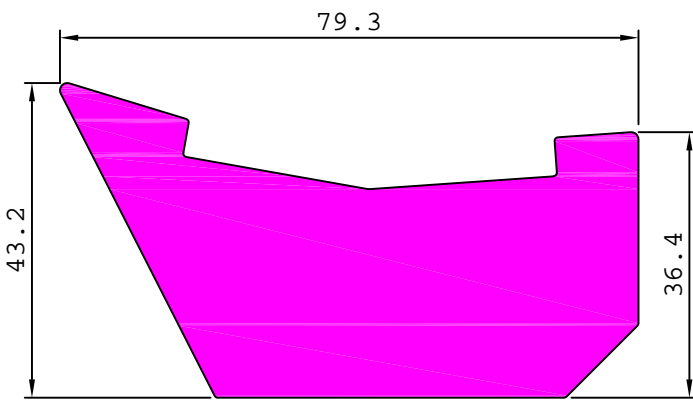

24769

12.824 kg/m

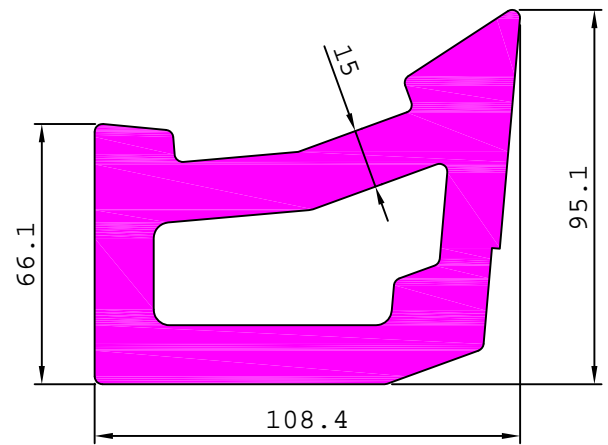

24770

9.505 kg/m

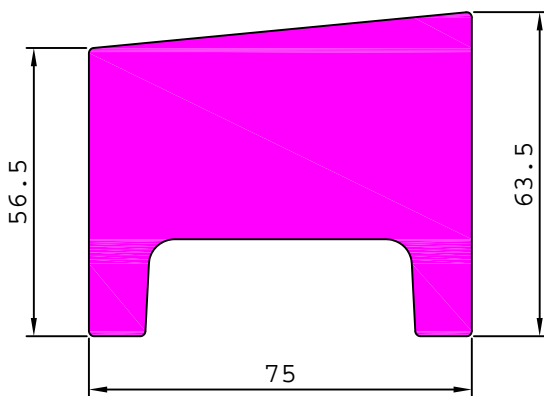

24799

5.042 kg/m

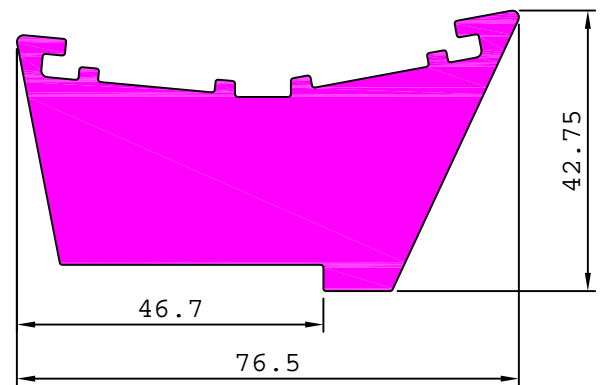

24774

5.946 kg/m

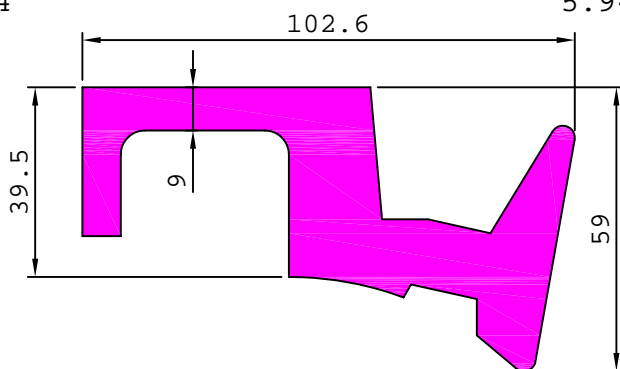

24787

2.143 kg/m

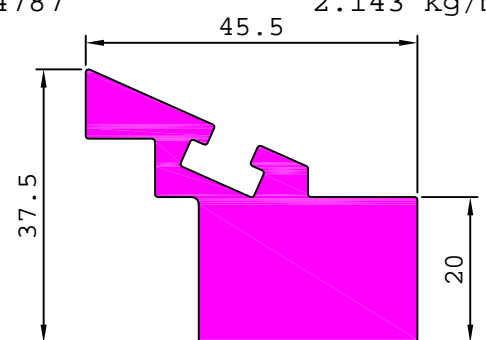

TEXTILE MACHINERY

24801 76.8 7.022 kg/m

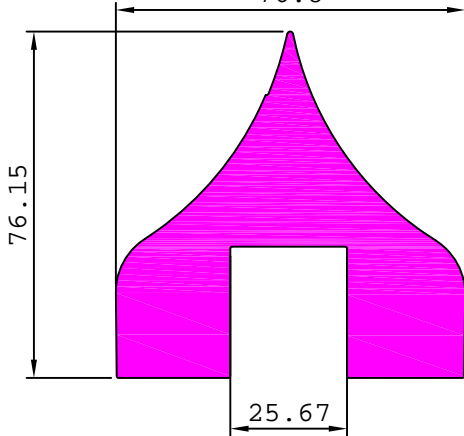

24828 5.523 kg/m

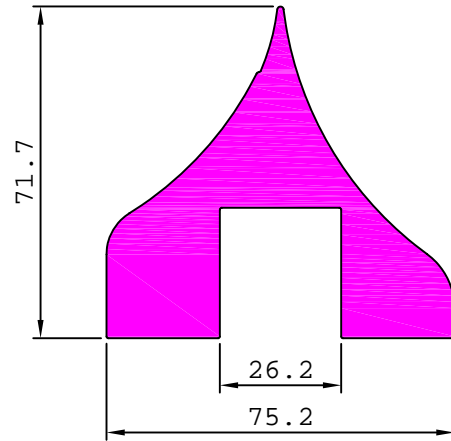

24823 4.265 kg/m

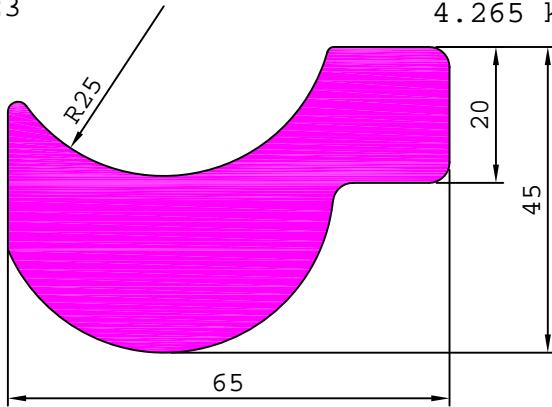

24843 2.912 kg/m

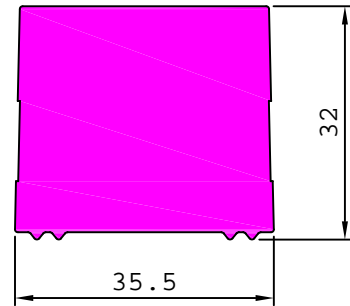

24881 5.541 kg/m

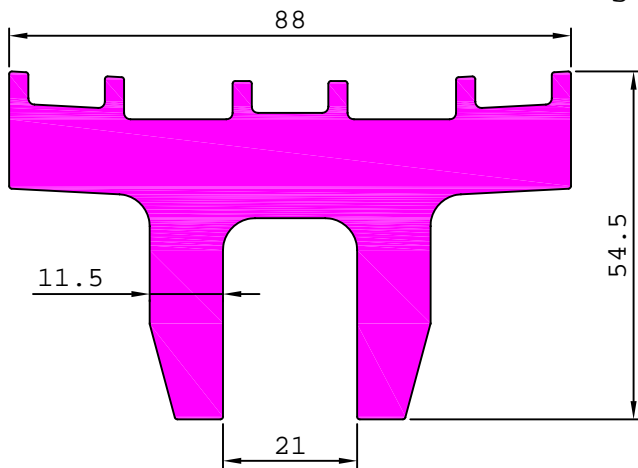

24870 4.152 kg/m

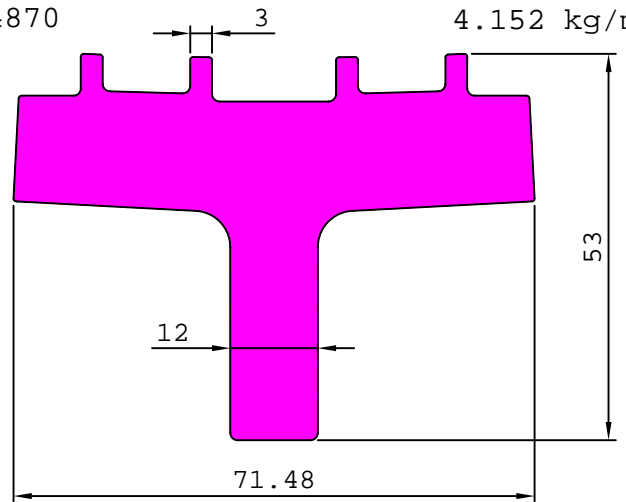

24867 4.094 kg/m

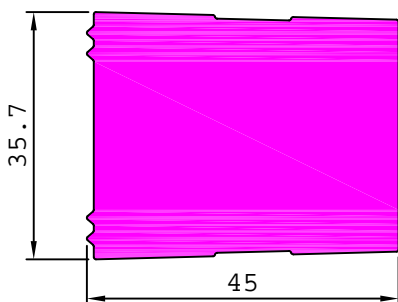

24884 0.560 kg/m

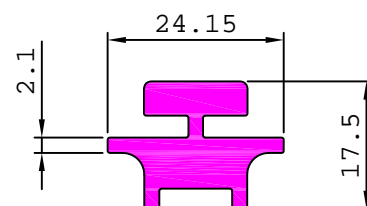

TEXTILE MACHINERY

24844 2.743 kg/m

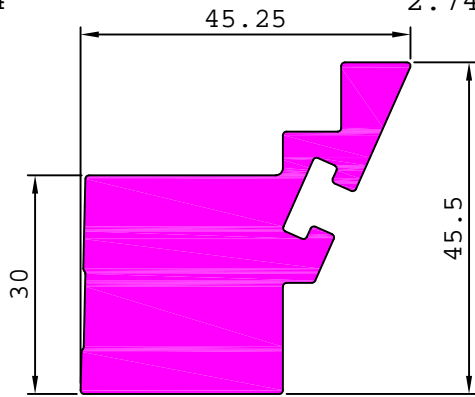

28253 2.711 kg/m

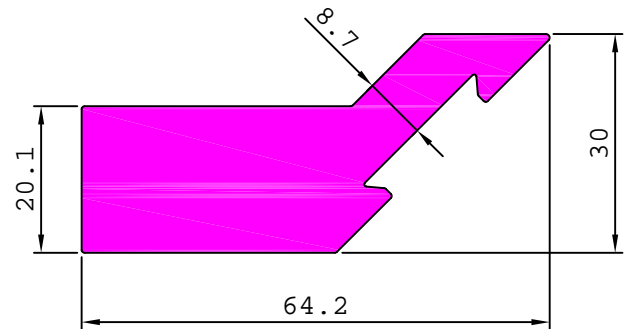

S4317 0.592 kg/m

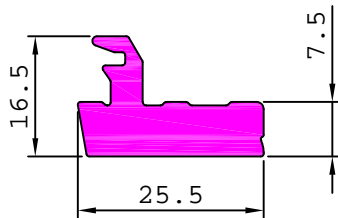

S4817 1.839 kg/m

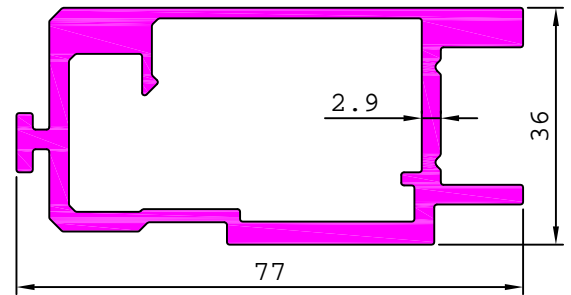

S4712 8.005 kg/m

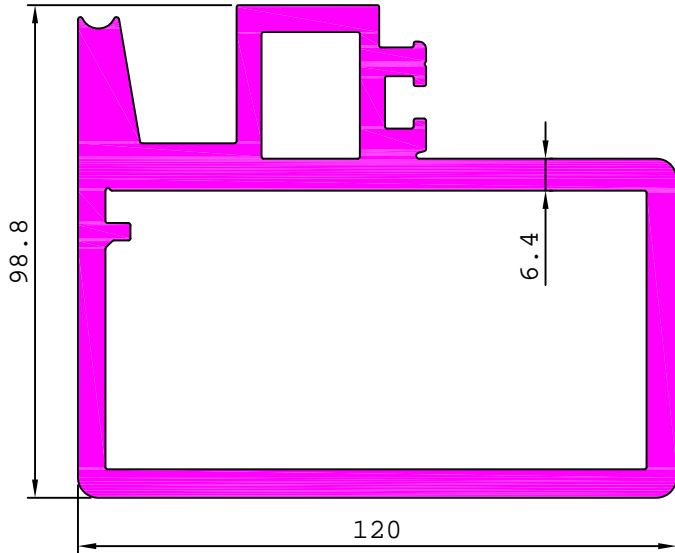

S5060 4.992 kg/m

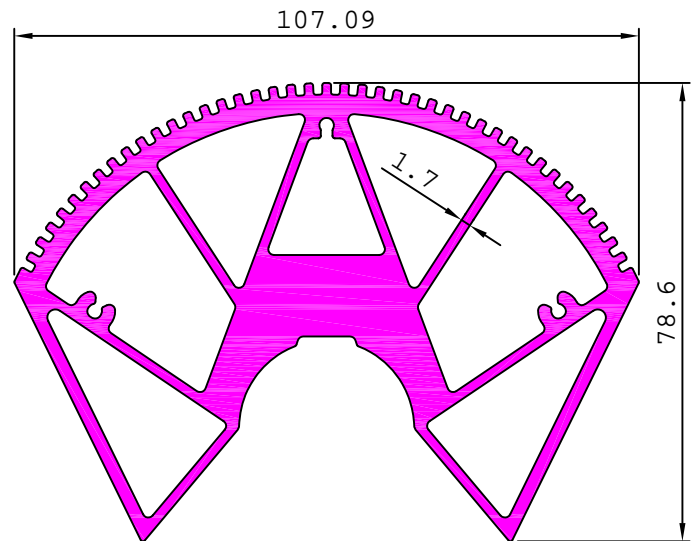

S4338 3.535 kg/m

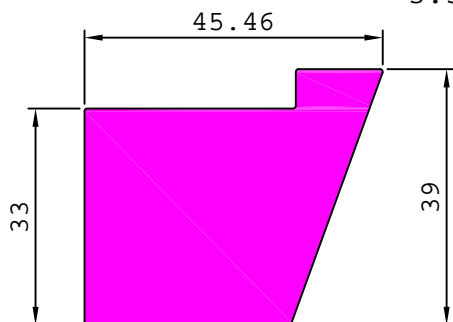

S5320 0.168 kg/m

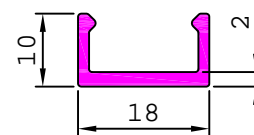

S5321 0.082 kg/m

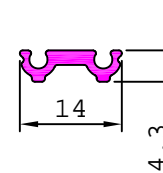

TEXTILE MACHINERY

S5380

2.800 kg/m

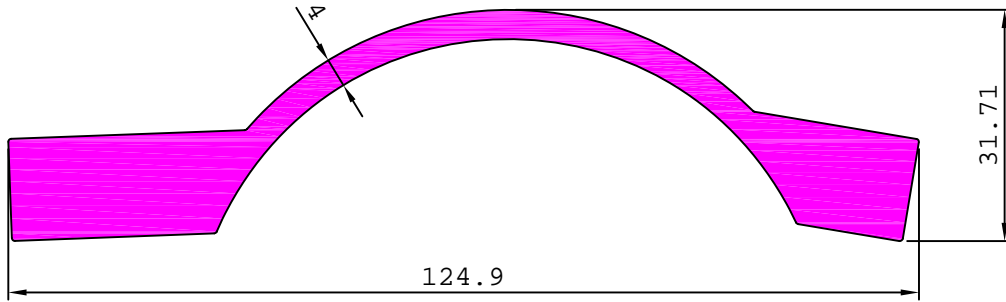

S5363

0.819 kg/m

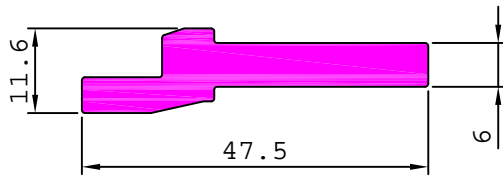

S5318

1.771 kg/m

