

REFRIGERATION SECTION

26504

2.292 kg/m

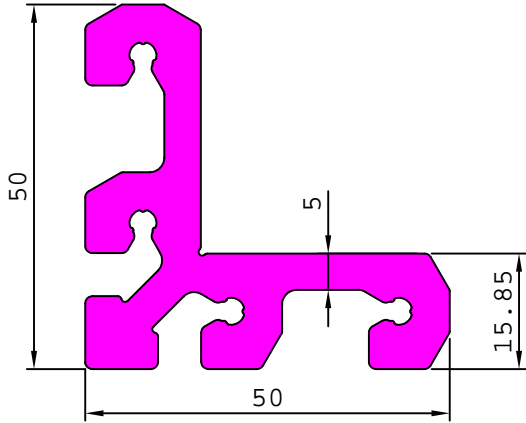

26663

3.173 kg/m

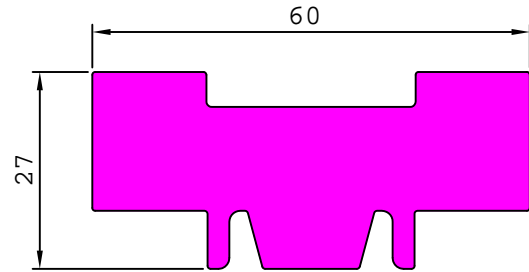

26664

2.547 kg/m

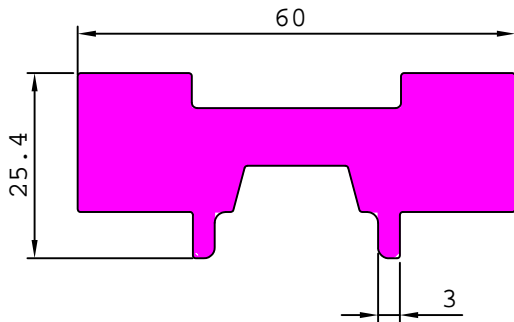

26823

1.268 kg/m

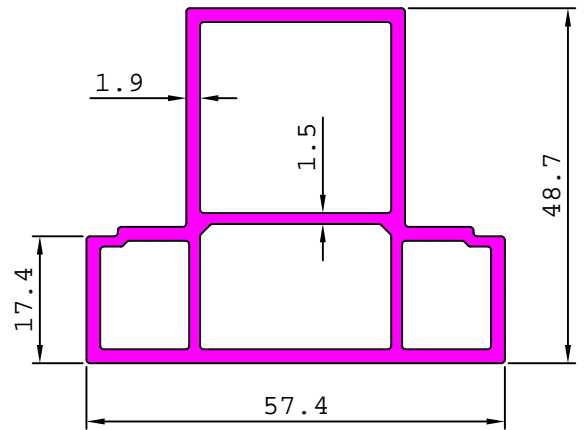

26839

0.717 kg/m

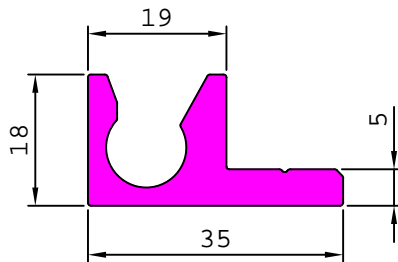

26840

0.886 kg/m

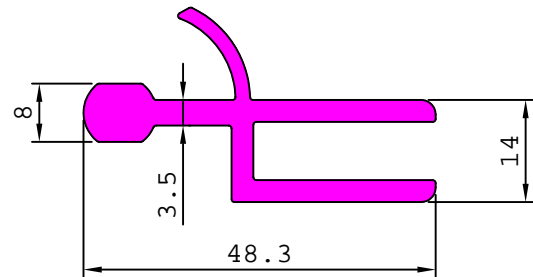

26849

0.850 kg/m

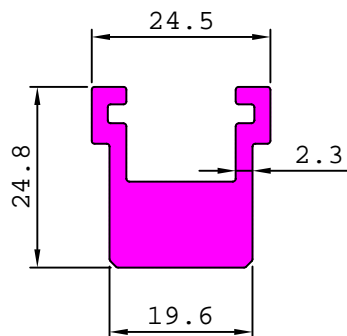

26850

1.327 kg/m

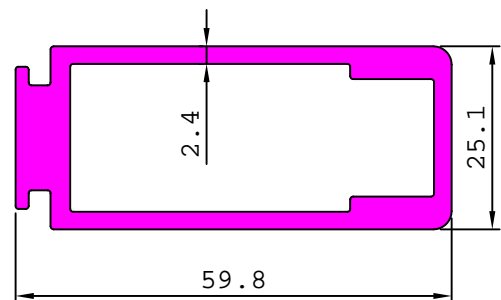

REFRIGERATION SECTION

26851 1.078 kg/m

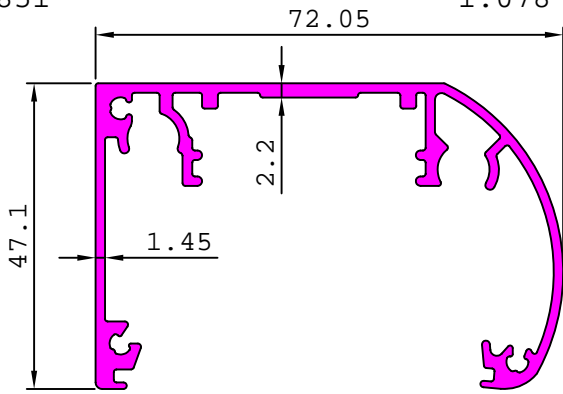

26857 0.526 kg/m

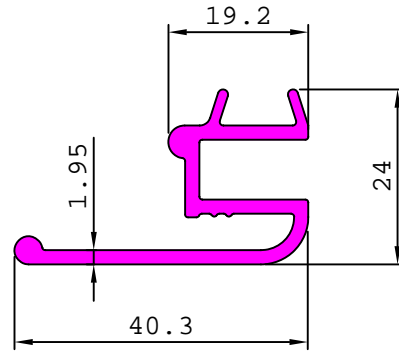

26858 0.777 kg/m

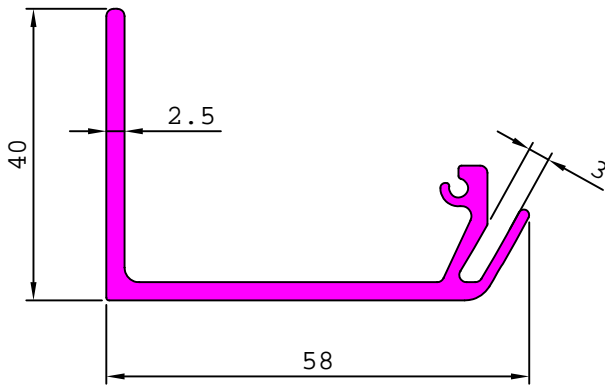

26859 1.181 kg/m

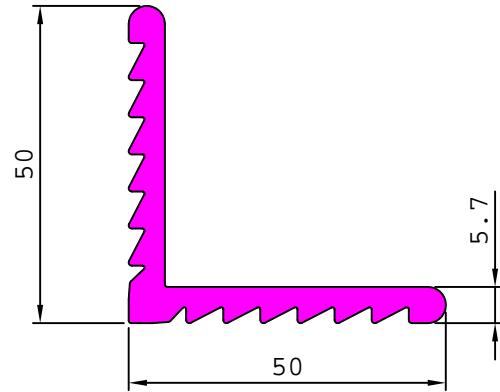

26860 0.267 kg/m

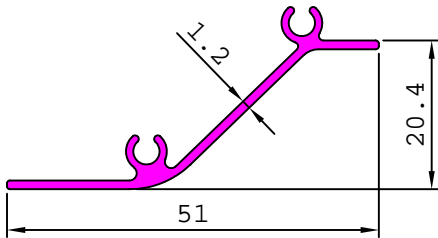

26868 0.155 kg/m

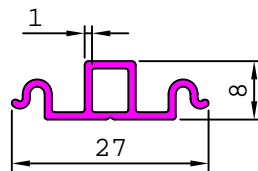

26874 0.347 kg/m

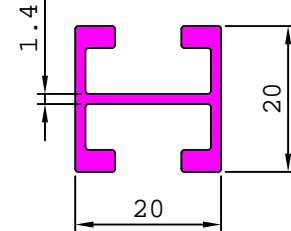

26870 1.724 kg/m

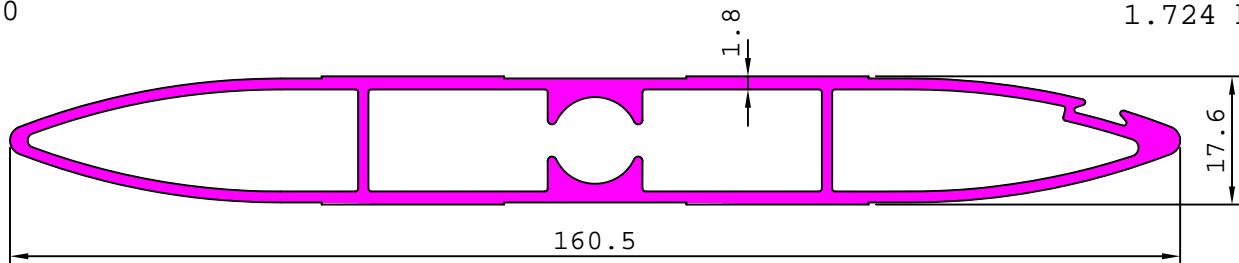

26875 0.160 kg/m

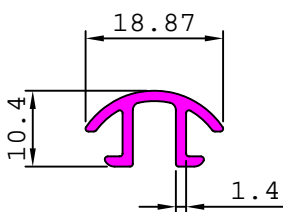

26876 1.050 kg/m

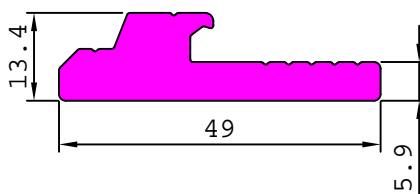

26878 0.429 kg/m

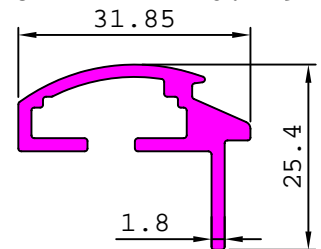

REFRIGERATION SECTION

26877

0.783 kg/m

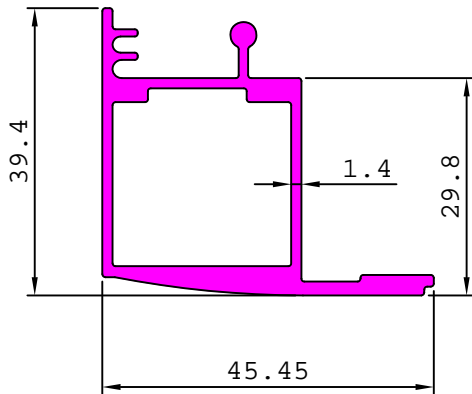

26879

0.795 kg/m

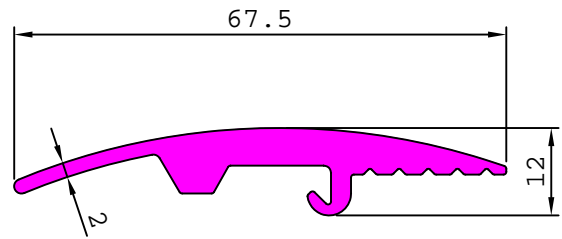

26880

0.897 kg/m

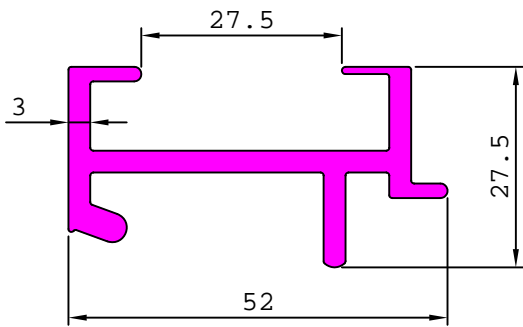

29210

0.855 kg/m

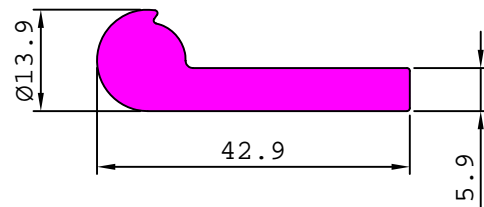

29211

0.740 kg/m

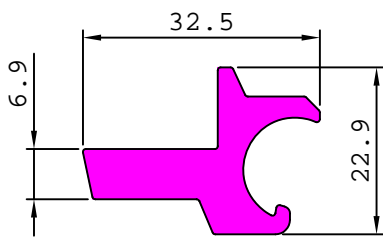

26894

0.656 kg/m

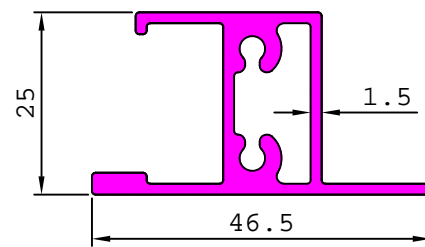

26914

2.479 kg/m

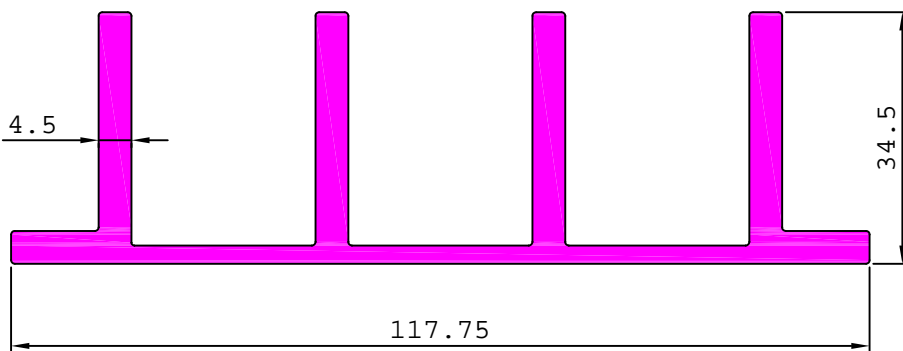

26916

1.489 kg/m

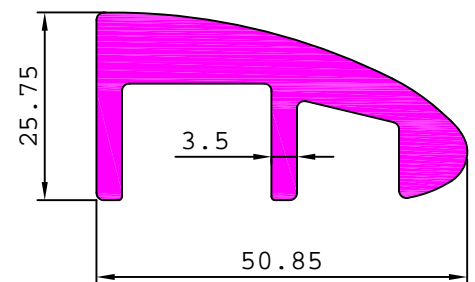

REFRIGERATION SECTION

26915

0.995 kg/m

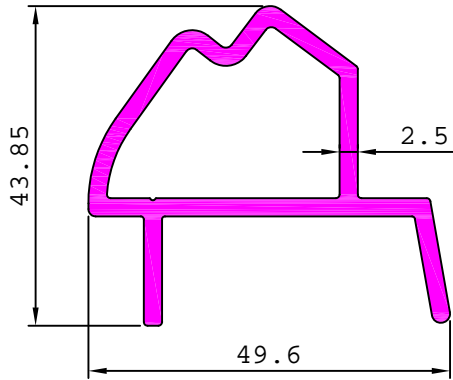

26922

1.060 kg/m

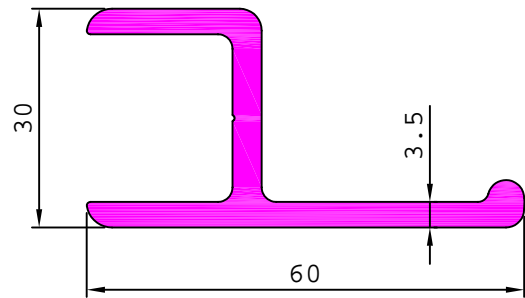

26918

0.770 kg/m

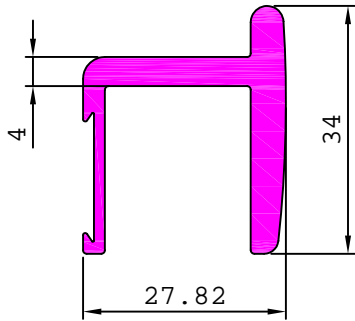

26919

2.410 kg/m

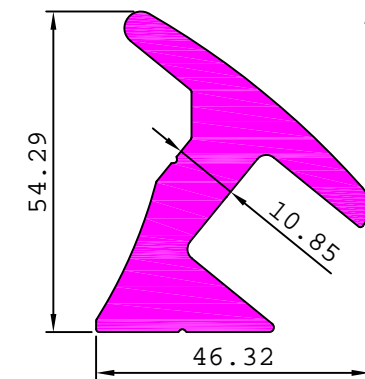

26920

0.974 kg/m

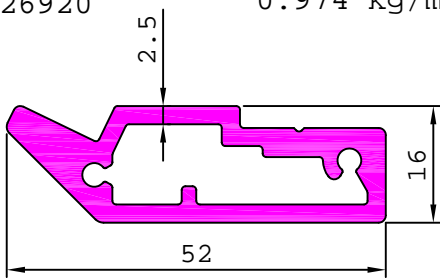

26917

0.818 kg/m

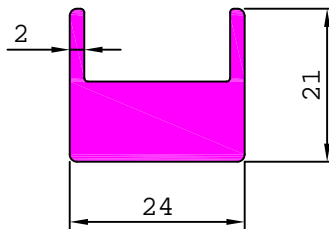

26921

0.124 kg/m

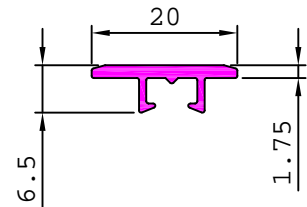

26923

0.084 kg/m

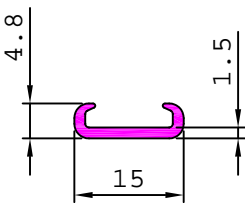

26924

11.619 kg/m

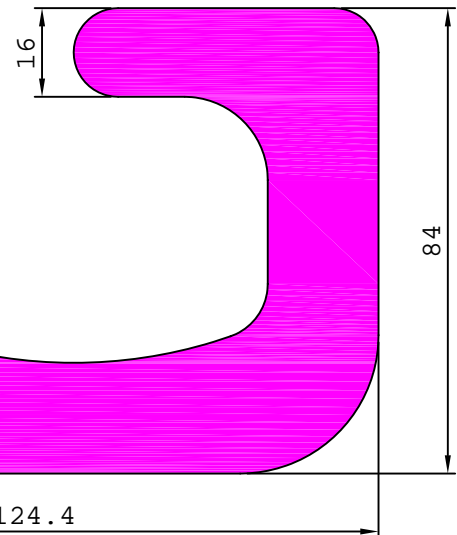

26926

0.760 kg/m

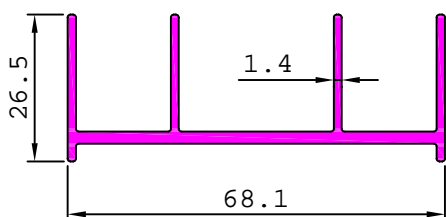

REFRIGERATION SECTION

26927 0.561 kg/m

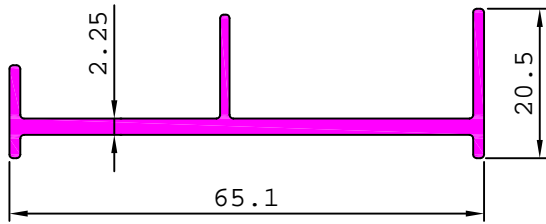

26928 0.561 kg/m

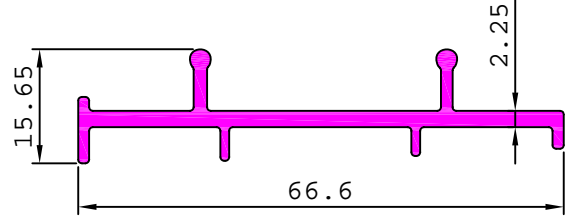

26929 0.709 kg/m

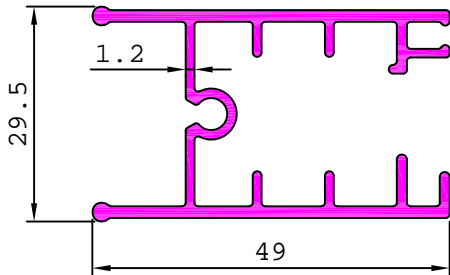

26930 0.344 kg/m

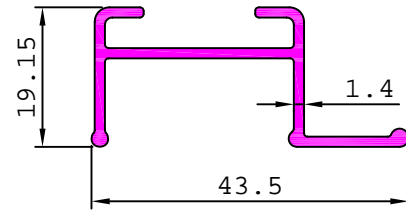

26931 0.279 kg/m

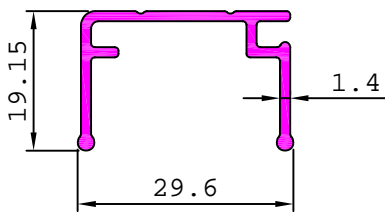

26934 0.377 kg/m

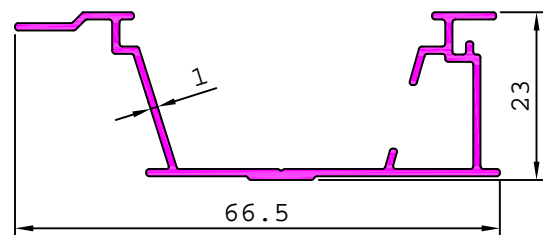

26932 0.510 kg/m

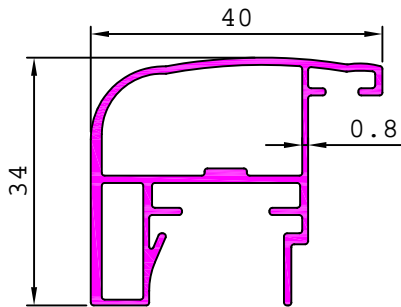

26933 0.673 kg/m

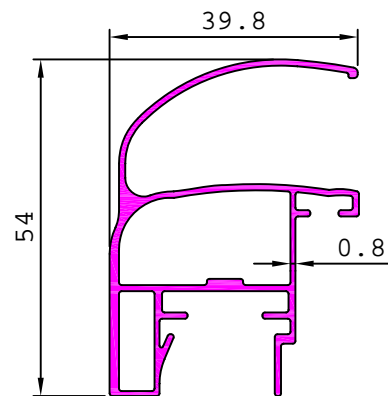

26935 0.949 kg/m

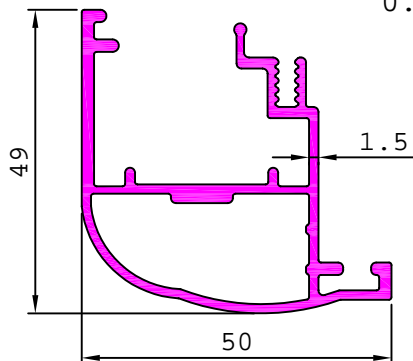

26936 0.658 kg/m

