

TUBES

MISCELLANEOUS TUBES

15101

1.230 kg/m

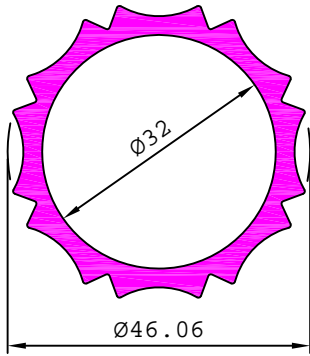

15106

0.164 kg/m

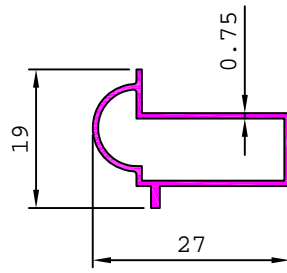

15109

0.460 kg/m

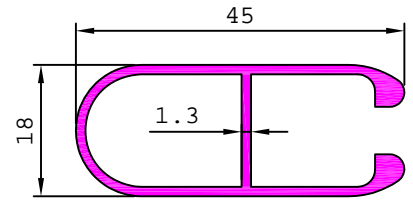

15117

4.478 kg/m

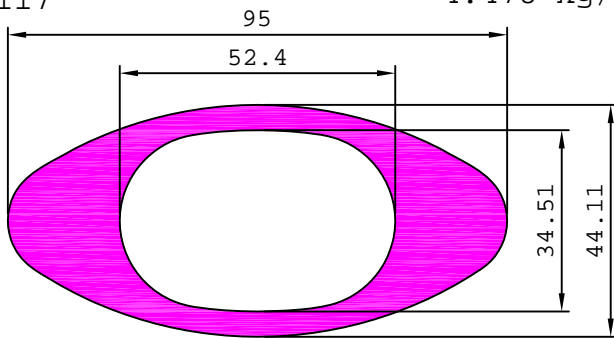

15125

1.111 kg/m

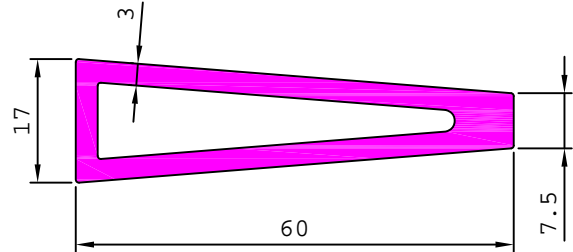

15118

1.570 kg/m

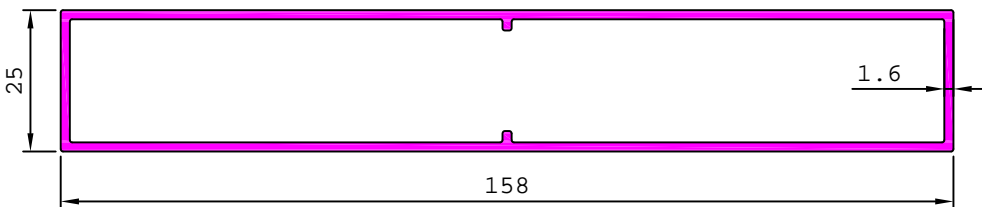

15121

0.075 kg/m

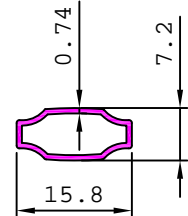

15130

0.621 kg/m

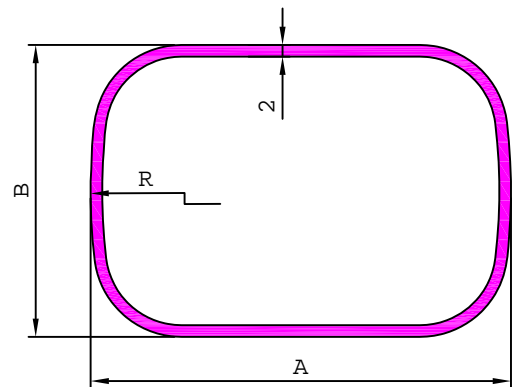
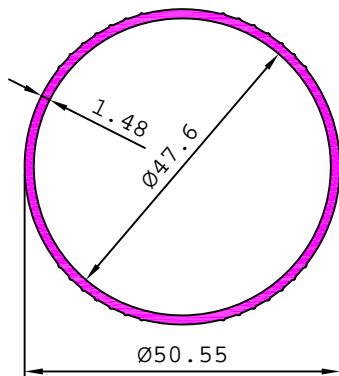

15135

0.869 kg/m

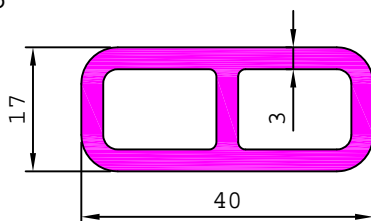

SL. No.	Section No.	A	B	R	Weight kg/m
1	15140	72.00	50.00	100.00	1.132
2	15141	50.00	40.00	50.00	0.804
2	15164	62.75	42.00	84.00	0.988

MISCELLANEOUS TUBES

15136

0.137 kg/m

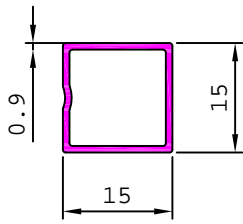

15148

0.575 kg/m

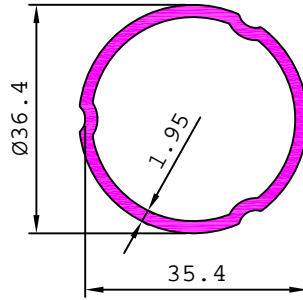

15156

0.329 kg/m

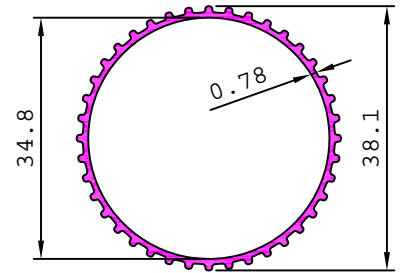

15145

4.780 kg/m

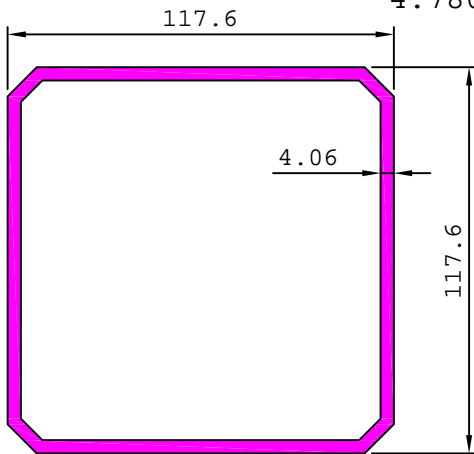

15175

2.894 kg/m

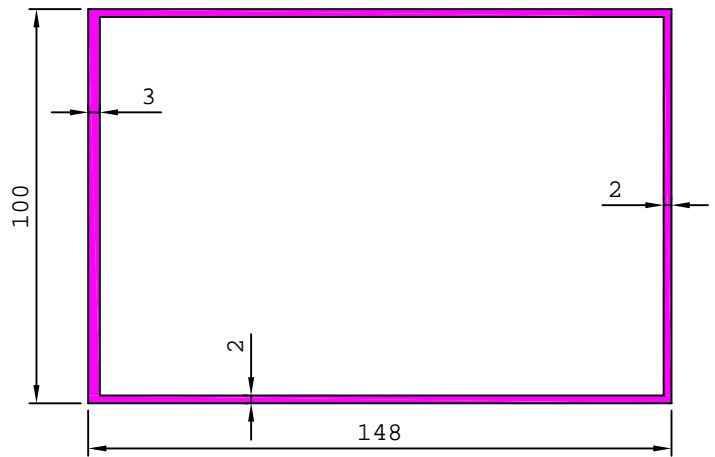

15150

0.300 kg/m

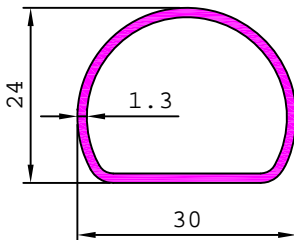

15152

0.271 kg/m

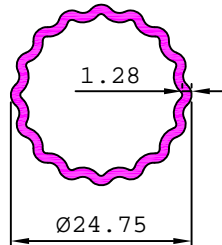

15163

0.310 kg/m

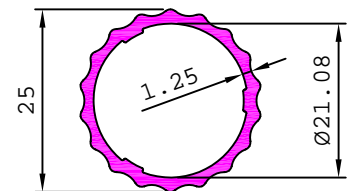

15167

0.087 kg/m

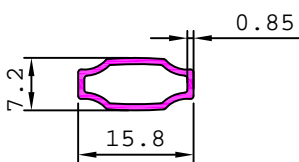

15176

0.282 kg/m

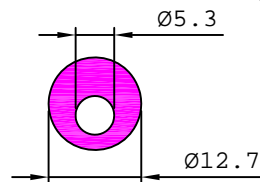

15190

0.058 kg/m

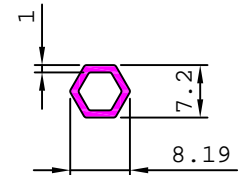

15188

1.704 kg/m

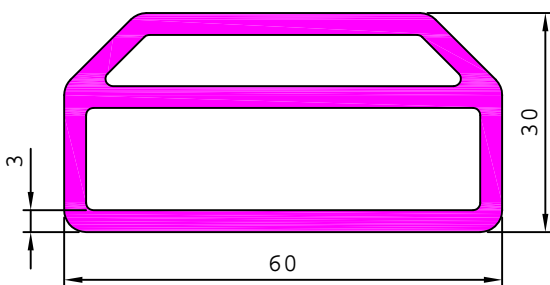

15181

0.984 kg/m

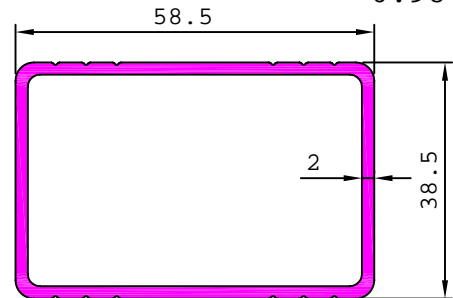

MISCELLANEOUS TUBES

15180 4.780 kg/m

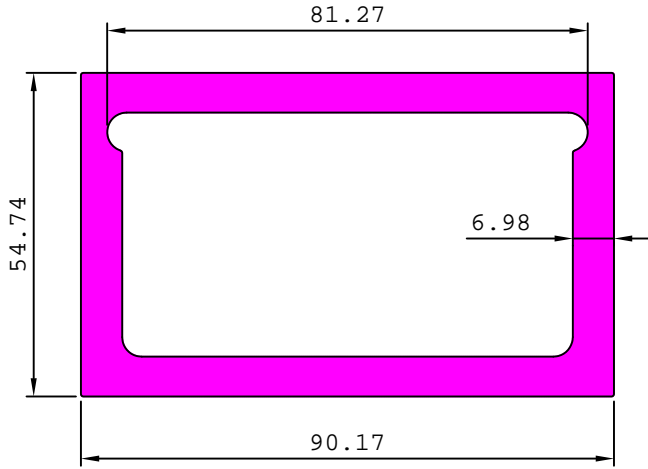

15199 0.700 kg/m

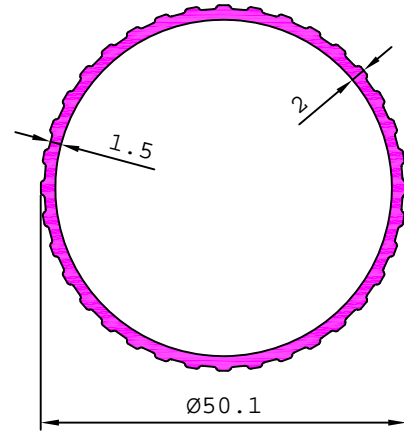

15203 0.391 kg/m

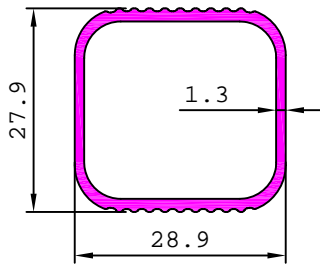

15204 0.377 kg/m

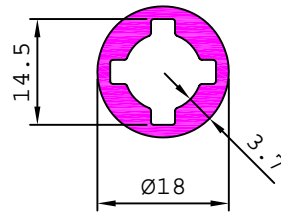

15215 0.287 kg/m

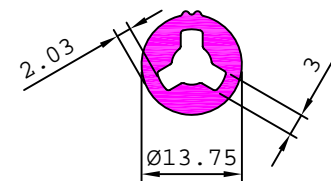

15205 0.944 kg/m

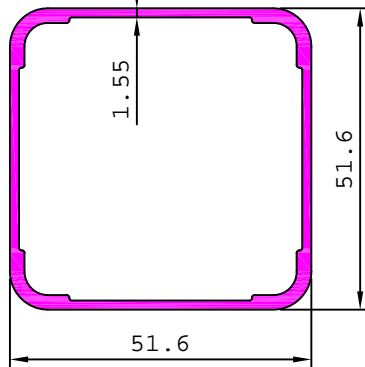

15206 1.119 kg/m

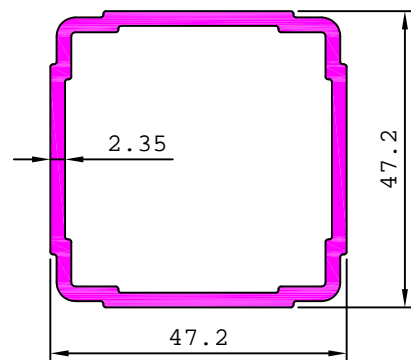

15202 0.695 kg/m

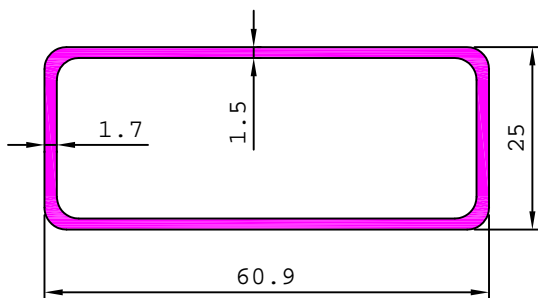

15210 7.375 kg/m

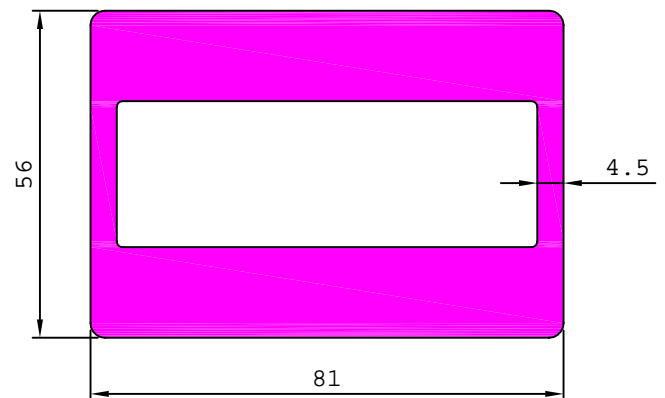

MISCELLANEOUS TUBES

15216 69.928 kg/m

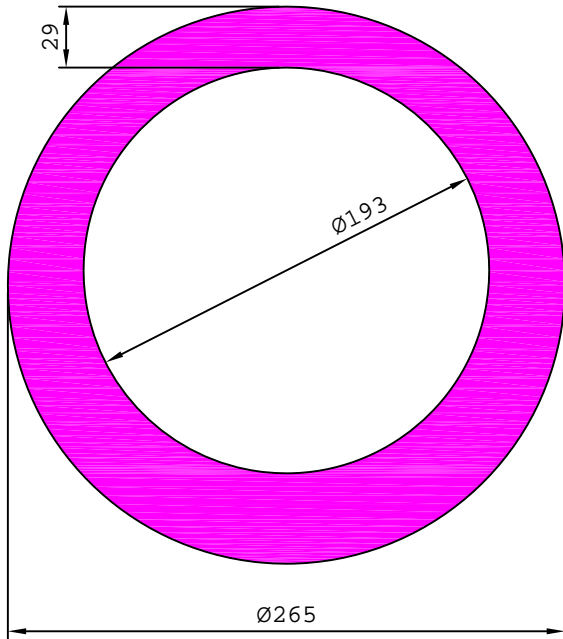

15217 21.131 kg/m

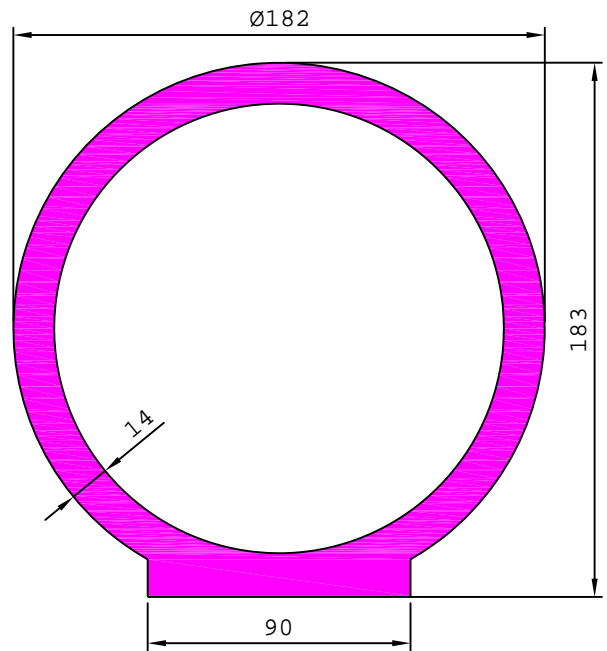

15218 1.350 kg/m

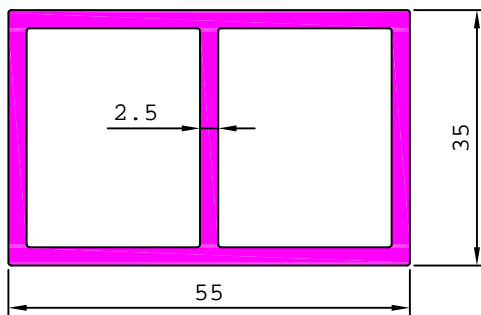

15219 1.509 kg/m

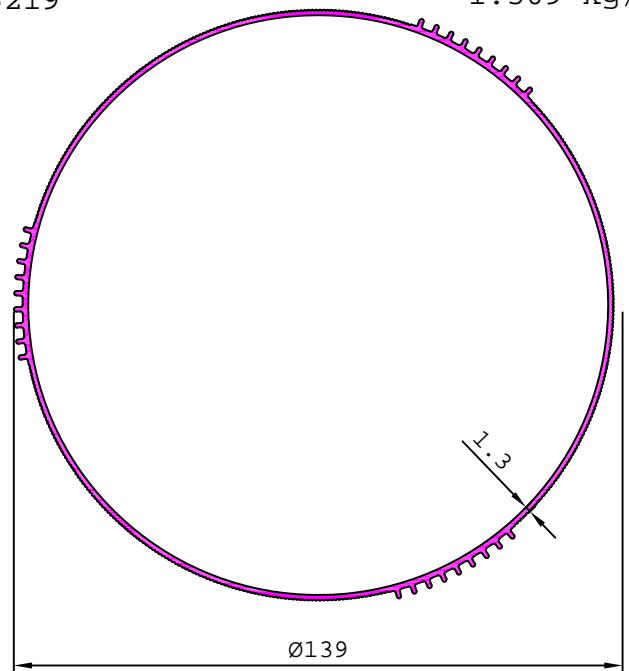

15222 0.962 kg/m

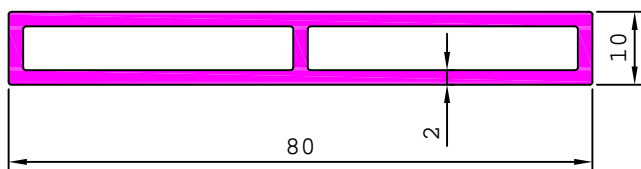

15227 2.676 kg/m

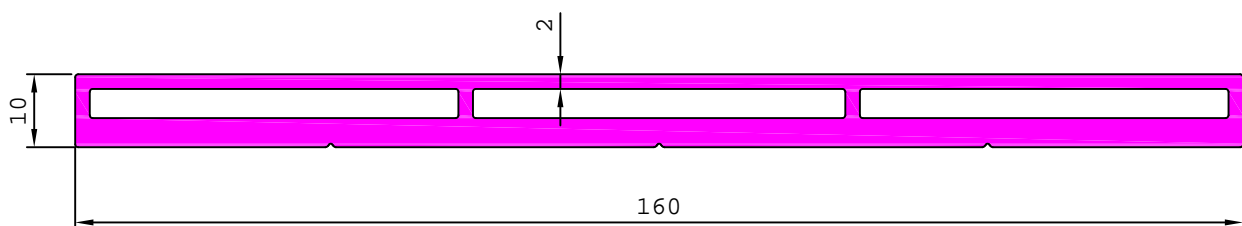

MISCELLANEOUS TUBES

15223 0.298 kg/m

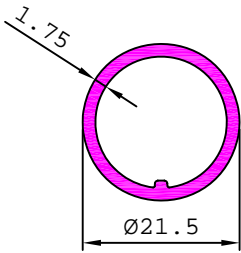

15224 0.852 kg/m

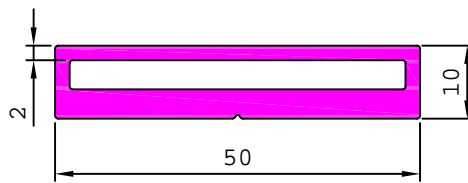

15233 0.307 kg/m

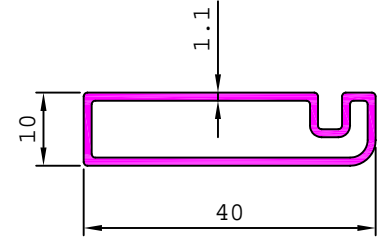

15225 1.501 kg/m

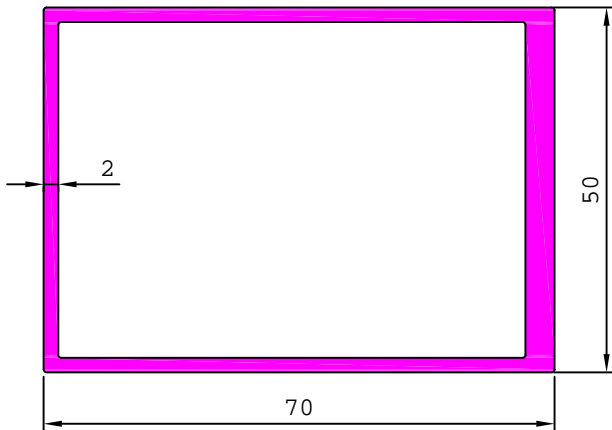

15234 0.488 kg/m

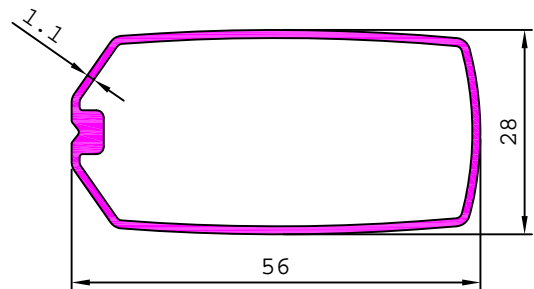

15240 0.504 kg/m

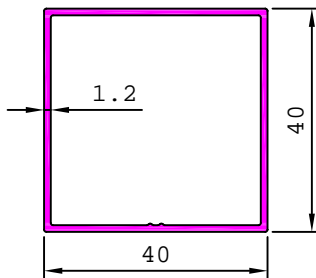

15235 0.333 kg/m

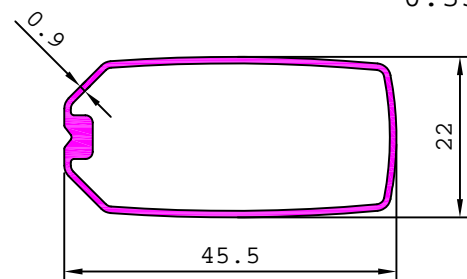

15236 0.161 kg/m

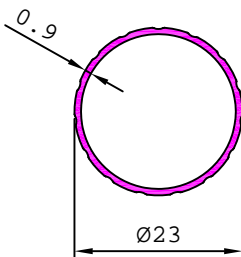

15237 0.172 kg/m

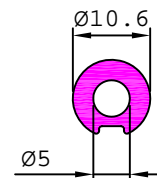

28654 0.713 kg/m

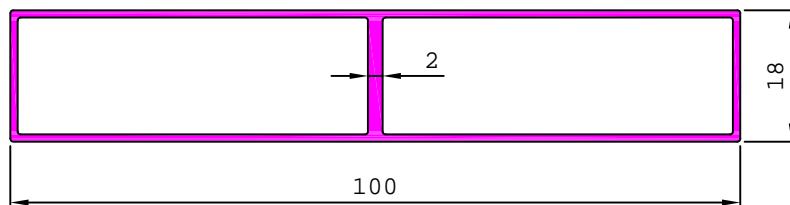

MISCELLANEOUS TUBES

15242

1.350 kg/m

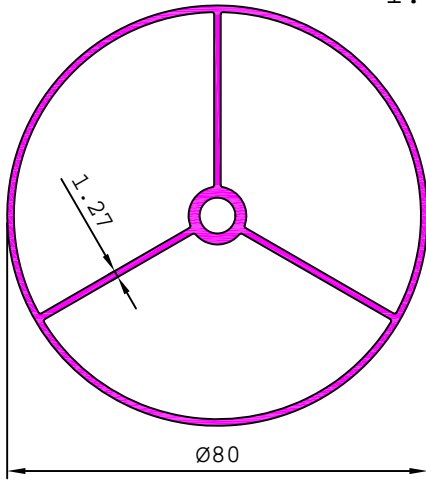

15243

0.207 kg/m

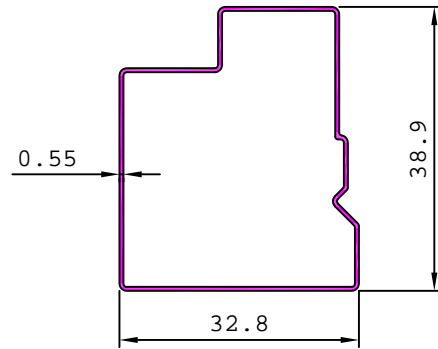

15244

81.729 kg/m

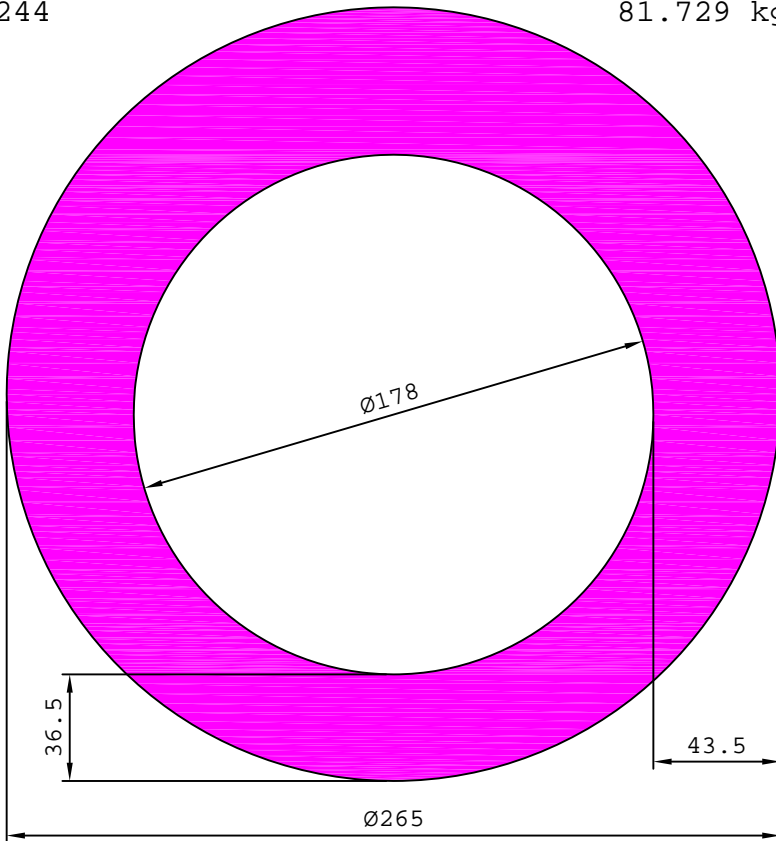

15246

0.488 kg/m

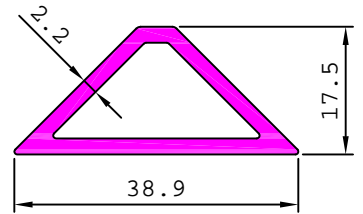

15248

1.768 kg/m

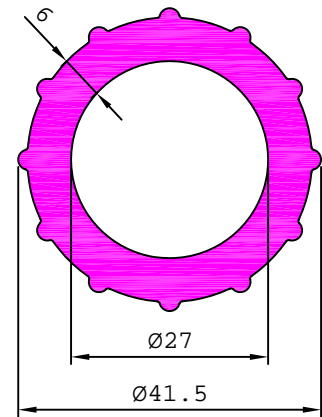

15250

0.322 kg/m

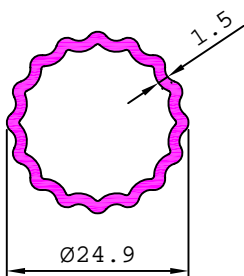

15253

0.738 kg/m

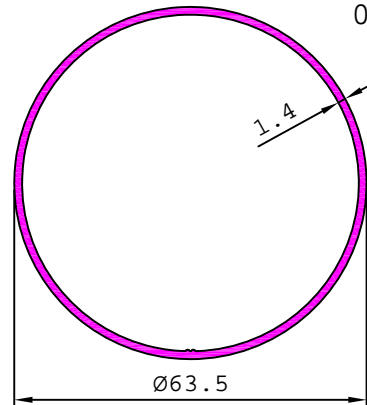

MISCELLANEOUS TUBES

15254

0.153 kg/m

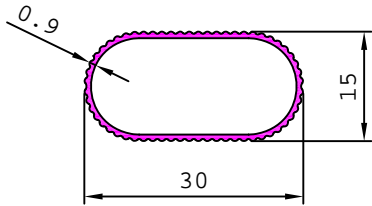

15255

0.175 kg/m

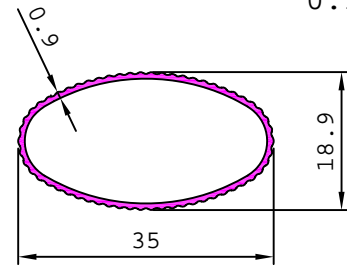

15257

0.761 kg/m

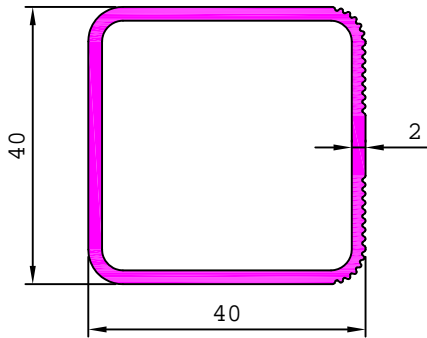

15262

0.330 kg/m

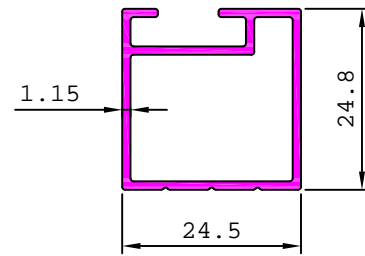

15259

5.104 kg/m

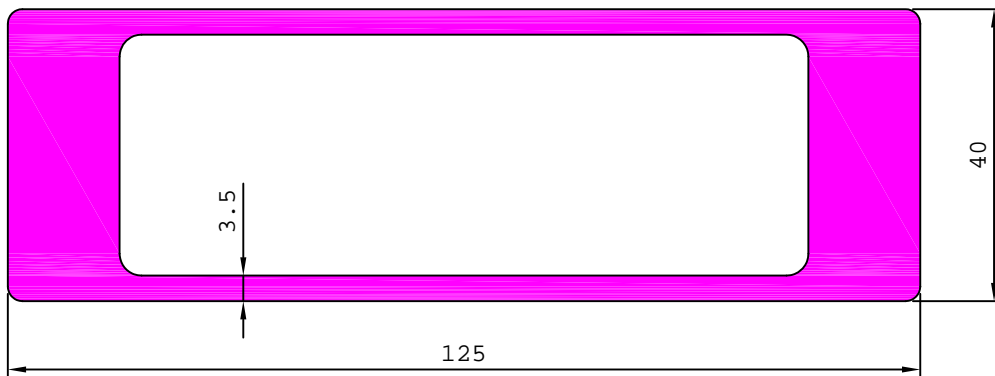

15261

2.887 kg/m

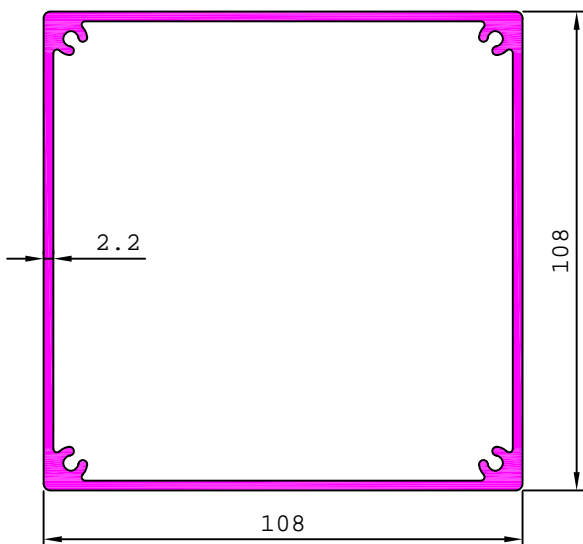

15263

2.330 kg/m

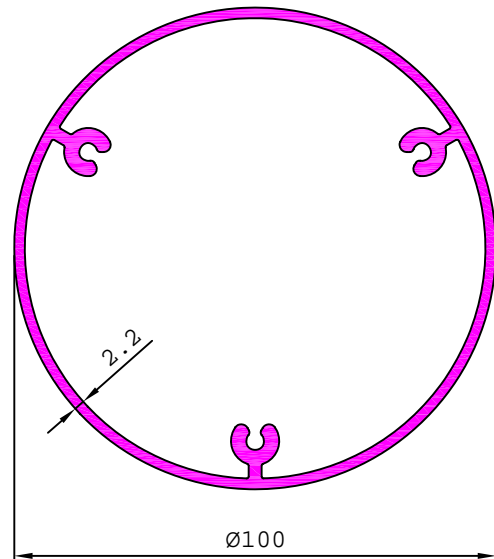

MISCELLANEOUS TUBES

15265

7.107 kg/m

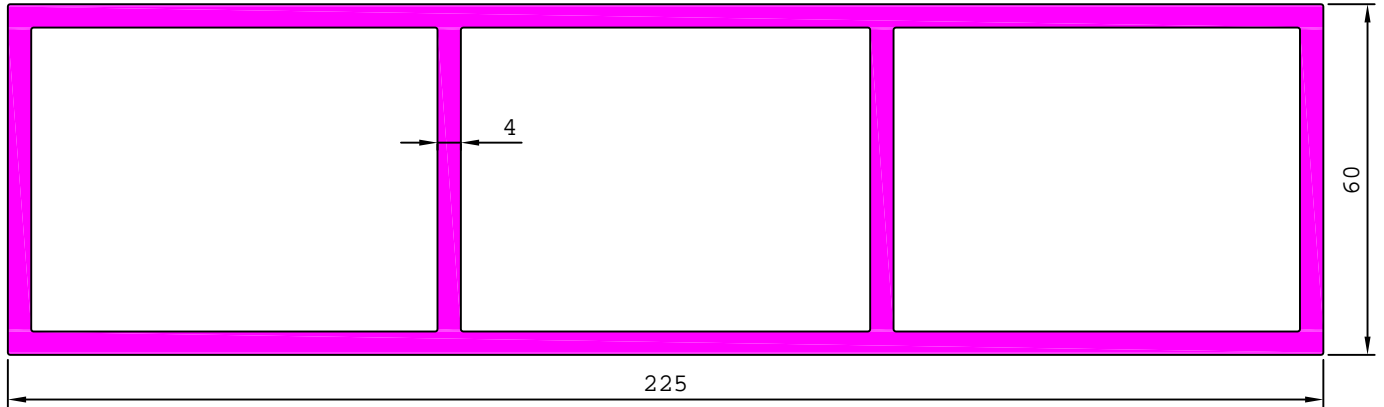

15268

0.846 kg/m

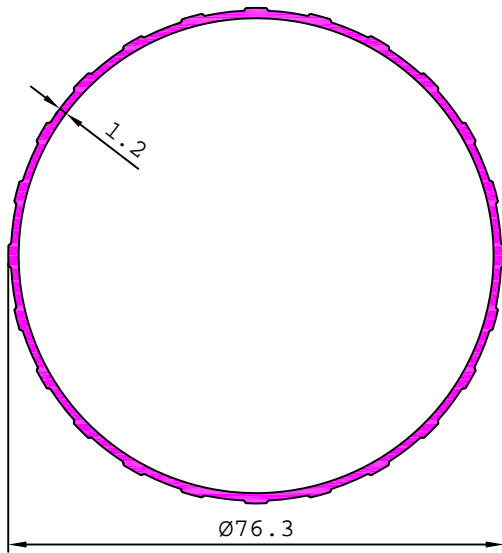

27612

2.984 kg/m

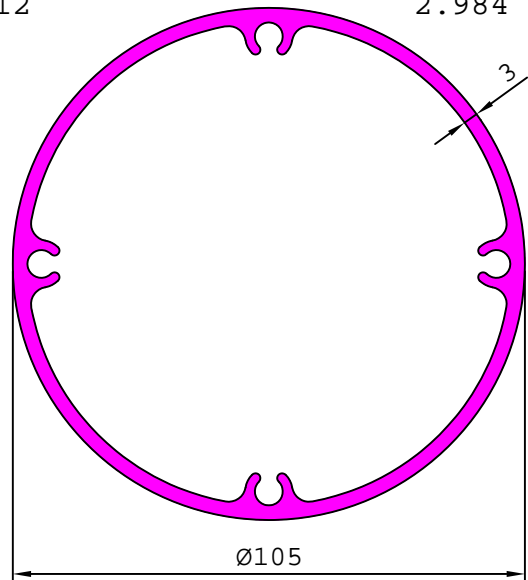

27518

4.200 kg/m

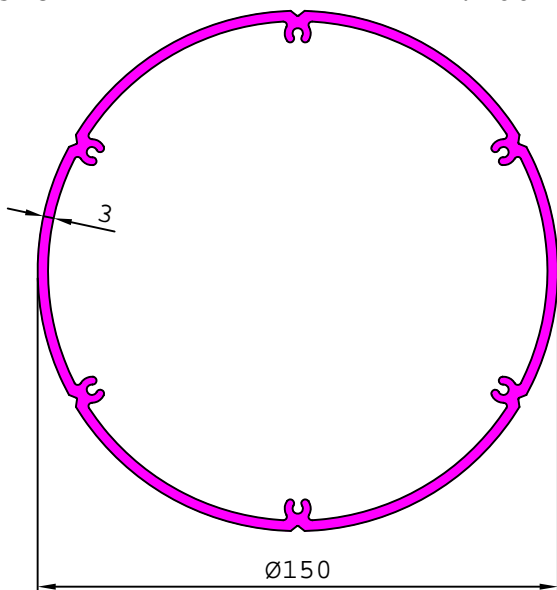

27563

6.100 kg/m

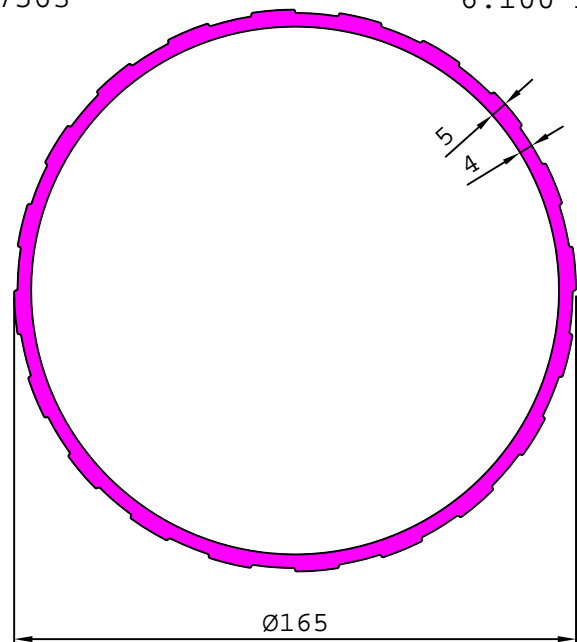

MISCELLANEOUS TUBES

27576

5.106 kg/m

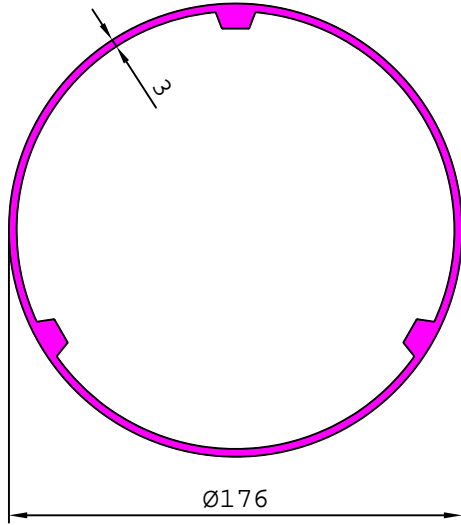

27583

3.609 kg/m

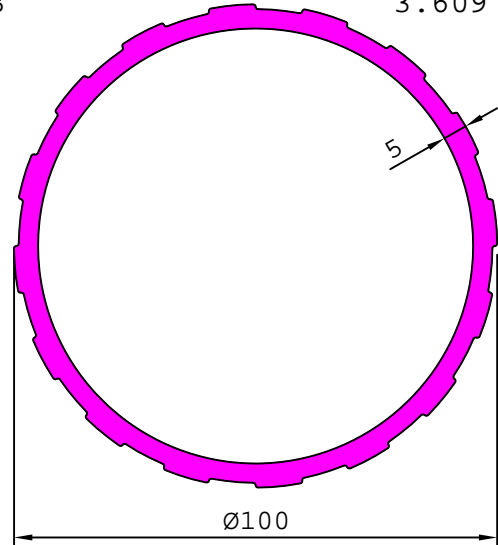

27388

1.467 kg/m

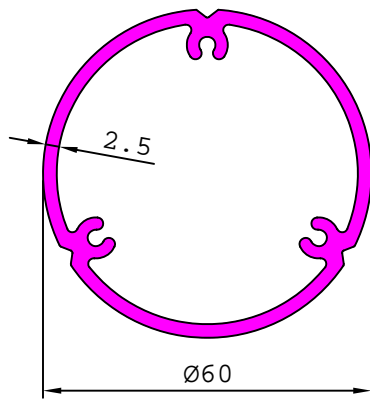

27916

4.970 kg/m

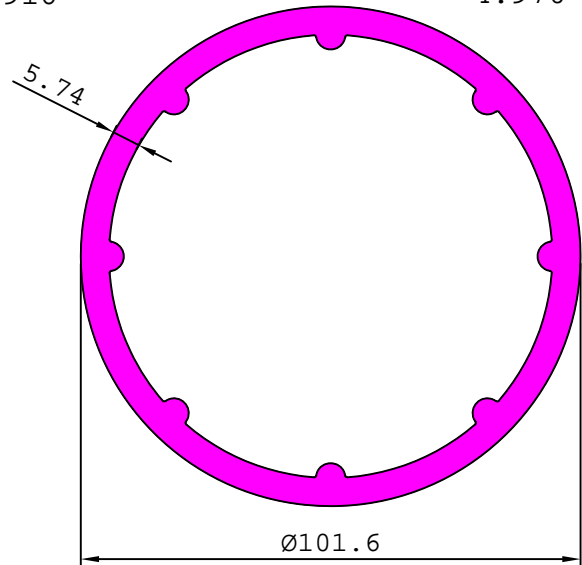

28897

2.348 kg/m

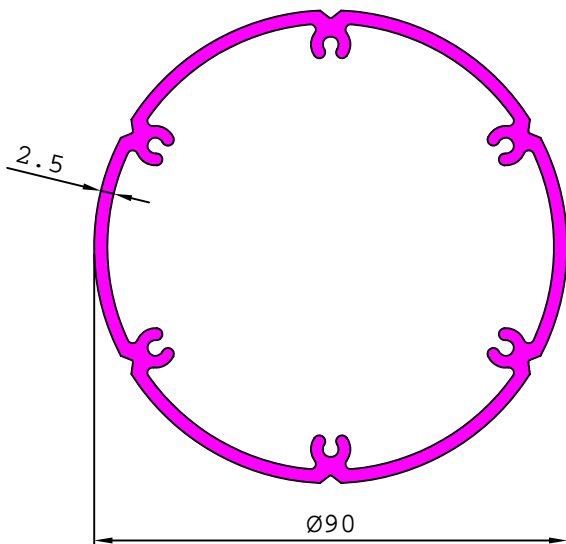

29289

3.766 kg/m

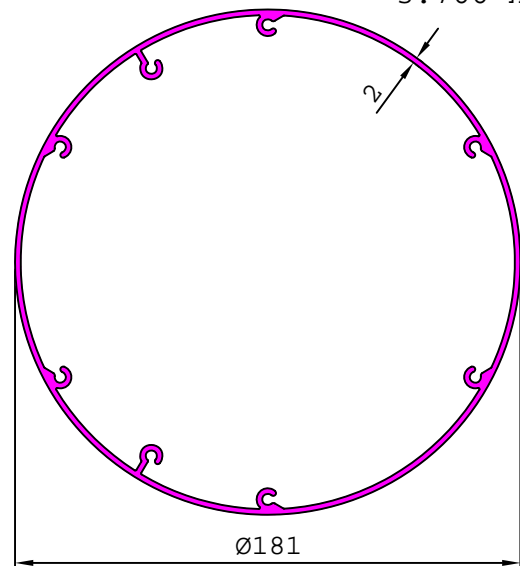

MISCELLANEOUS TUBES

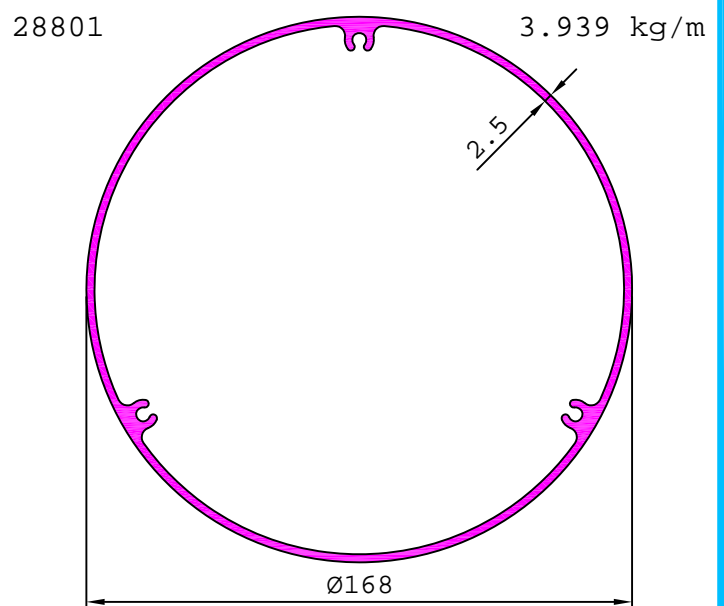
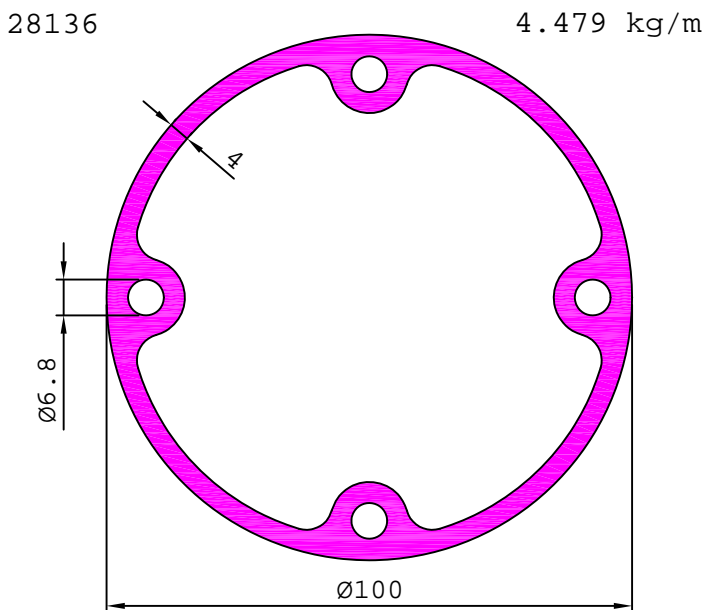
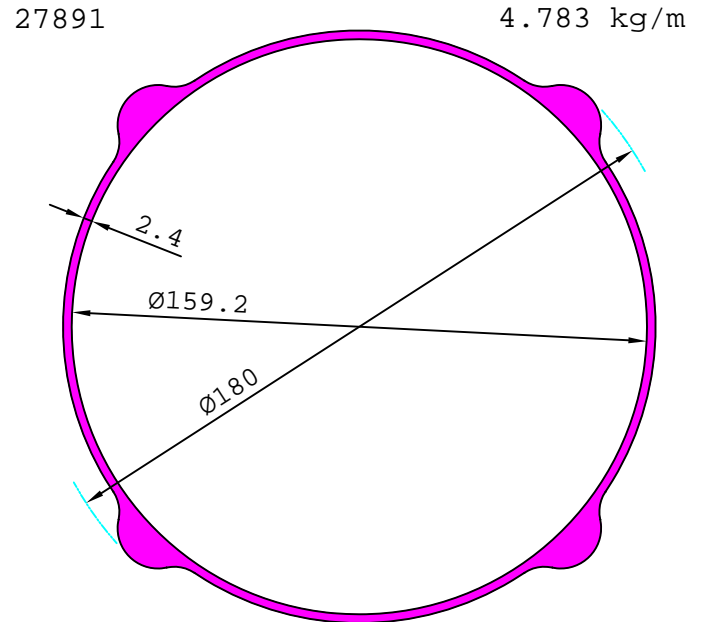
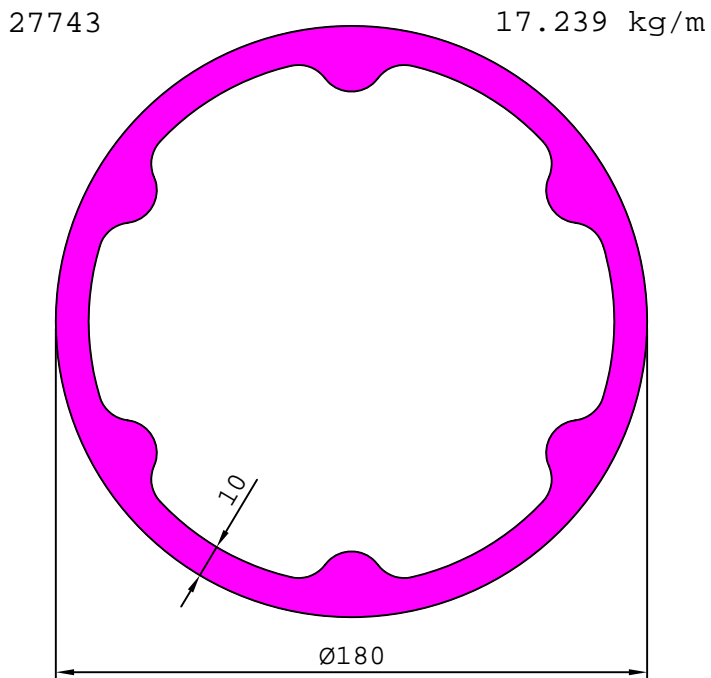
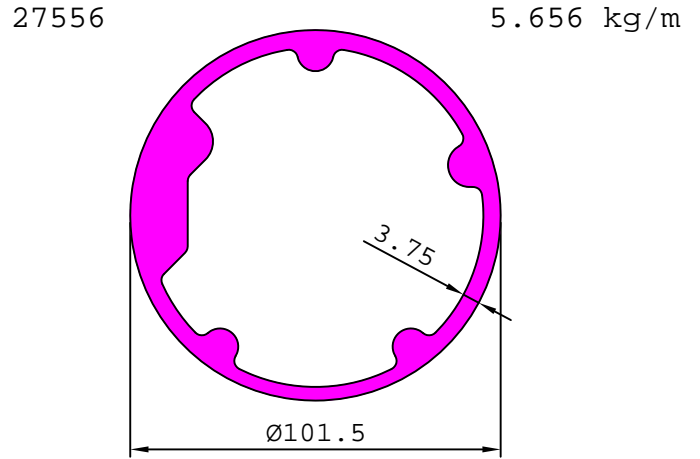
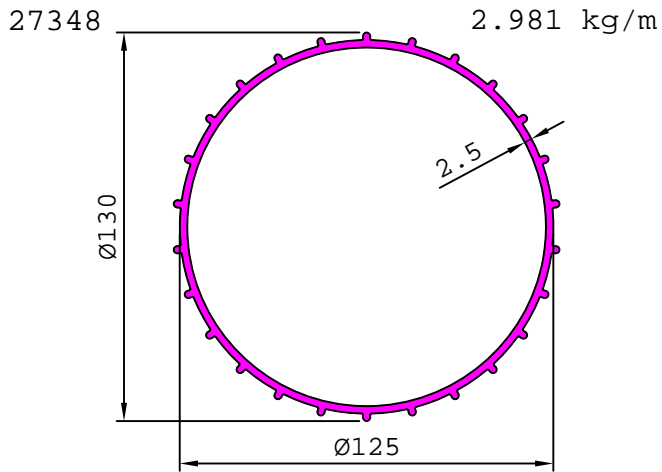

MISCELLANEOUS TUBES

28955

3.599 kg/m

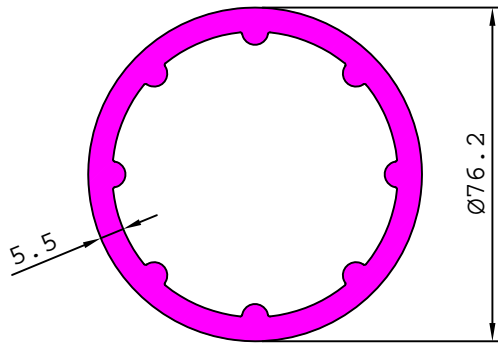

29576

2.450 kg/m

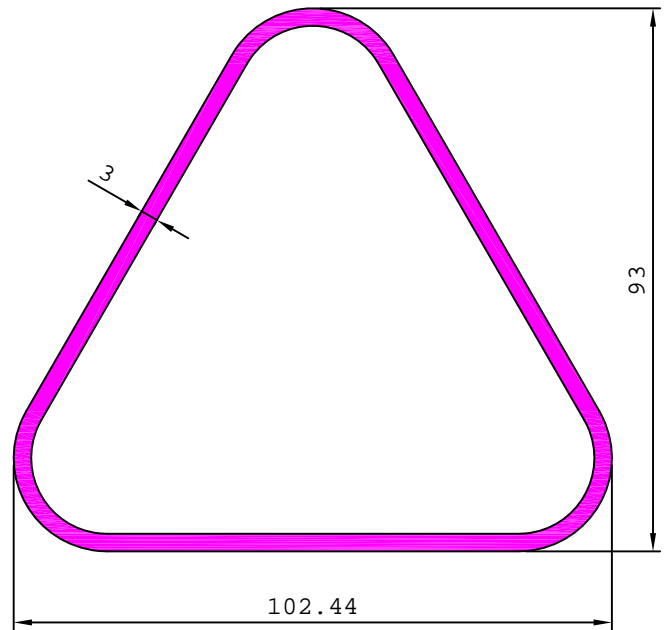

29608

1.212 kg/m

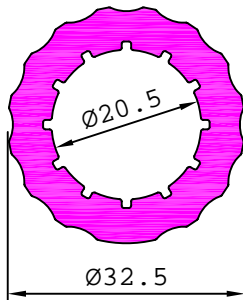

S4500

1.421 kg/m

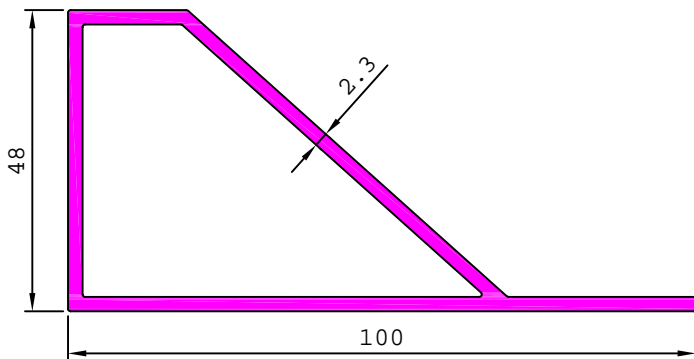

S4512

1.017 kg/m

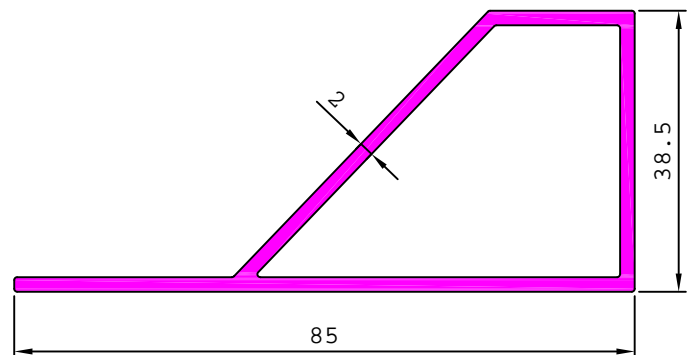

S4446

0.184 kg/m

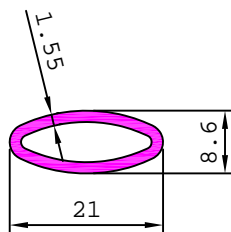

S5187

2.058 kg/m

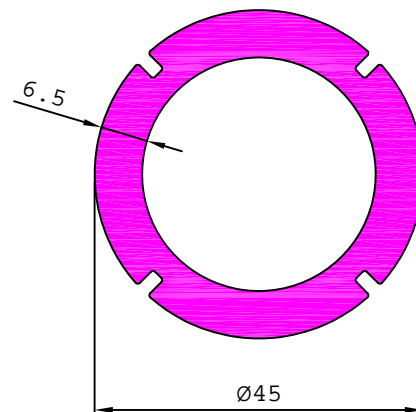

S5262

0.572 kg/m

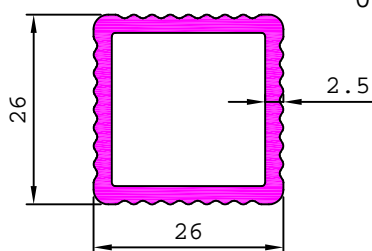

MISCELLANEOUS TUBES

15269

2.564 kg/m

