

KITCHEN CABINET

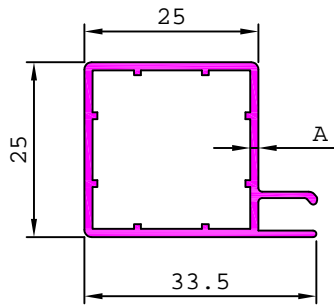

SL. No.	Section No.	A	Weight kg/m
1	22107	0.85	0.273
2	22117	1.10	0.343

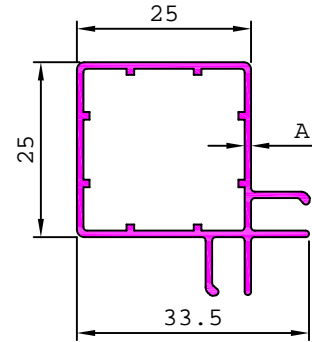

SL. No.	Section No.	A	Weight kg/m
1	22108	0.85	0.314
2	22118	1.10	0.396

22101

0.386 kg/m

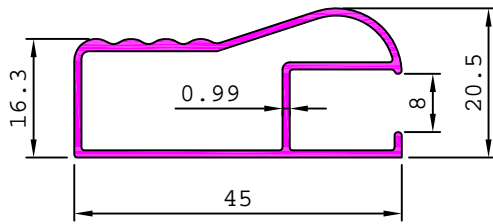

22106

0.312 kg/m

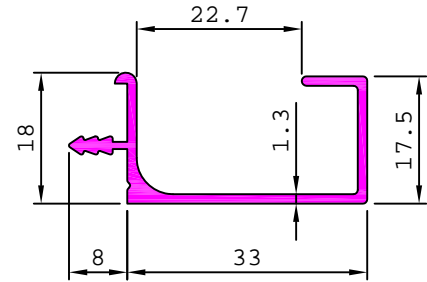

22110

0.545 kg/m

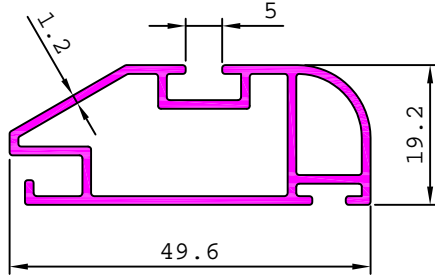

22113

0.484 kg/m

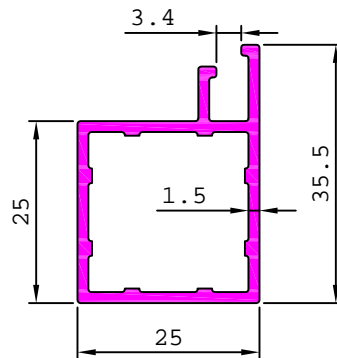

22114

0.423 kg/m

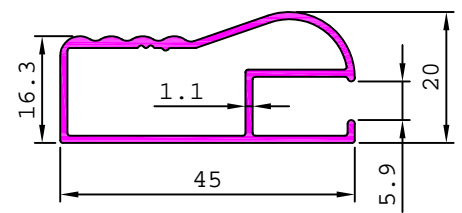

22115

0.666 kg/m

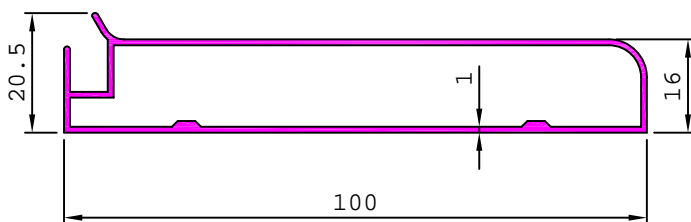

22116

0.457 kg/m

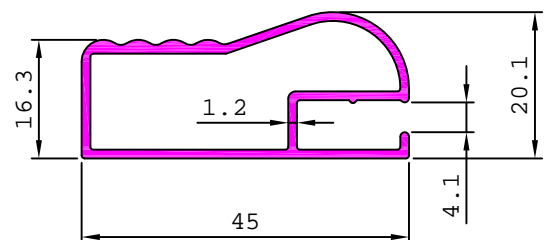

KITCHEN CABINET

22109 1.256 kg/m

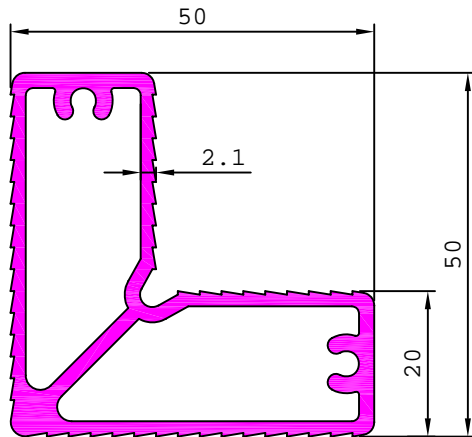

22119 0.594 kg/m

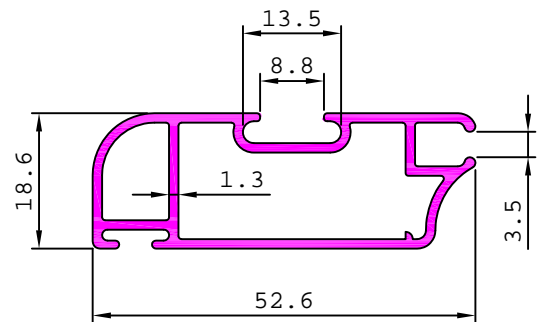

22121 0.389 kg/m

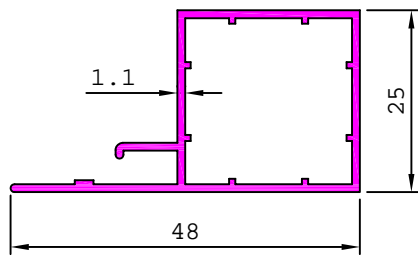

22122 0.111 kg/m

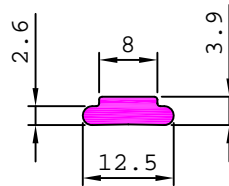

22132 0.540 kg/m

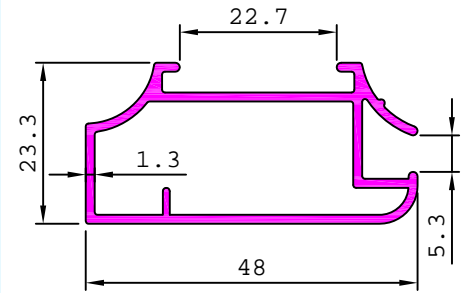

22123 0.581 kg/m

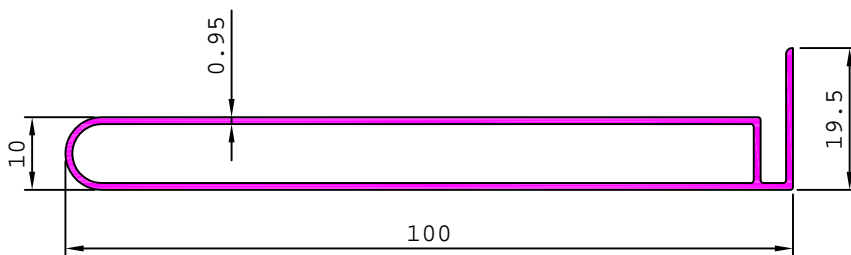

22124 0.521 kg/m

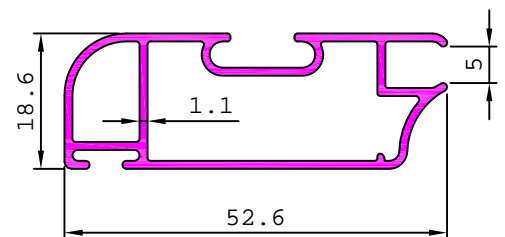

22133 0.620 kg/m

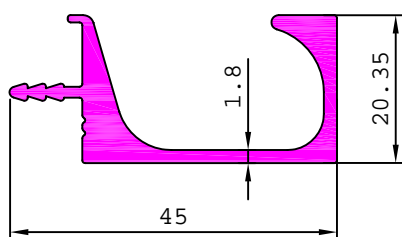

22134 0.723 kg/m

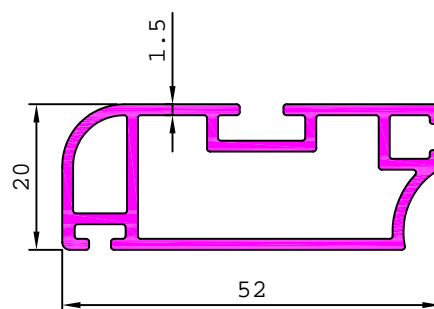

22135 0.290 kg/m

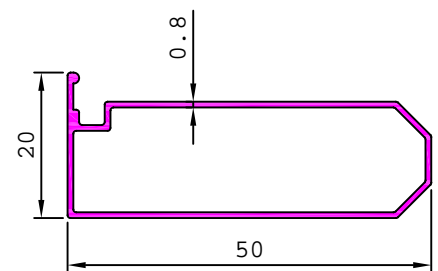

KITCHEN CABINET

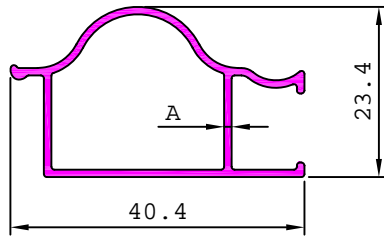

SL. No.	Section No.	A	Weight kg/m
1	15208	0.76	0.239
2	15209	1.03	0.315

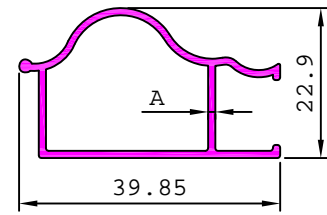

SL. No.	Section No.	A	Weight kg/m
1	15184	0.80	0.247
2	15147	0.95	0.288
3	15132	1.10	0.331

19629

0.388 kg/m

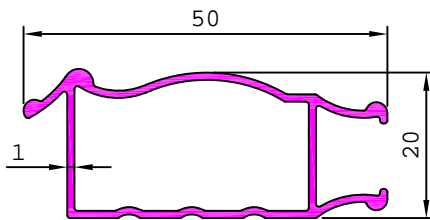

35044

0.225 kg/m

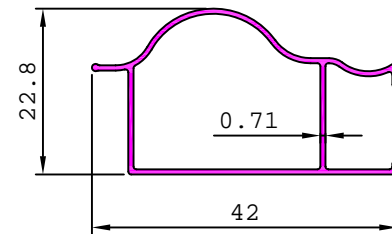

22136

0.194 kg/m

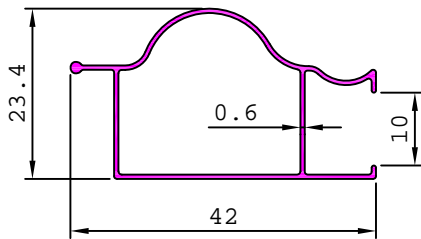

22137

0.224 kg/m

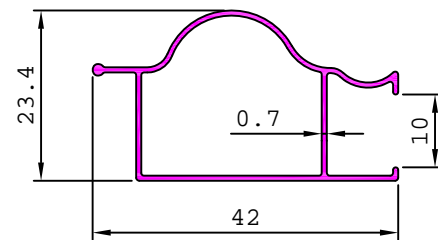

22138

0.268 kg/m

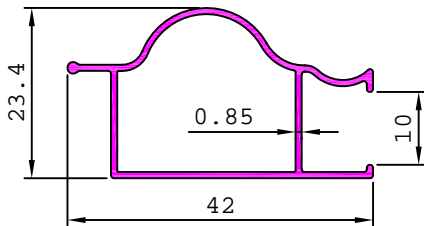

22139

0.303 kg/m

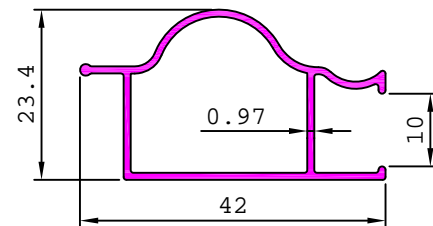

22140

0.277 kg/m

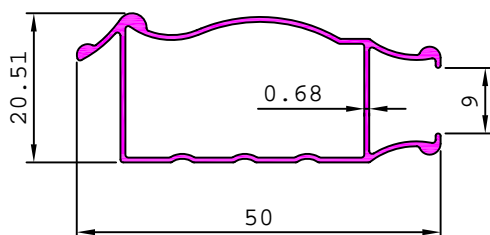

22141

0.284 kg/m

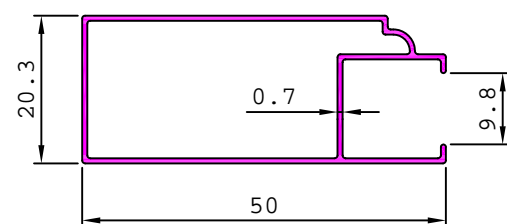

KITCHEN CABINET

22142

0.202 kg/m

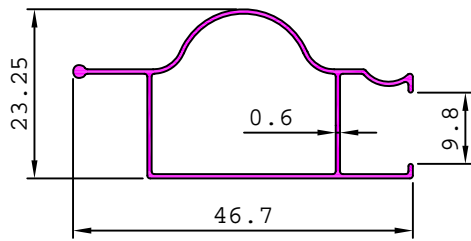

22143

0.358 kg/m

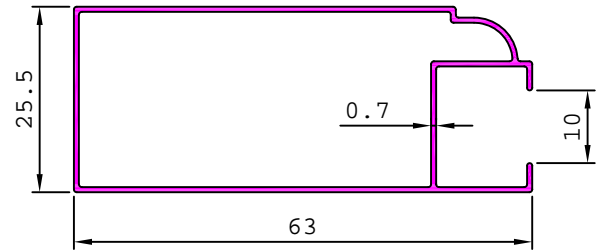

22144

0.296 kg/m

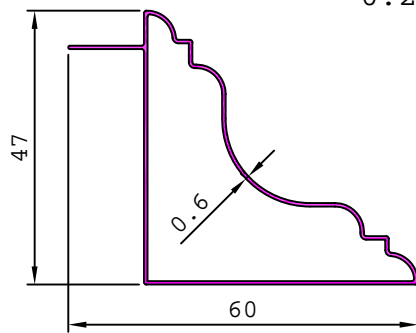

22145

0.256 kg/m

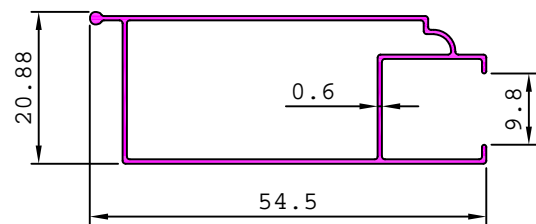

22146

0.274 kg/m

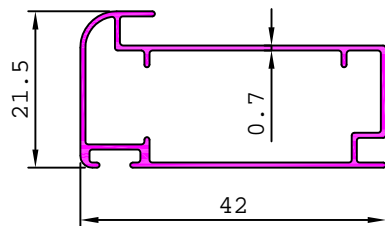

22149

0.288 kg/m

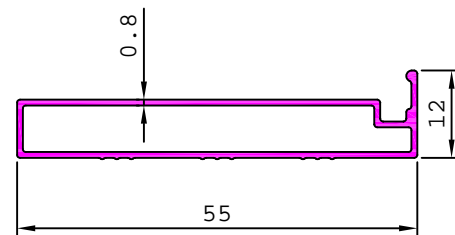

22147

0.159 kg/m

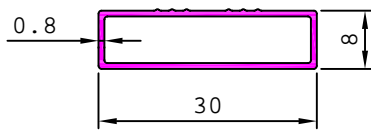

22148

0.228 kg/m

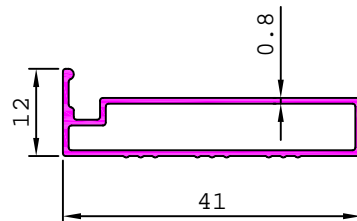

22150

0.093 kg/m

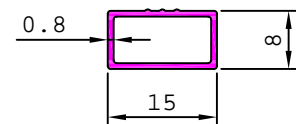

22151

0.340 kg/m

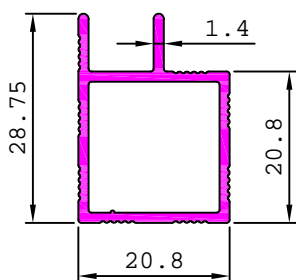

22152

0.413 kg/m

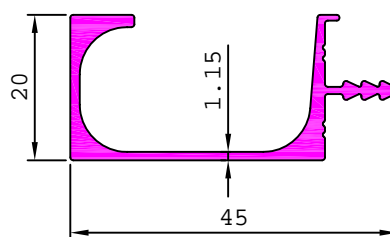

22154

0.343 kg/m

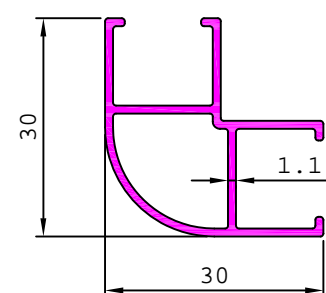

KITCHEN CABINET

22153

0.370 kg/m

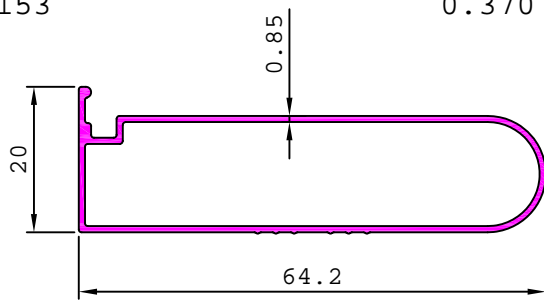

22155

0.711 kg/m

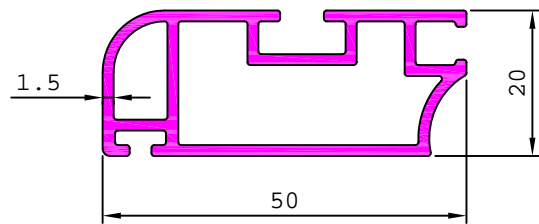

15211

0.250 kg/m

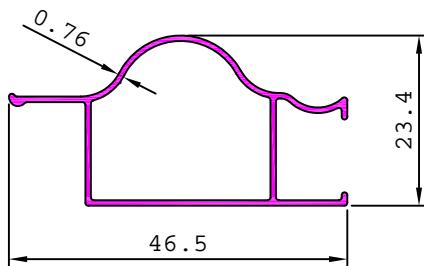

29394

0.491 kg/m

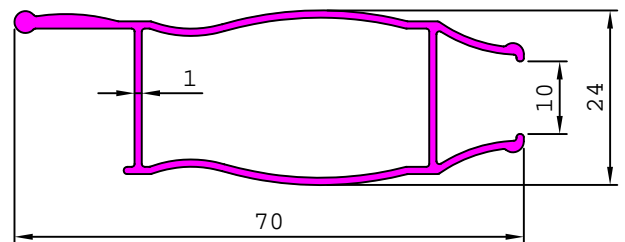

28868

0.301 kg/m

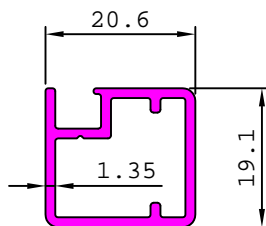

15262

0.330 kg/m

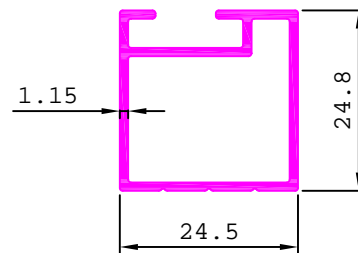

S4948

0.583 kg/m

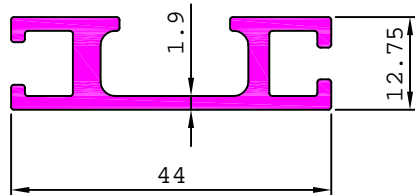

22156

0.278 kg/m

