

DISPLAY SECTION

20352 0.238 kg/m

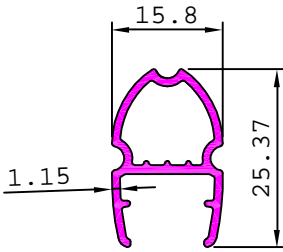

20353 0.870 kg/m

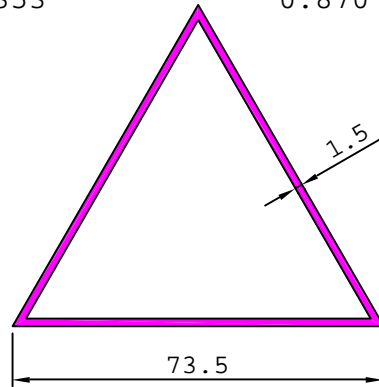

20354 0.230 kg/m

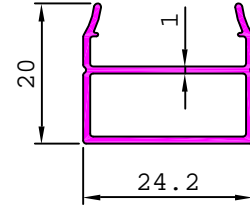

20356 0.864 kg/m

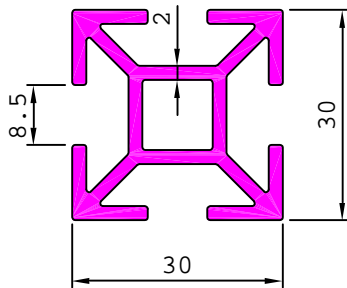

20358 0.686 kg/m

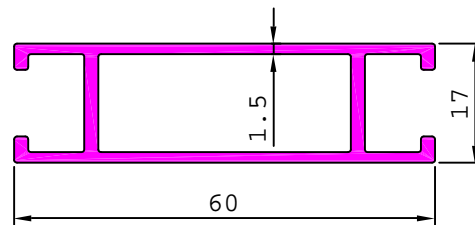

20359 1.124 kg/m

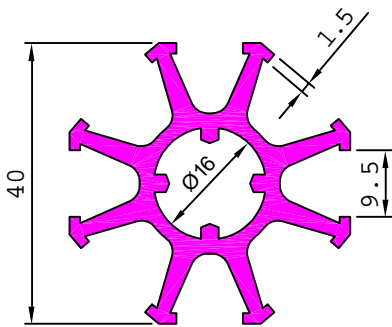

20361 0.711 kg/m

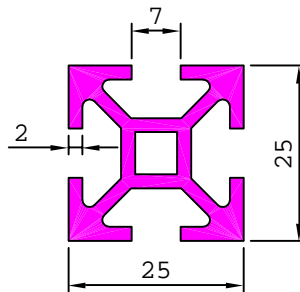

20365 0.957 kg/m

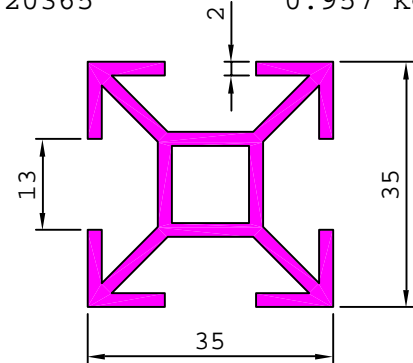

20362 1.153 kg/m

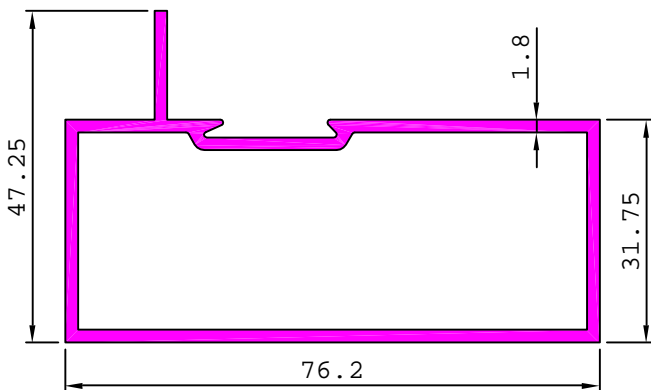

20363 1.297 kg/m

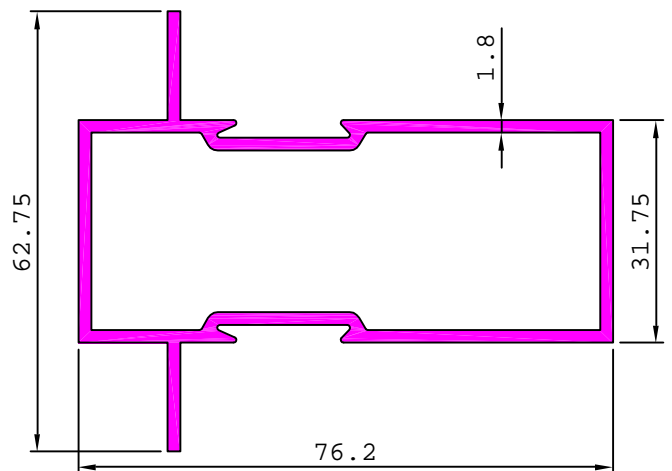

DISPLAY SECTION

<p>20366 1.531 kg/m</p>	<p>20367 0.582 kg/m</p>	<p>20368 1.058 kg/m</p>
<p>20369 1.191 kg/m</p>	<p>20370 0.702 kg/m</p>	<p>20371 1.259 kg/m</p>
<p>20372 1.042 kg/m</p>	<p>20373 0.817 kg/m</p>	<p>20374 0.676 kg/m</p>
<p>20375 1.234 kg/m</p>	<p>20376 0.199 kg/m</p>	<p>20379 0.286 kg/m</p>

DISPLAY SECTION

20380

1.567 kg/m

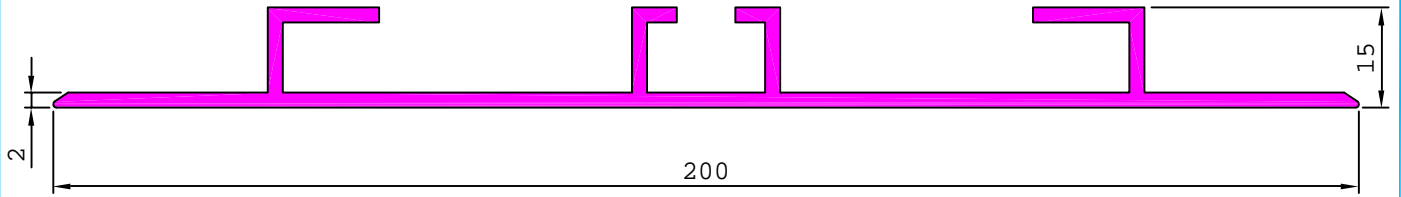

20381

0.238 kg/m

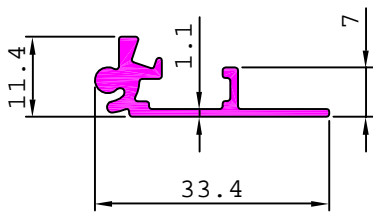

20382

0.196 kg/m

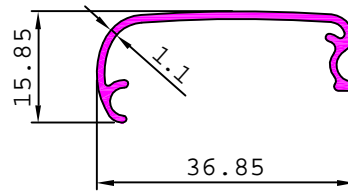

20383

1.188 kg/m

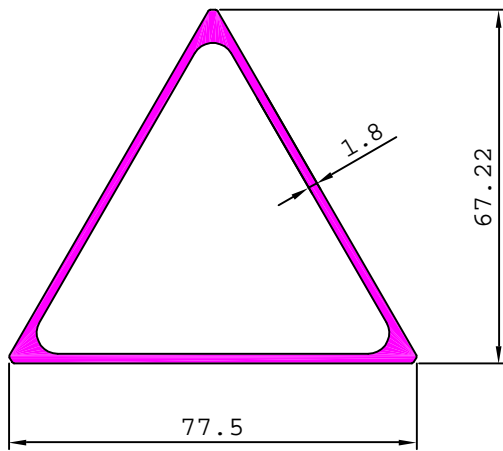

20385

0.319 kg/m

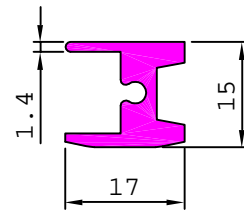

20386

0.459 kg/m

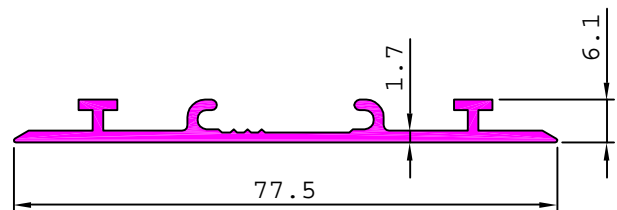

20389

2.273 kg/m

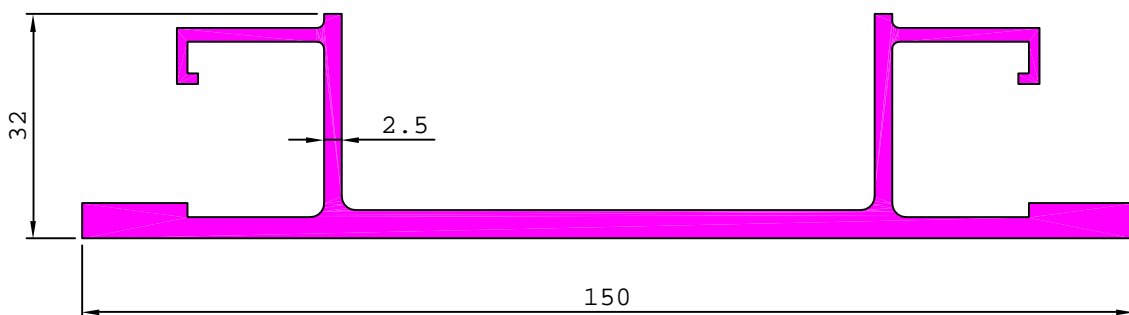

DISPLAY SECTION

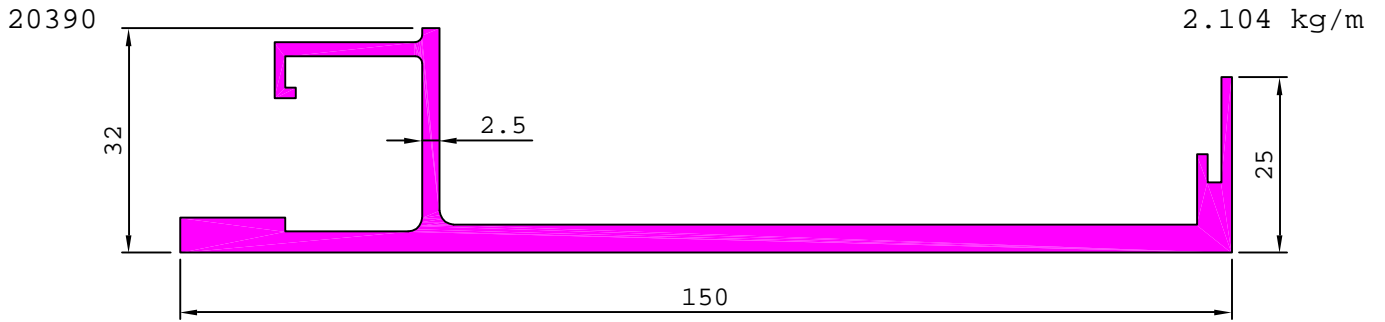

20391 0.278 kg/m

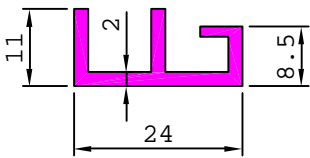

20392

1.023 kg/m

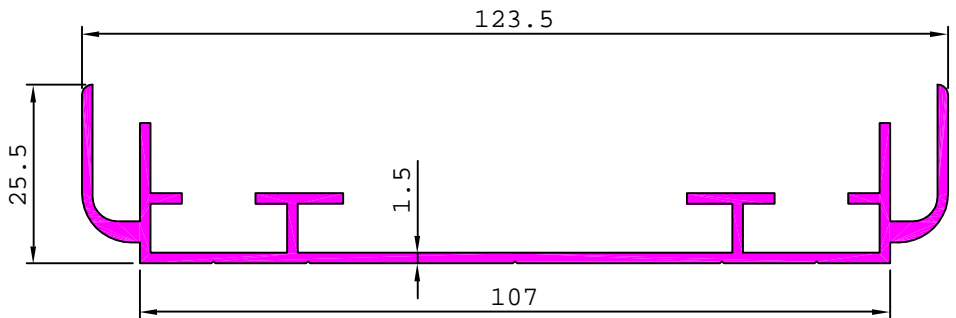

20393

1.738 kg/m

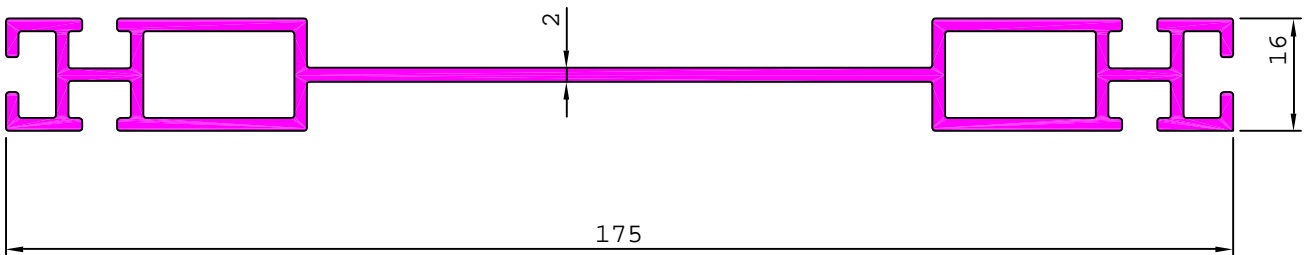

20395 0.093 kg/m

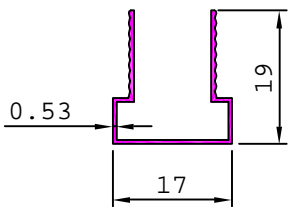

20396 0.204 kg/m

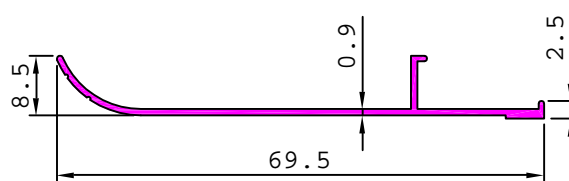

20397 0.080 kg/m

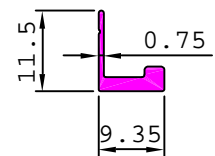

20398 0.093 kg/m

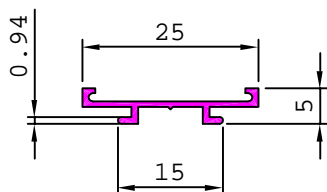

20399 0.391 kg/m

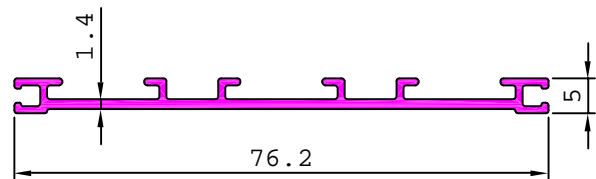

DISPLAY SECTION

20400

0.515 kg/m

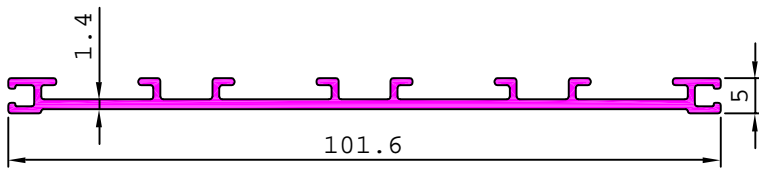

20405

0.209 kg/m

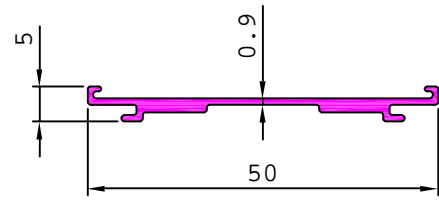

20408

0.267 kg/m

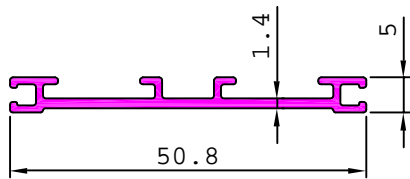

20411

0.145 kg/m

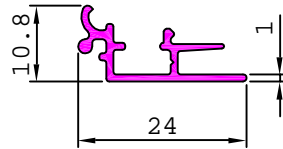

20412

0.113 kg/m

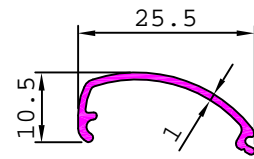

20409

0.763 kg/m

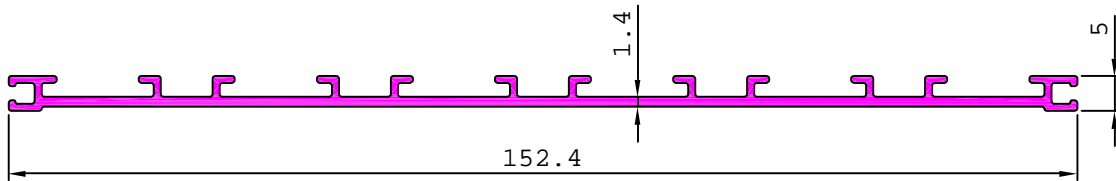

20414

0.714 kg/m

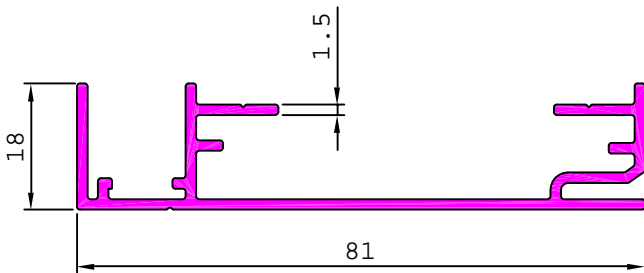

20416

0.313 kg/m

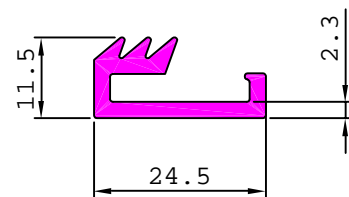

20415

0.774 kg/m

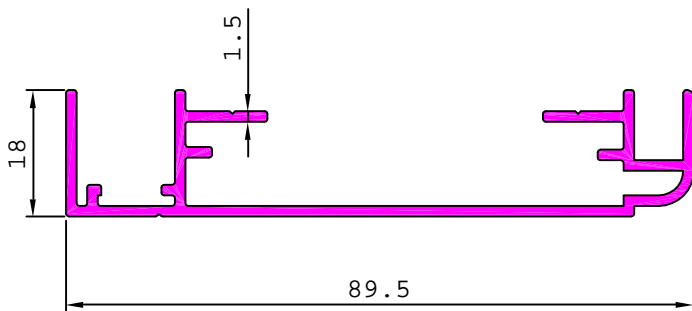

20417

0.644 kg/m

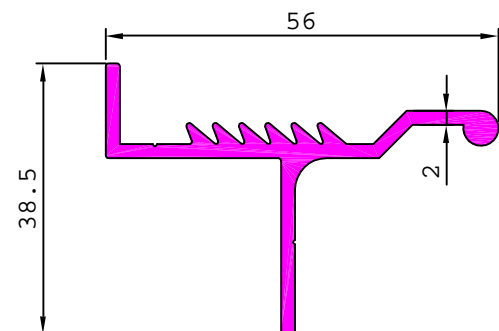

DISPLAY SECTION

20418 1.359 kg/m

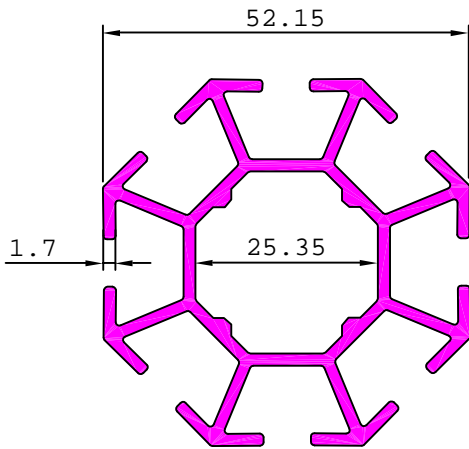

20424 0.212 kg/m

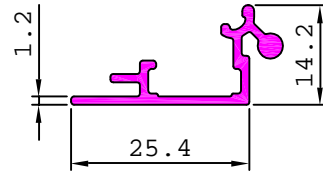

20425 0.213 kg/m

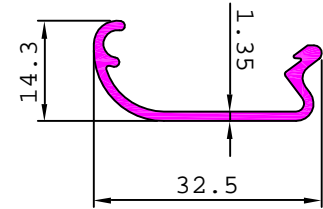

20420 1.152 kg/m

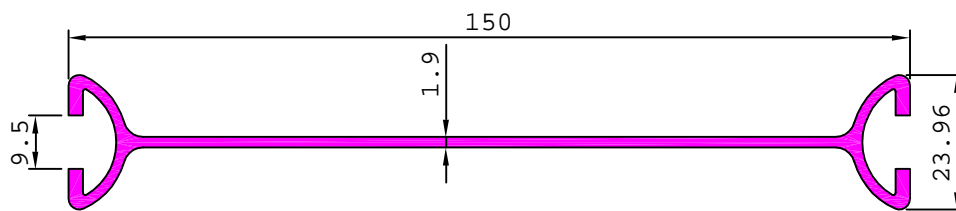

20419 0.054 kg/m

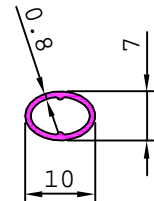

20423 1.907 kg/m

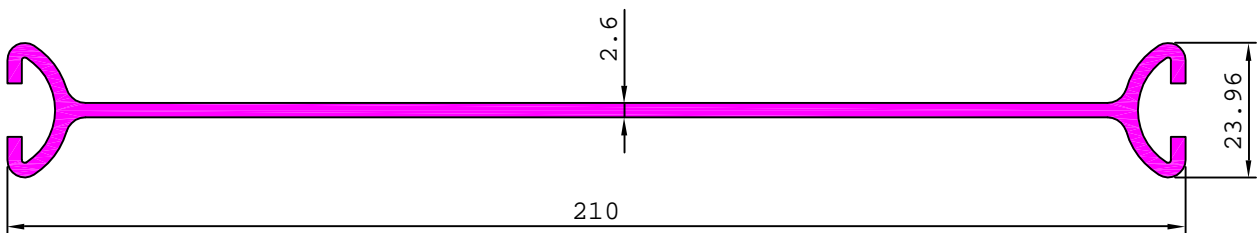

20426 0.924 kg/m

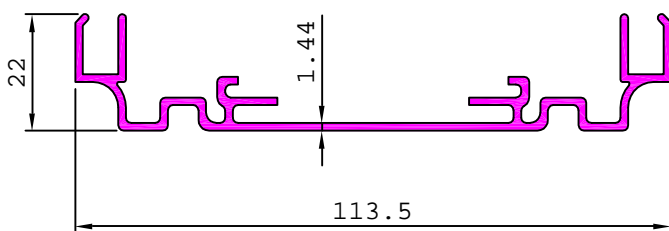

20427 0.503 kg/m

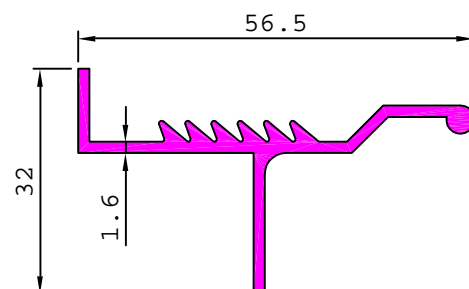

DISPLAY SECTION

20430 0.733 kg/m

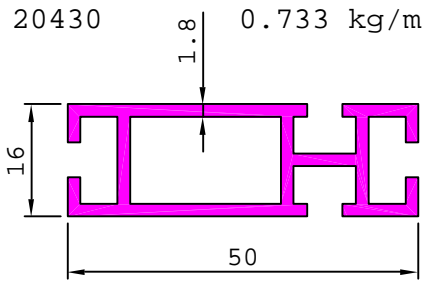

20431 0.479 kg/m

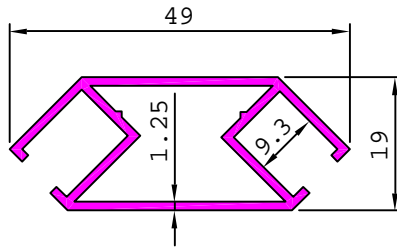

20436 0.324 kg/m

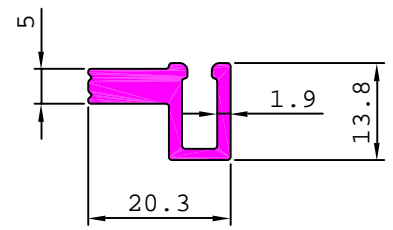

20432 1.278 kg/m

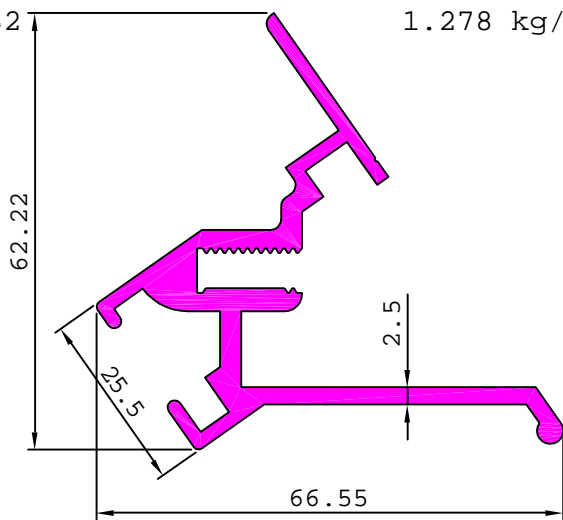

20437 1.262 kg/m

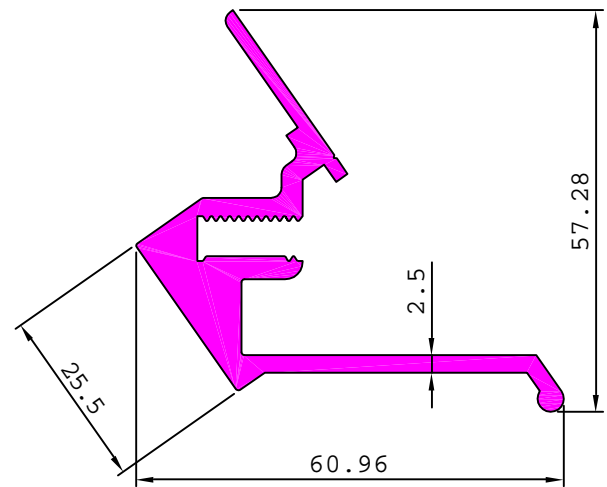

20439 0.829 kg/m

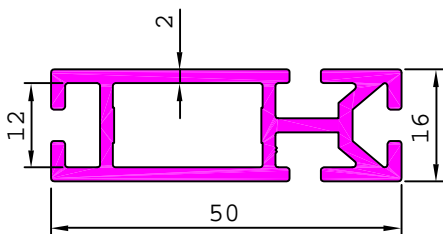

20440 0.838 kg/m

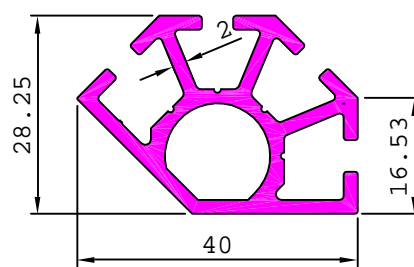

20441 0.272 kg/m

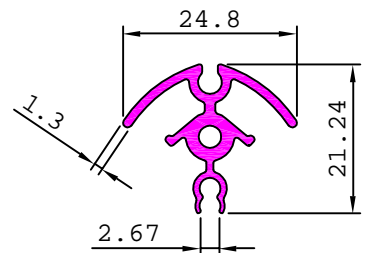

20442 1.425 kg/m

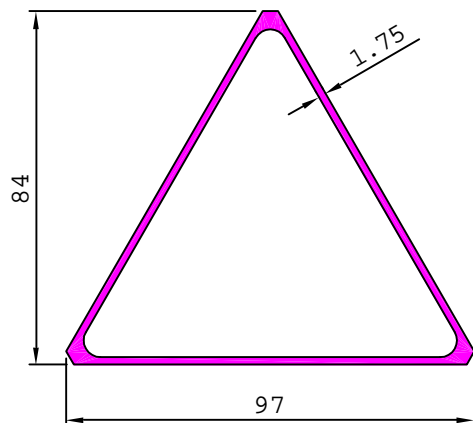

20443 0.564 kg/m

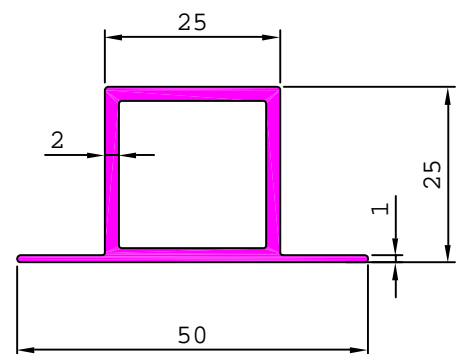

SUPER PROFILE

DISPLAY SECTION

20444

0.590 kg/m

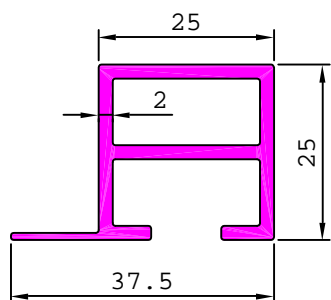

20445

0.611 kg/m

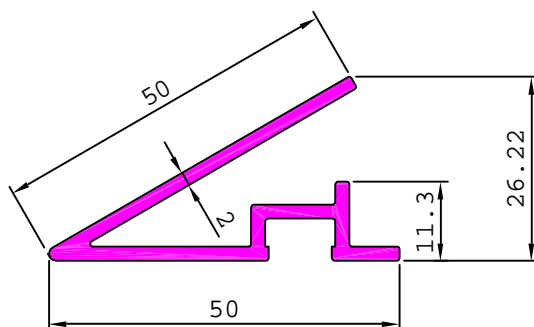

20446

0.706 kg/m

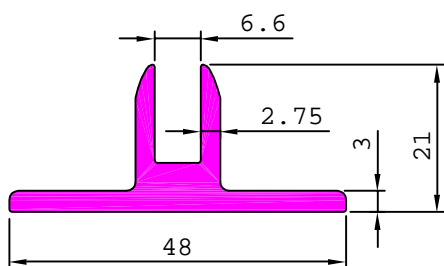

20448

0.735 kg/m

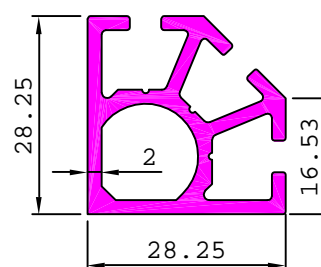

20447

0.473 kg/m

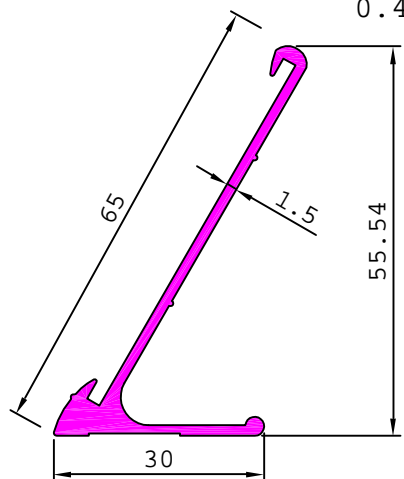

20449

0.954 kg/m

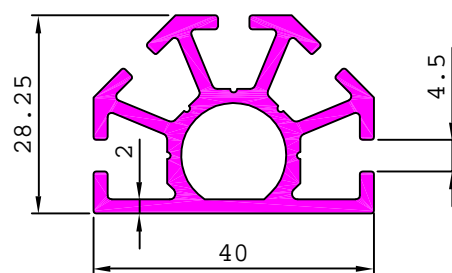

20450

1.212 kg/m

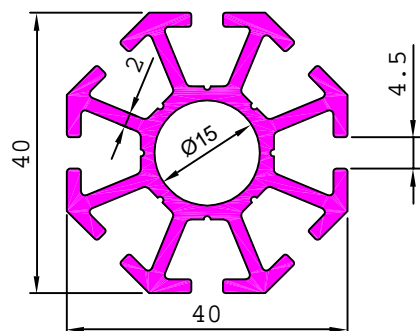

20451

0.640 kg/m

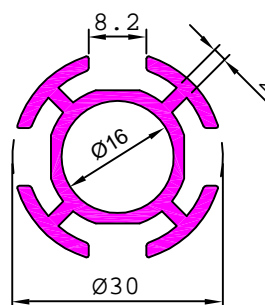

SUPER PROFILE

DISPLAY SECTION

20452 0.273 kg/m

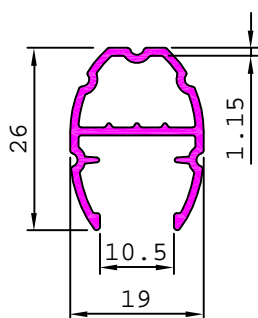

20453 0.658 kg/m

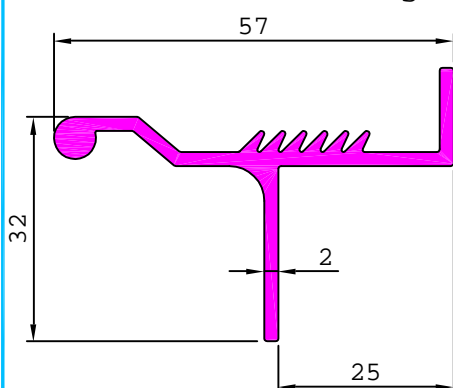

20454 0.687 kg/m

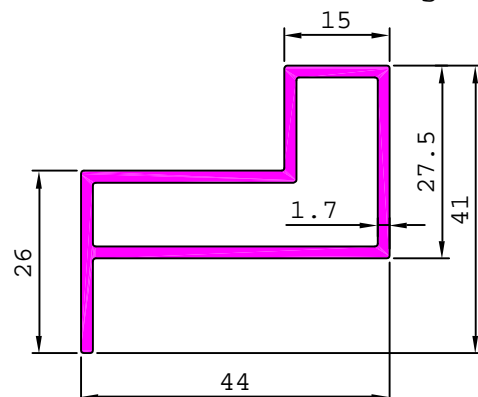

20455 0.544 kg/m

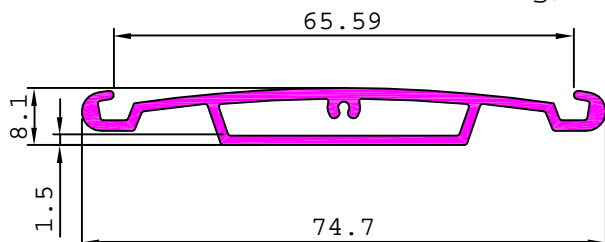

20456 0.846 kg/m

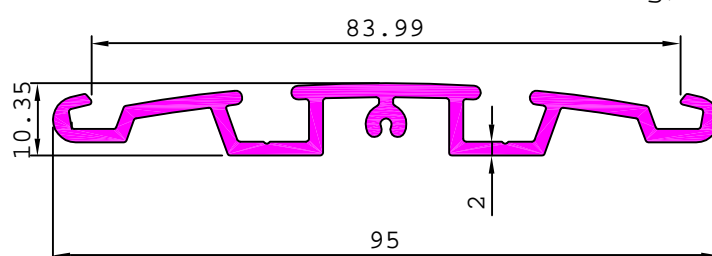

20457

1.503 kg/m

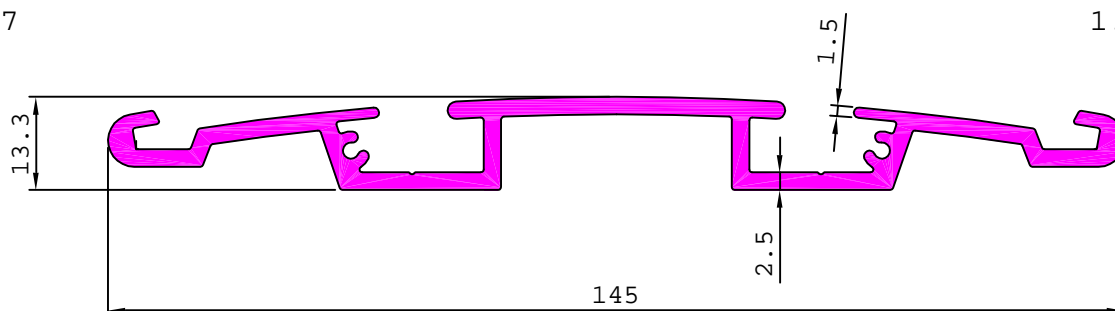

20458

2.154 kg/m

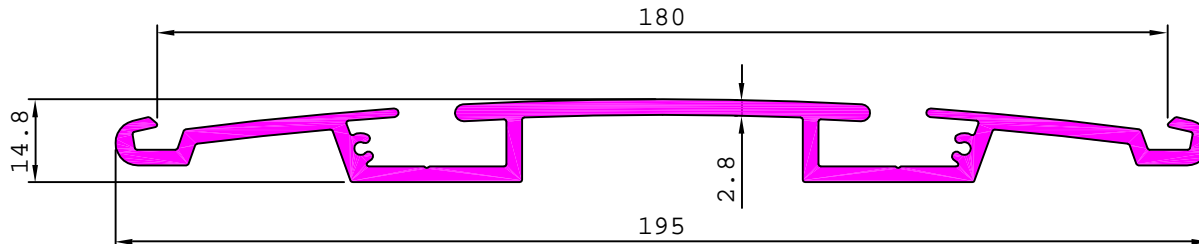

20459 0.345 kg/m

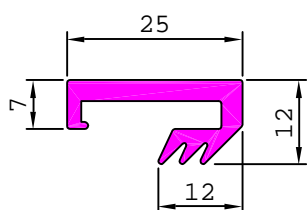

20460 0.669 kg/m

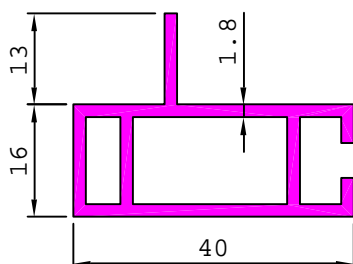

20461 56.2 0.483 kg/m

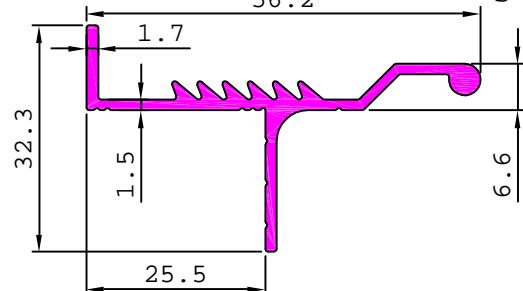

DISPLAY SECTION

20462 0.217 kg/m

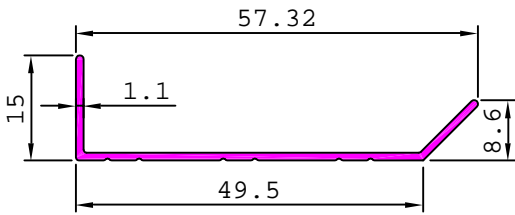

20465 0.336 kg/m

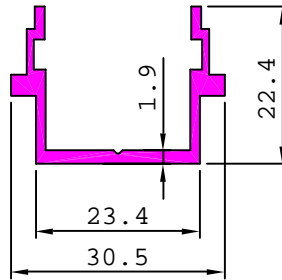

20466 0.837 kg/m

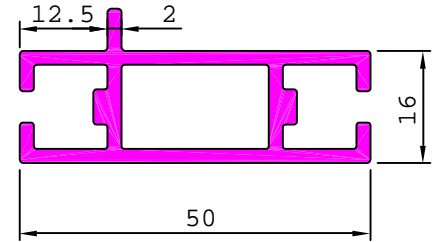

20463

1.968 kg/m

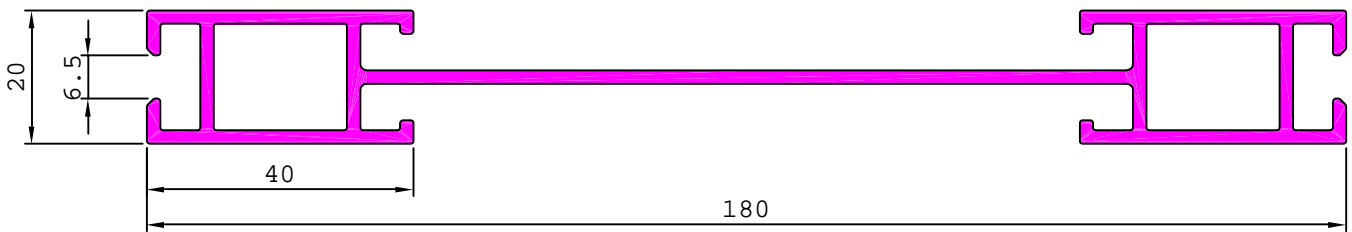

20464

1.765 kg/m

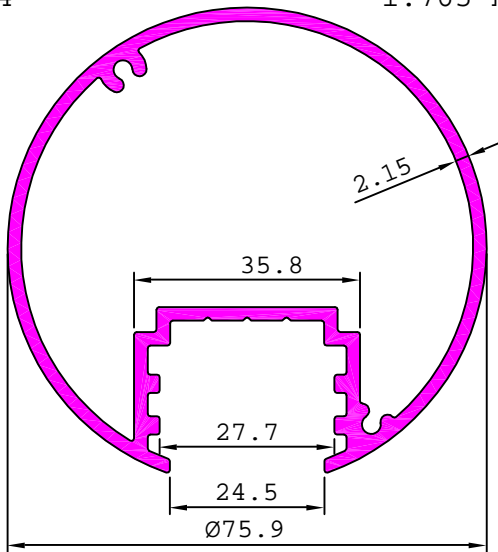

20467

0.319 kg/m

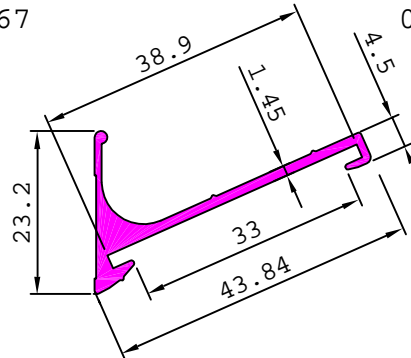

20468

0.584 kg/m

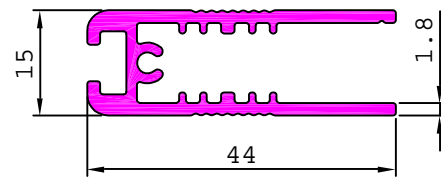

20469 0.667 kg/m

20470

1.931 kg/m

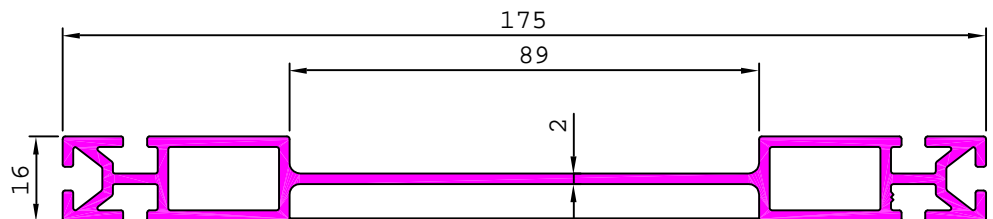
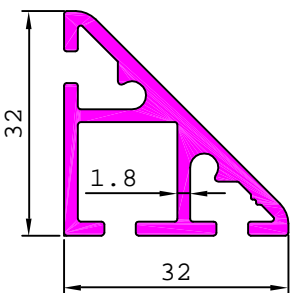

SUPER PROFILE

DISPLAY SECTION

20471 0.805 kg/m

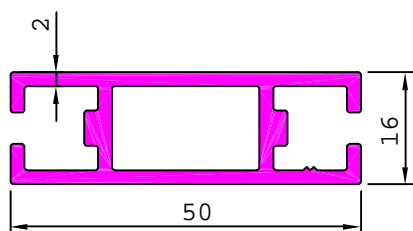

20473 1.554 kg/m

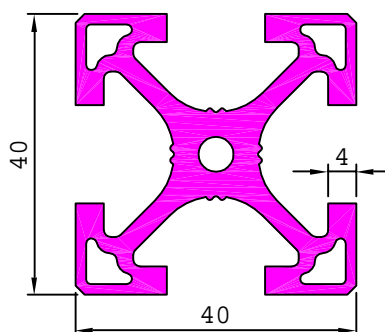

20474 0.747 kg/m

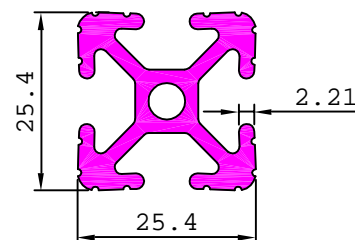

20472 3.797 kg/m

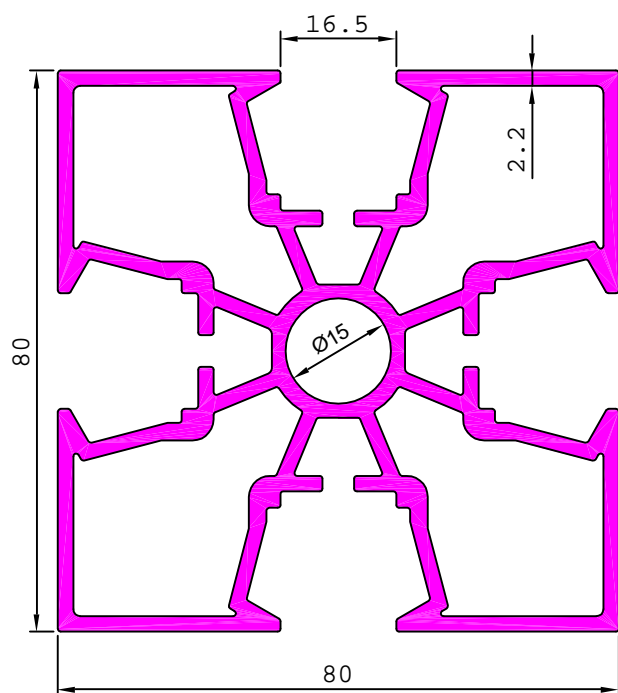

20475 0.157 kg/m

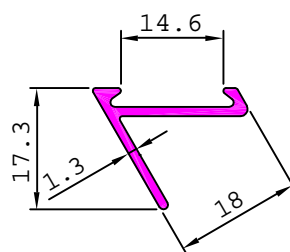

20476 0.232 kg/m

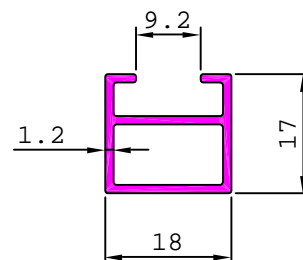

20477 0.420 kg/m

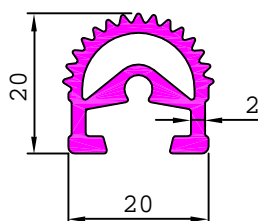

20478

2.484 kg/m

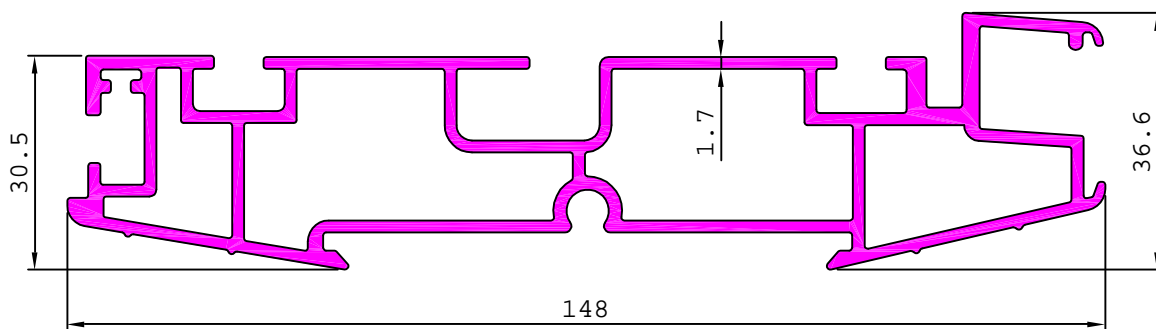

SUPER PROFILE

DISPLAY SECTION

20479

2.089 kg/m

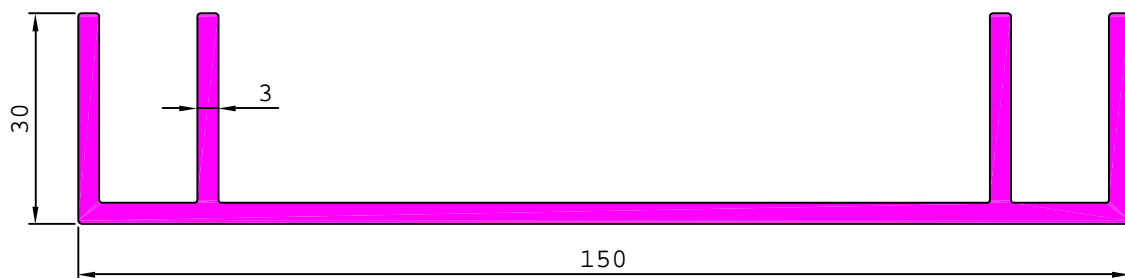

20480

9.581 kg/m

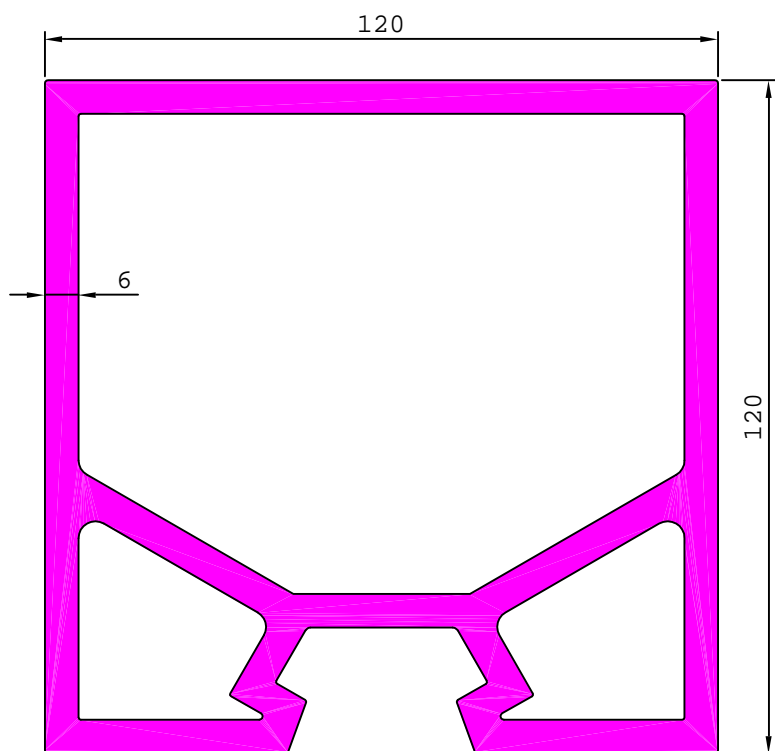

20481

0.400 kg/m

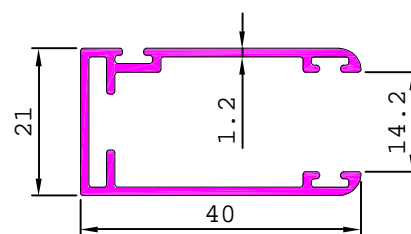

20482

0.695 kg/m

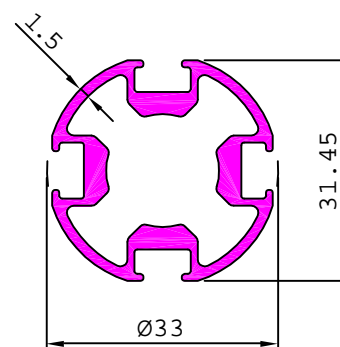

20483

1.585 kg/m

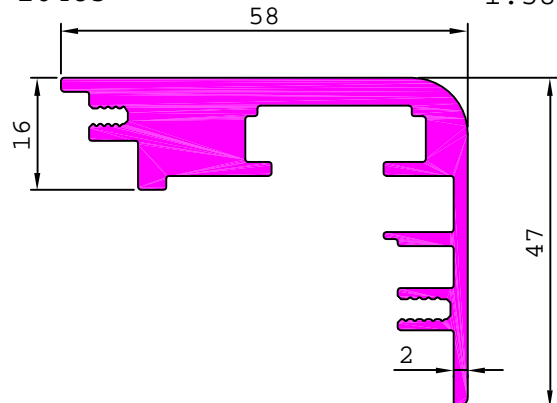

20484

0.823 kg/m

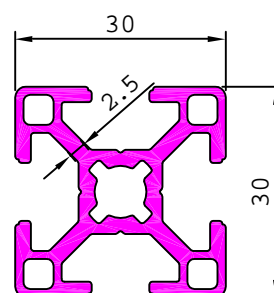

DISPLAY SECTION

20485 1.534 kg/m

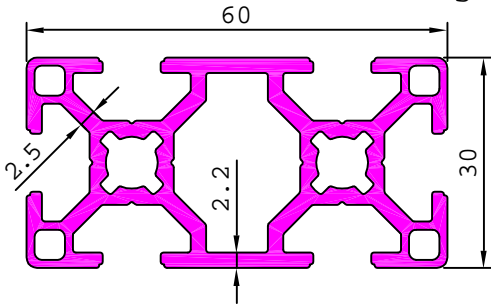

20486 0.489 kg/m

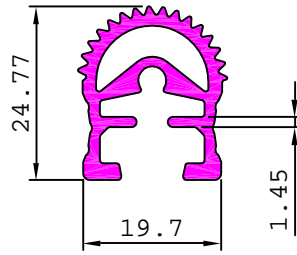

20487 0.186 kg/m

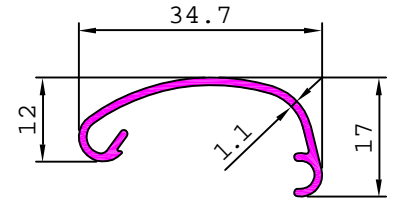

20488 0.224 kg/m

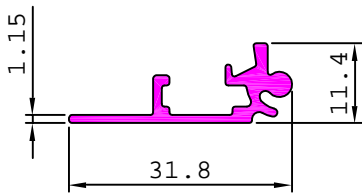

S1872 0.366 kg/m

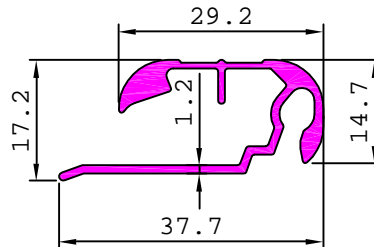

S1921 2.059 kg/m

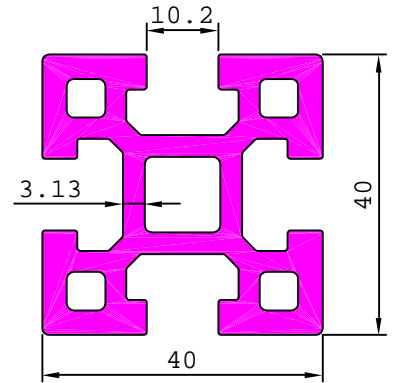

S1919 0.574 kg/m

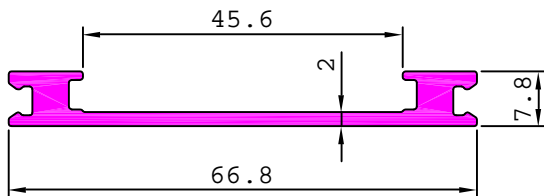

S1920 3.794 kg/m

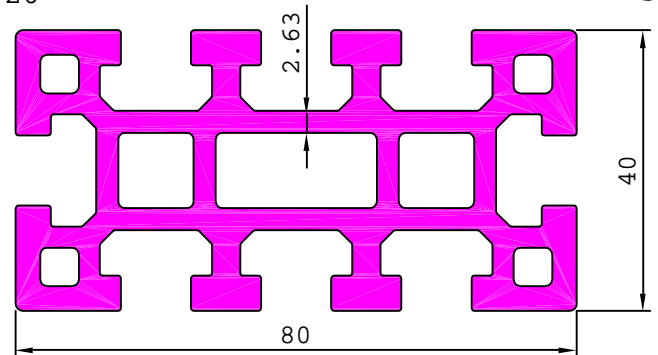

S1909 0.872 kg/m

