

## DETAILS OF SLIDING WINDOW SECTIONS

### SERIES - A 15 mm.

### PART I - S/W 1/2"

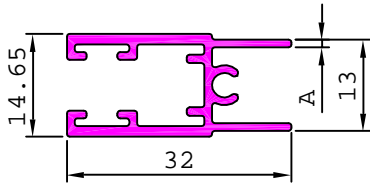

SL. No.	Section No.	A	Weight kg/m
1	20969	0.80	0.233
2	20945	0.90	0.263
3	20581	1.10	0.344

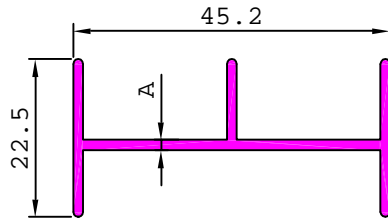

SL. No.	Section No.	A	Weight kg/m
1	20582	1.50	0.378
2	20946	0.89	0.238

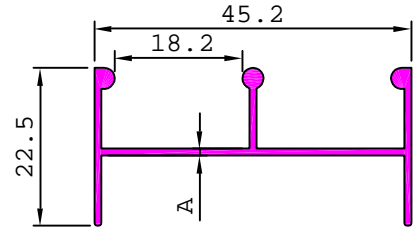

SL. No.	Section No.	A	Weight kg/m
1	20624	1.20	0.353
2	20961	1.00	0.304

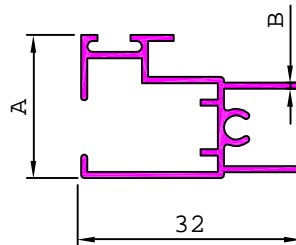
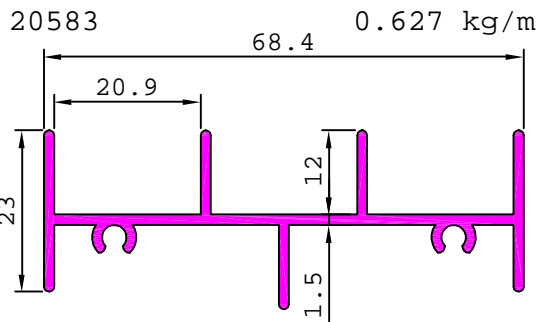

SL. No.	Section No.	A	B	Weight kg/m
1	20868	20.50	0.70	0.220
2	20947	20.75	0.82	0.257
3	20584	20.75	1.10	0.335

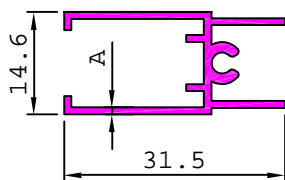

SL. No.	Section No.	A	Weight kg/m
1	20870	0.74	0.190
2	20718	1.00	0.263

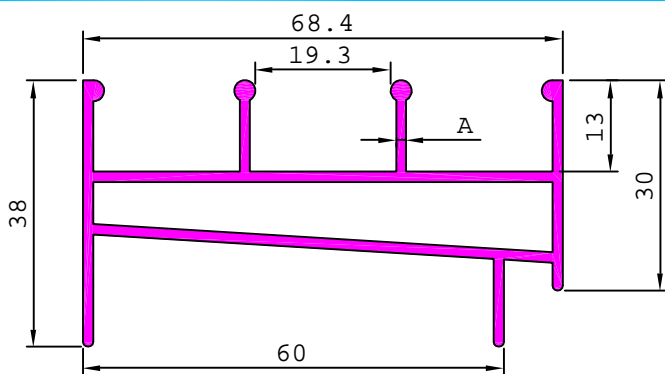
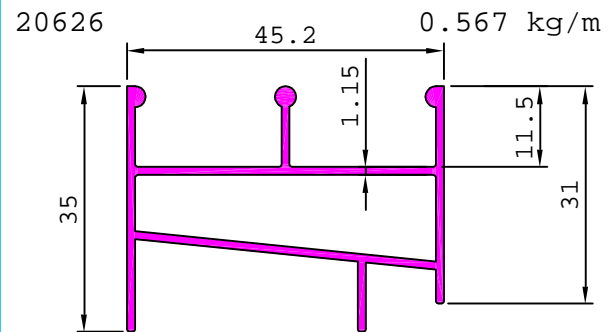

SL. No.	Section No.	A	Weight kg/m
1	20955	1.13	0.759
2	20618	1.50	0.980

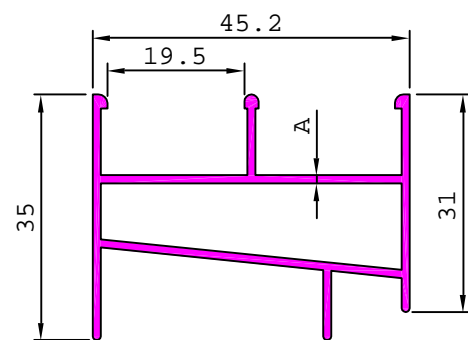

SL. No.	Section No.	A	Weight kg/m
1	20954	1.07	0.496
2	20616	1.15	0.546

## DETAILS OF SLIDING WINDOW SECTIONS

### SERIES - A 15 mm.

#### PART I - S/W 1/2"

20625

0.488 kg/m

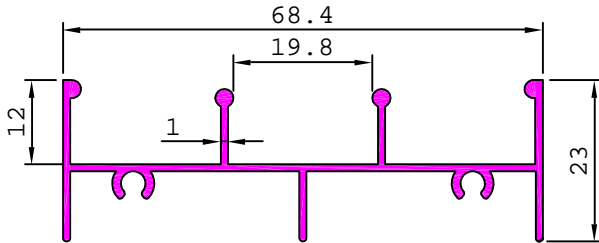

20951

0.297 kg/m

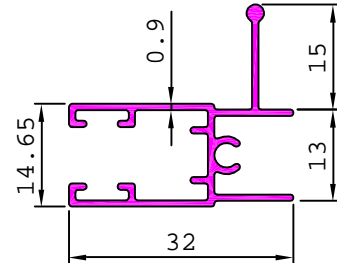

#### PART II - S/W 5/8"

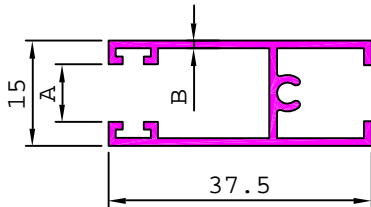

SL. No.	Section No.	A	B	Weight kg/m
1	20809	8.20	1.08	0.329
2	20597	7.80	1.60	0.485

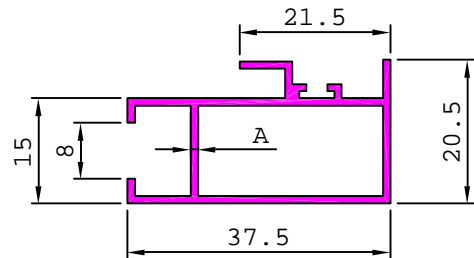

SL. No.	Section No.	A	Weight kg/m
1	20810	1.07	0.369
2	20655	1.50	0.482

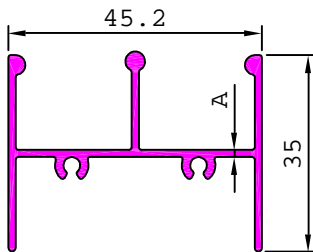

SL. No.	Section No.	A	Weight kg/m
1	20808	0.98	0.414
2	20664	1.30	0.551

20668

0.377 kg/m

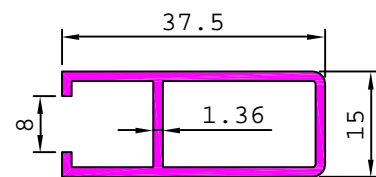

20671

0.699 kg/m

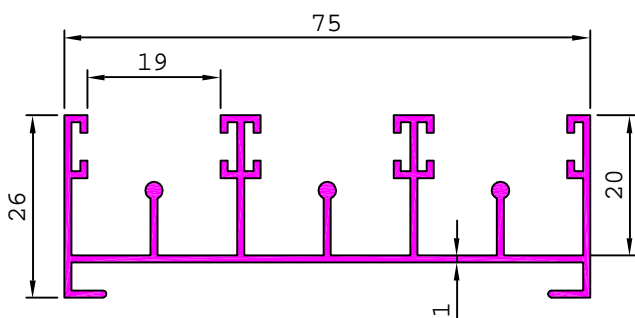

20672

0.594 kg/m

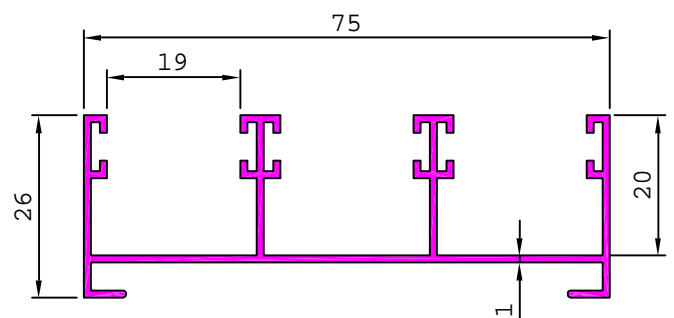

## DETAILS OF SLIDING WINDOW SECTIONS

### SERIES - A 15 mm.

### PART II - S/W 5/8"

20669 0.548 kg/m

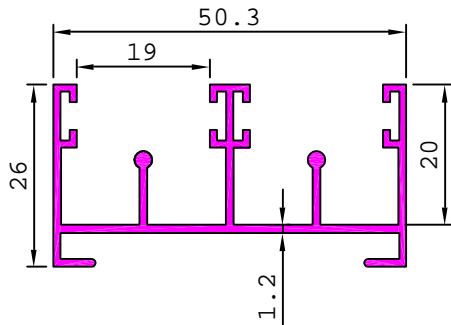

20670 0.432 kg/m

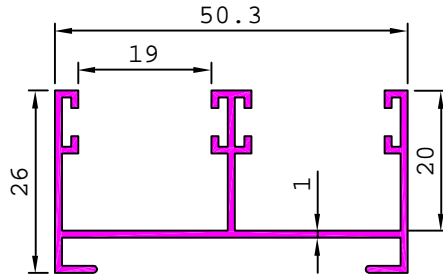

20689 0.481 kg/m

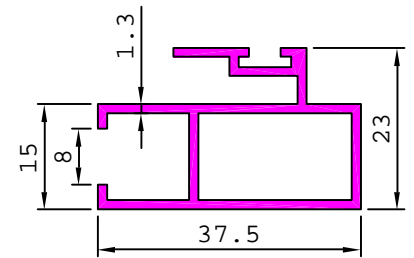

20690 0.366 kg/m

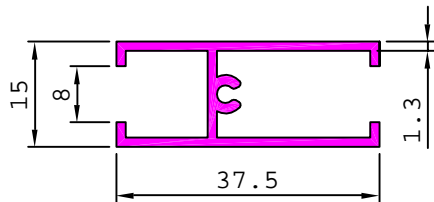

### PART III - S/W 1/2"

20952 0.304 kg/m

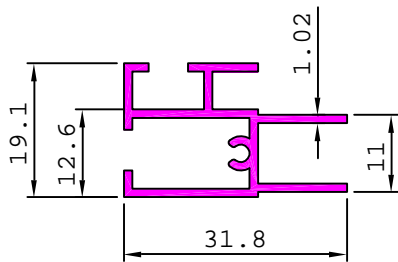

20953 0.455 kg/m

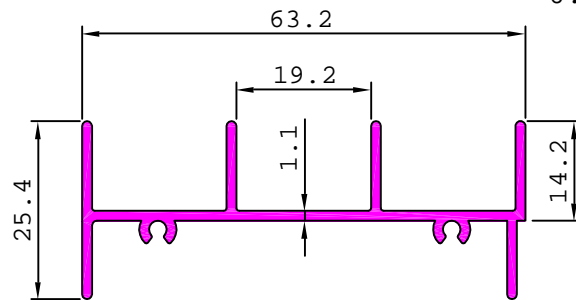

20959 0.547 kg/m

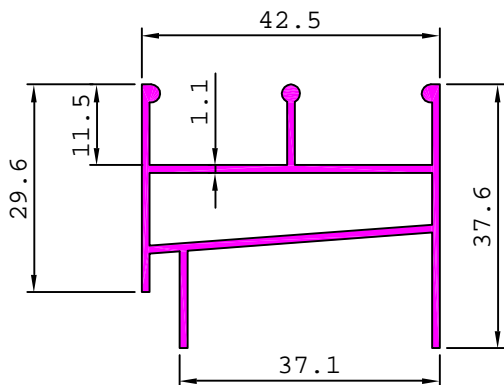

20960 0.329 kg/m

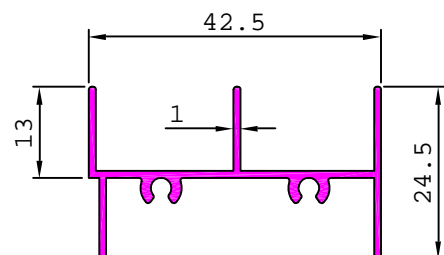

## DETAILS OF SLIDING WINDOW SECTIONS

### SERIES - A 15 mm.

### PART III - S/W 1/2"

20688

0.371 kg/m

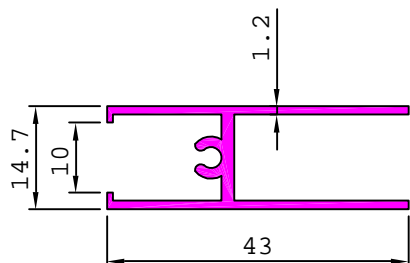

20886

0.411 kg/m

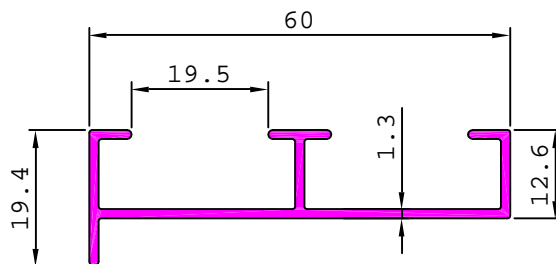

## DETAILS OF SLIDING WINDOW SECTIONS SERIES - B (SHUTTER SECTION - 18 mm.)

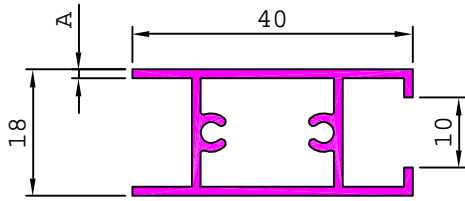

SL. No.	Section No.	A	Weight kg/m
1	20545	0.79	0.289
2	20805	0.91	0.325
3	20604	1.09	0.390
4	20844	1.29	0.456
5	20736	1.55	0.547

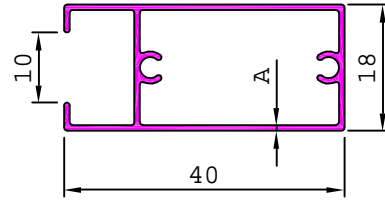

SL. No.	Section No.	A	Weight kg/m
1	20547	0.79	0.289
2	20807	0.91	0.325
3	20606	1.09	0.390
4	20846	1.29	0.456
5	20738	1.55	0.547

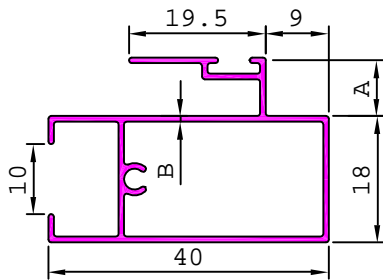

SL. No.	Section No.	A	B	Weight kg/m
1	20546	8.34	0.80	0.346
2	20806	9.00	0.89	0.380
3	20605	9.00	1.00	0.440
4	20845	9.00	1.29	0.547
5	20737	9.00	1.45	0.607

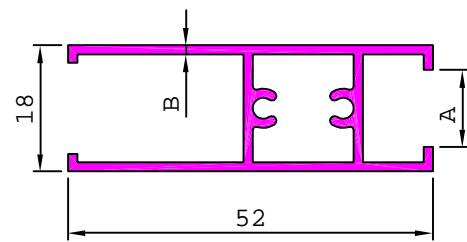

SL. No.	Section No.	A	B	Weight kg/m
1	20811	11.00	0.91	0.390
2	20963	11.00	1.13	0.488
3	20847	10.00	1.29	0.547
4	20652	11.00	1.30	0.547
4	20750	10.00	1.56	0.651

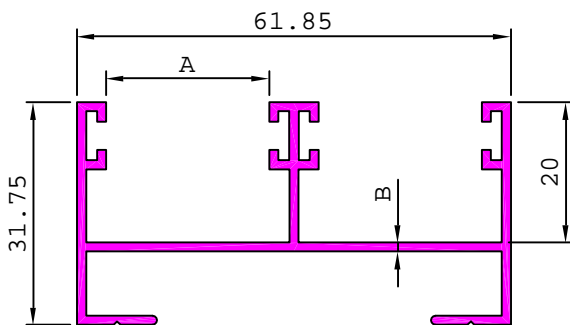

SL. No.	Section No.	A	B	Weight kg/m
1	20812	23.95	0.81	0.441
2	20966	23.85	1.00	0.547
3	20681	23.25	1.30	0.659
4	20829	22.70	1.50	0.784

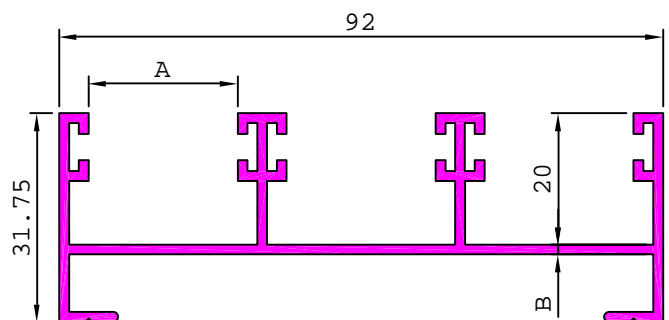

SL. No.	Section No.	A	B	Weight kg/m
1	20816	23.60	0.95	0.683
2	20958	23.60	1.05	0.759
3	20621	23.30	1.30	0.933
4	20831	22.70	1.50	1.060

## DETAILS OF SLIDING WINDOW SECTIONS SERIES - B (SHUTTER SECTION - 18 mm.)

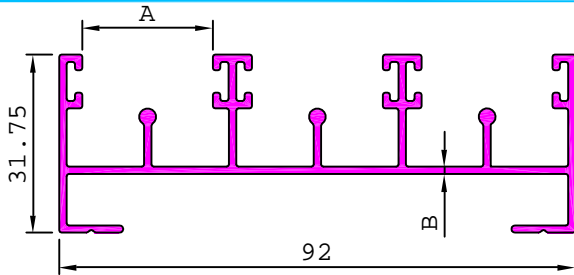

SL. No.	Section No.	A	B	Weight kg/m
1	20815	23.60	0.88	0.739
2	20957	23.60	1.10	0.911
3	20620	23.30	1.30	1.070
4	20832	22.70	1.50	1.248

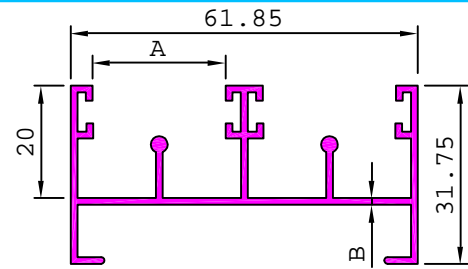

SL. No.	Section No.	A	B	Weight kg/m
1	20813	23.95	0.85	0.497
2	20956	23.85	1.05	0.621
3	20619	23.70	1.20	0.695
4	20830	22.70	1.50	0.909

20674 1.829 kg/m

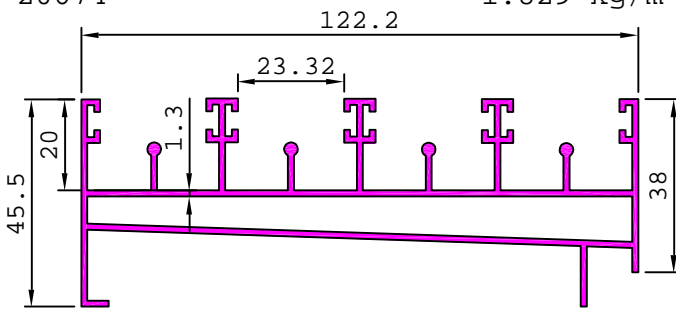

20667 1.148 kg/m

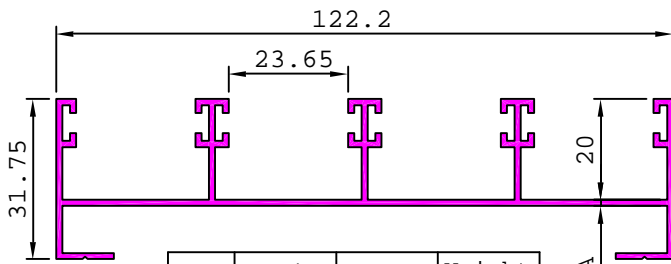
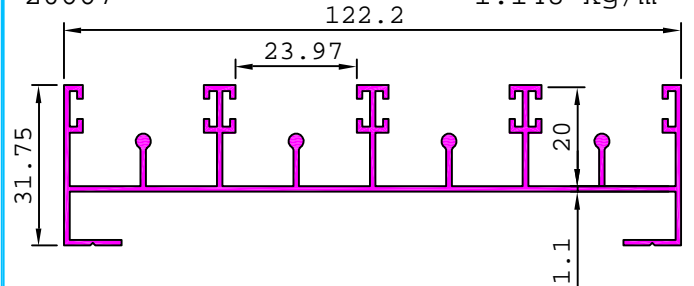

SL. No.	Section No.	A	Weight kg/m
1	20817	1.10	0.976
2	20666	1.20	1.093

20833 1.398 kg/m

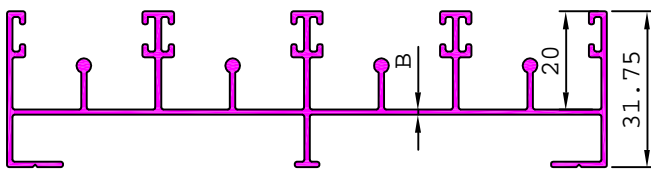
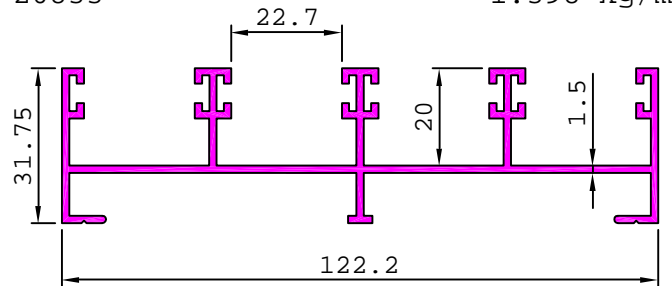

SL. No.	Section No.	A	B	Weight kg/m
1	20818	23.90	1.00	1.093
2	20706	23.90	1.10	1.205
3	20834	22.70	1.50	1.648

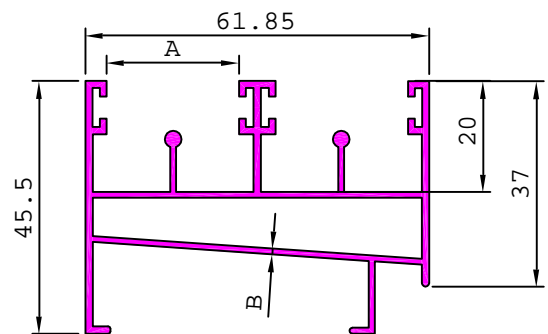

SL. No.	Section No.	A	B	Weight kg/m
1	20965	23.85	1.05	0.882
2	20657	23.45	1.30	1.055

## DETAILS OF SLIDING WINDOW SECTIONS SERIES - B (SHUTTER SECTION - 18 mm.)

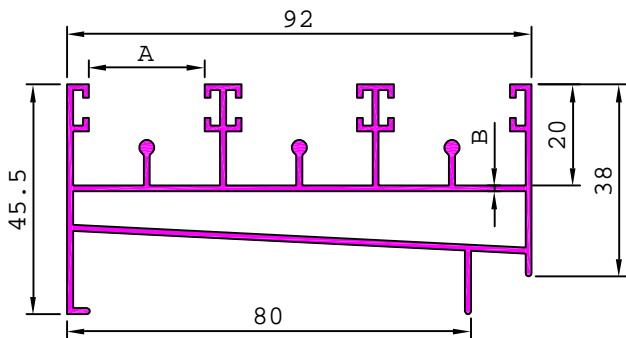

SL. No.	Section No.	A	B	Weight kg/m
1	20814	22.95	1.18	1.302
2	21031	22.95	1.30	1.441
3	20617	22.70	1.50	1.659

20635

1.130 kg/m

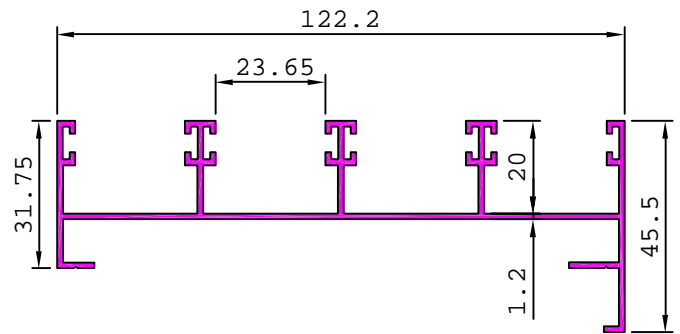

20920 0.503 kg/m

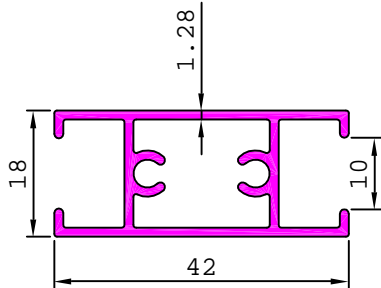

20839 0.492 kg/m

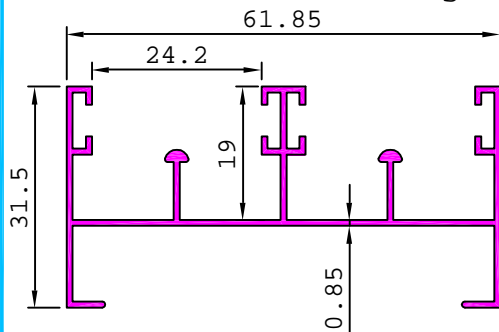

20645 1.690 kg/m

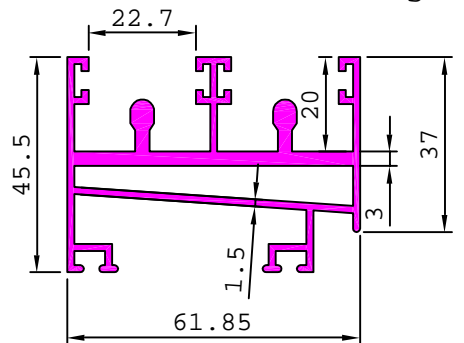

20636 1.388 kg/m

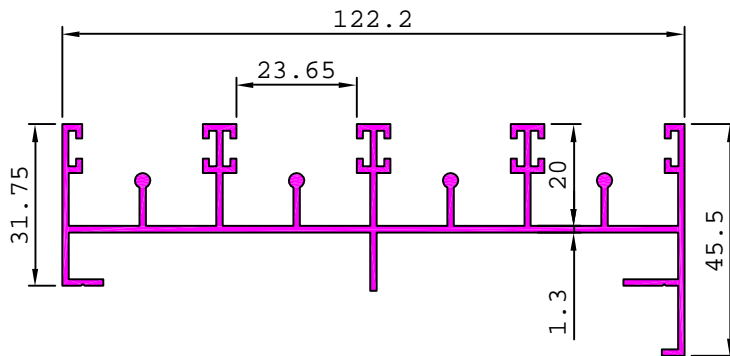

20702 1.284 kg/m

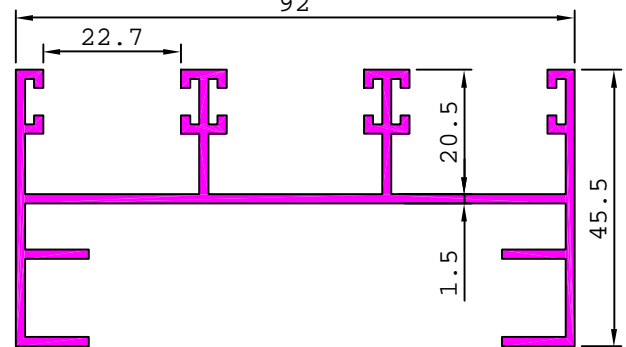

20684 0.547 kg/m

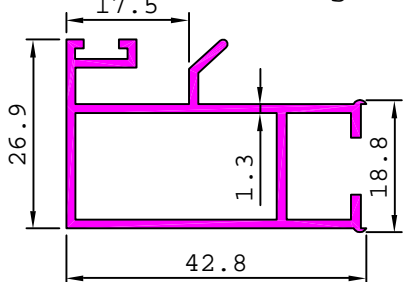

20685 0.463 kg/m

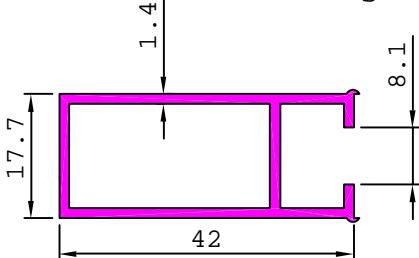

20686 0.558 kg/m

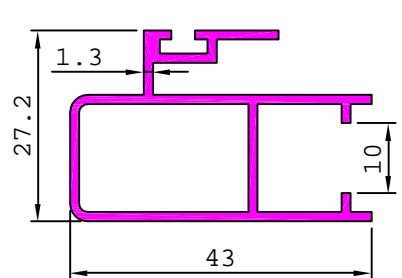

## DETAILS OF SLIDING WINDOW SECTIONS SERIES - B (SHUTTER SECTION - 18 mm.)

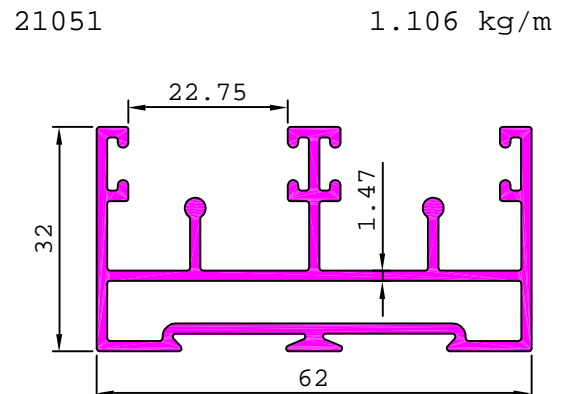
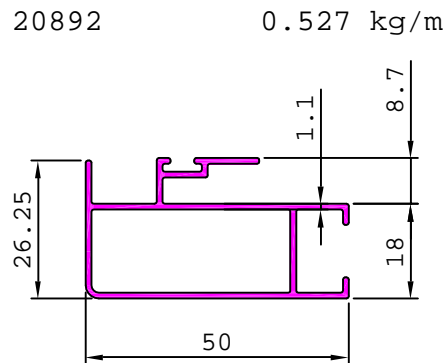
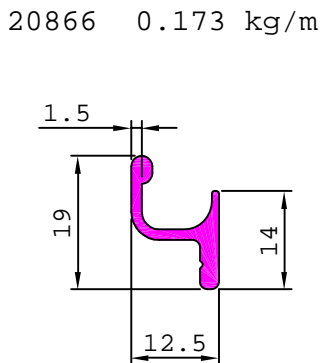
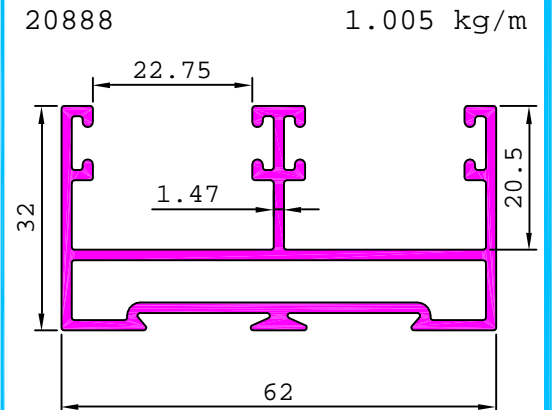
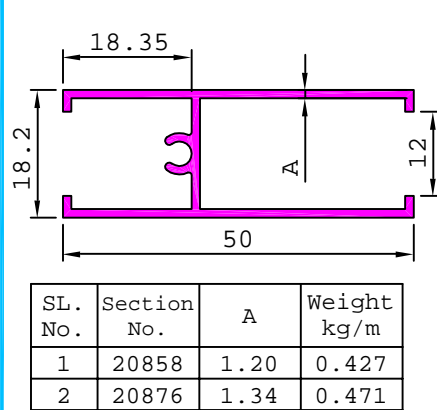
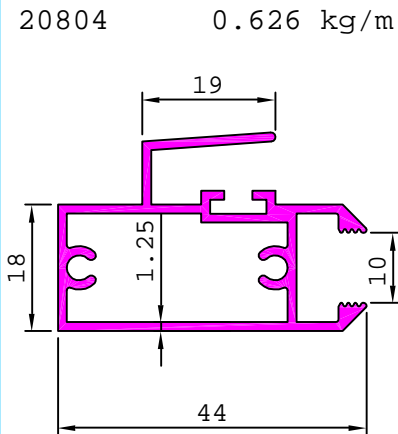
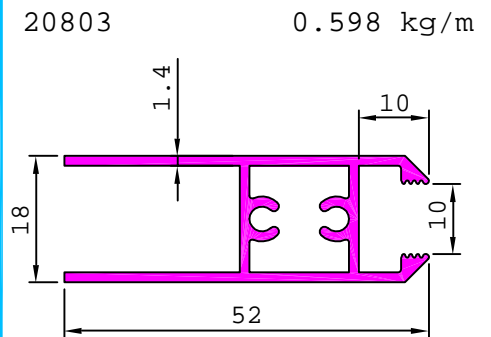
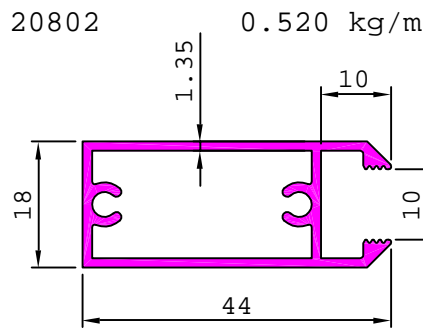
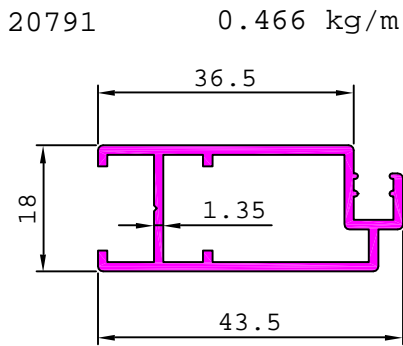
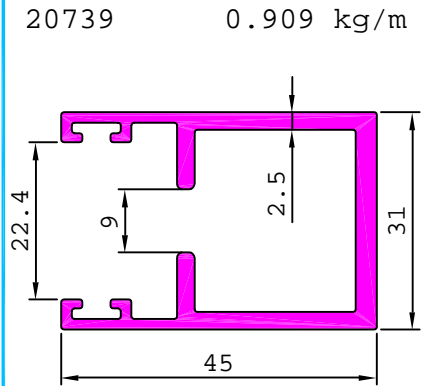
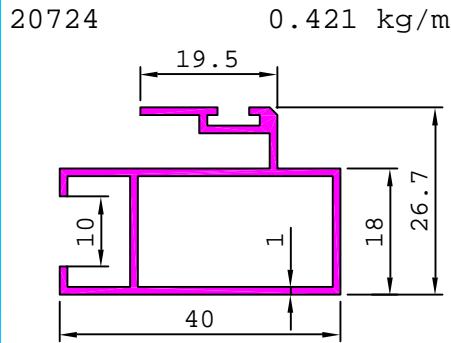
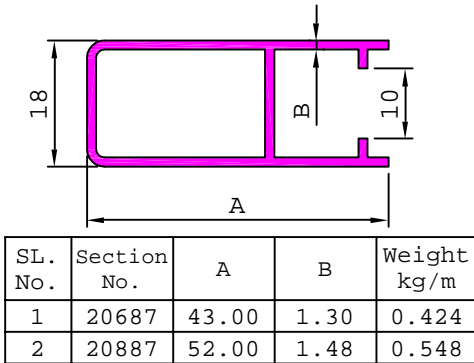

## DETAILS OF SLIDING WINDOW SECTIONS SERIES - B (SHUTTER SECTION - 18 mm.)

20924

0.683 kg/m

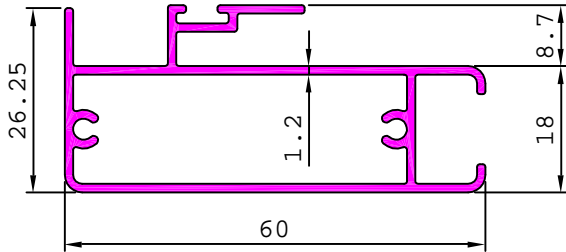

20925

0.549 kg/m

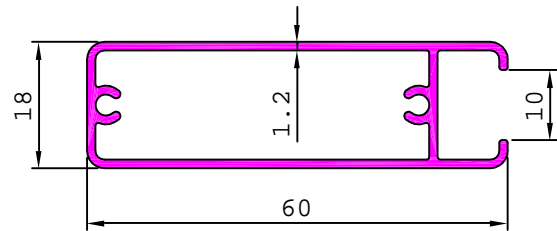

20926

0.641 kg/m

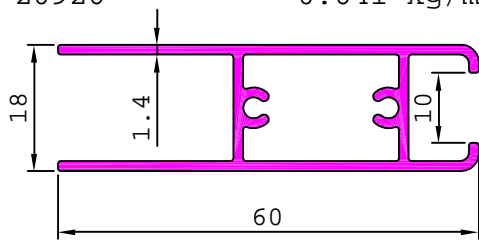

20893

0.434 kg/m

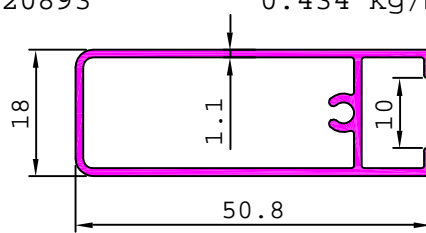

20576

0.663 kg/m

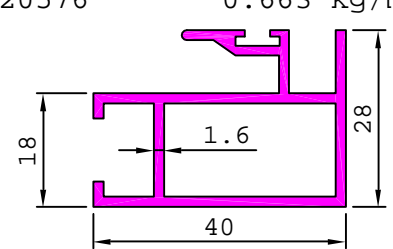

20532

0.304 kg/m

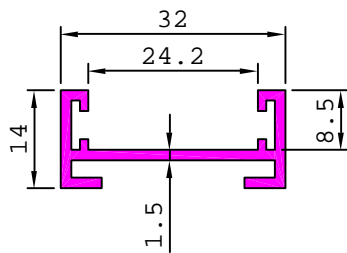

20567

0.601 kg/m

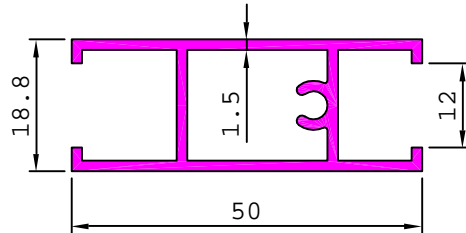

20577

0.522 kg/m

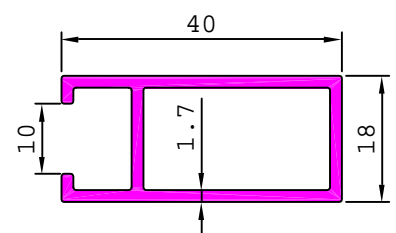

21028

1.792 kg/m

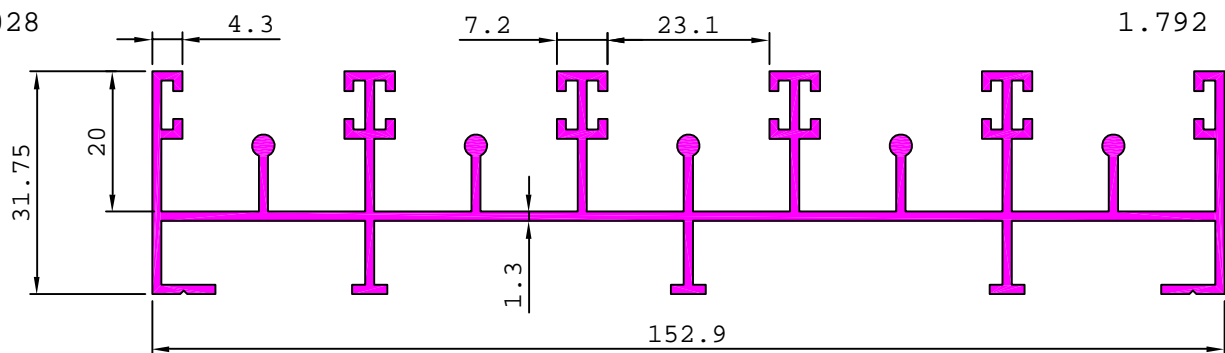

21029

1.523 kg/m

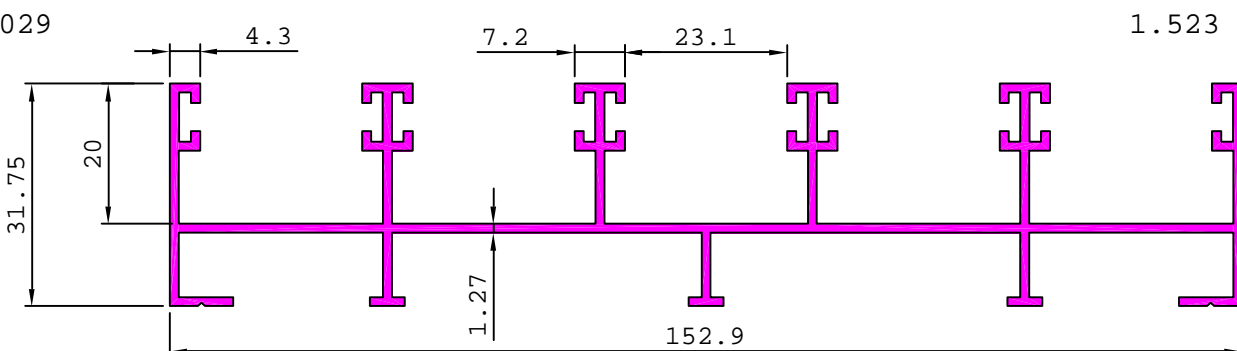

## DETAILS OF SLIDING WINDOW SECTIONS

### SERIES - C (SHUTTER SECTION - 20 mm.) PART I - IV

20529

0.642 kg/m

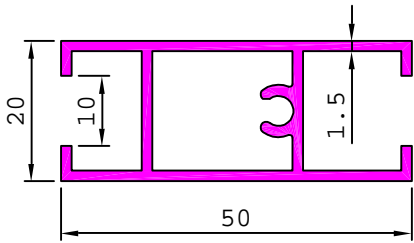

20530

0.571 kg/m

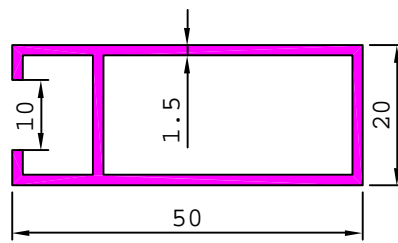

20531

0.697 kg/m

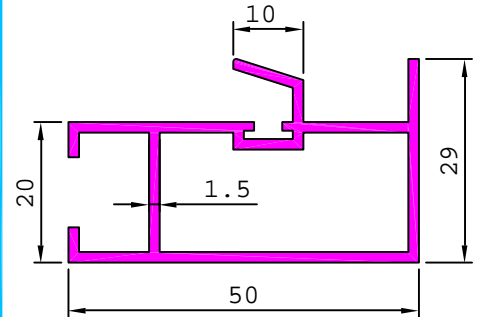

### PART - II

20544

0.495 kg/m

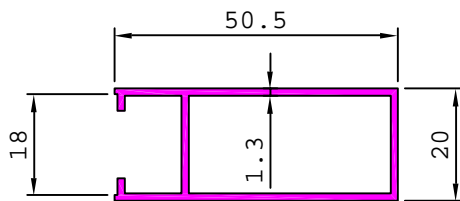

20566

0.693 kg/m

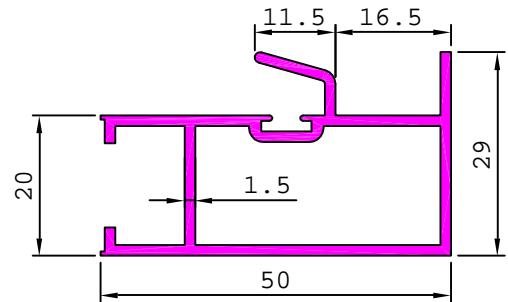

20567

0.601 kg/m

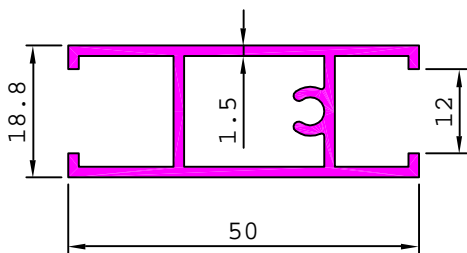

20840

0.594 kg/m

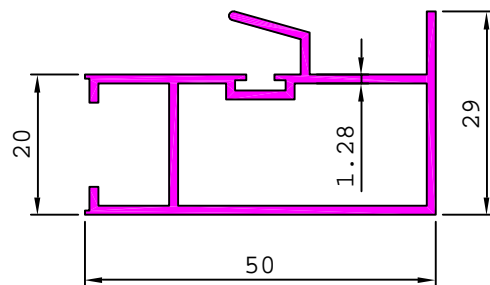

### PART - III

20694

0.695 kg/m

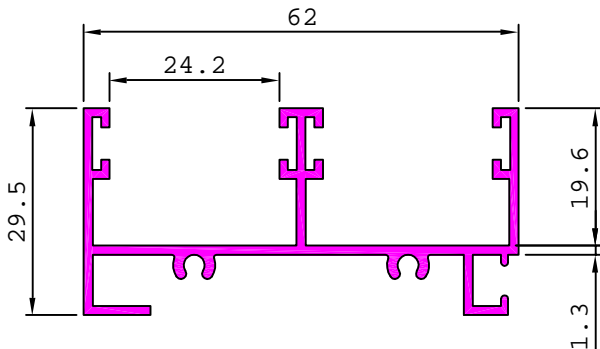

20695

1.088 kg/m

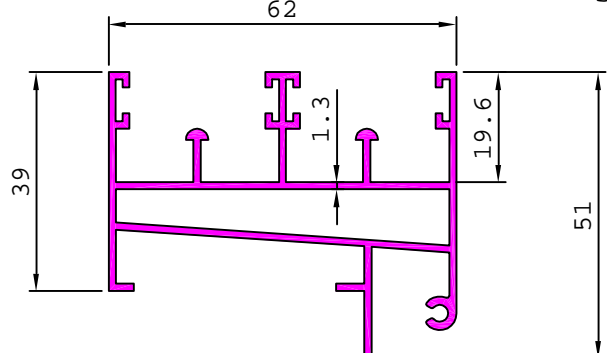

## DETAILS OF SLIDING WINDOW SECTIONS

### PART - III

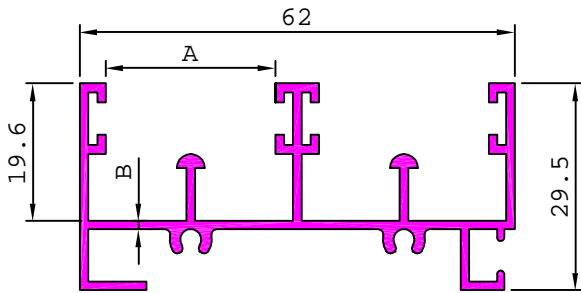

SL. No.	Section No.	A	B	Weight kg/m
1	21053	24.20	1.00	0.630
2	20703	24.20	1.20	0.726
3	21139	23.30	1.50	0.902

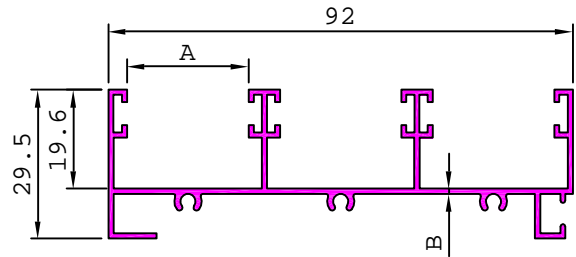

SL. No.	Section No.	A	B	Weight kg/m
1	21054	24.10	1.05	0.777
2	20696	24.10	1.20	0.907
3	20978	23.20	1.40	1.066
4	21137	23.20	1.50	1.102
4	21100	23.05	2.00	1.342

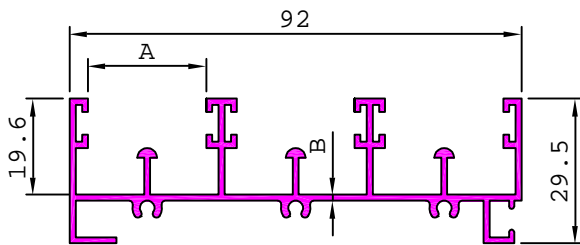

SL. No.	Section No.	A	B	Weight kg/m
1	21055	24.10	1.00	0.866
2	20704	24.10	1.20	1.005
3	20977	23.20	1.45	1.217
4	21099	23.05	2.00	1.516

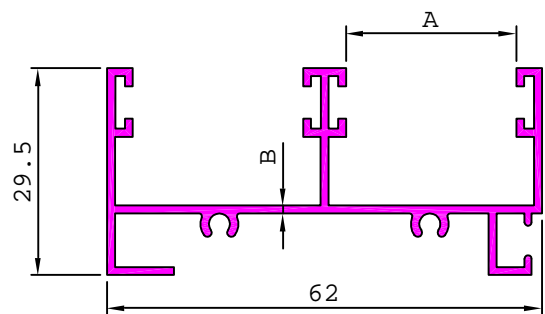

SL. No.	Section No.	A	B	Weight kg/m
1	20987	24.30	1.13	0.615
2	21138	23.30	1.50	0.807

### PART - IV

20697

1.374 kg/m

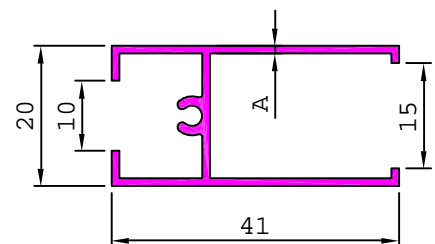
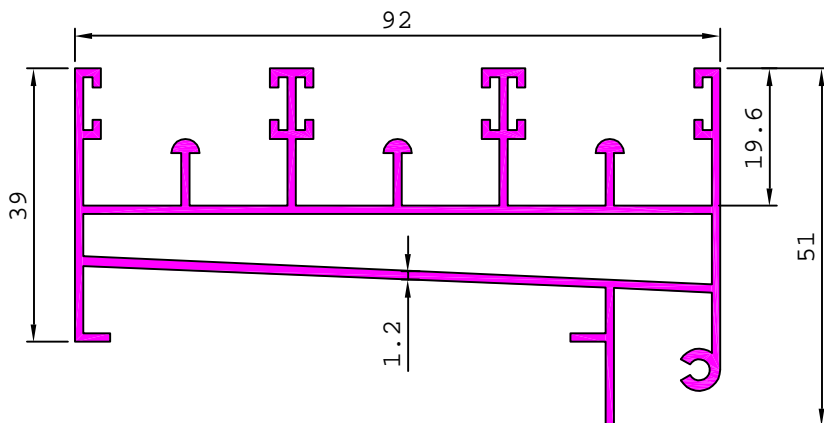

SL. No.	Section No.	A	Weight kg/m
1	20988	0.98	0.314
2	20710	1.10	0.355
3	21092	2.00	0.606

## DETAILS OF SLIDING WINDOW SECTIONS

### PART - IV

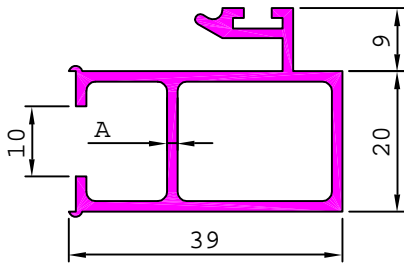

SL. No.	Section No.	A	Weight kg/m
1	21052	1.00	0.409
2	20976	1.15	0.473
3	20708	1.50	0.605
4	21094	2.00	0.734

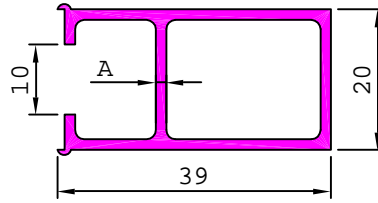

SL. No.	Section No.	A	Weight kg/m
1	20968	0.80	0.277
2	20931	1.00	0.342
3	20975	1.25	0.418
4	20709	1.50	0.488
5	21093	2.00	0.634

20551

0.484 kg/m

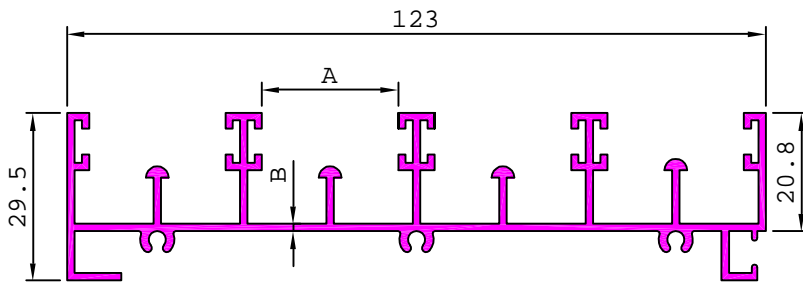
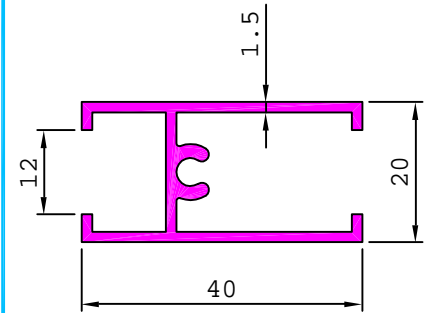

SL. No.	Section No.	A	B	Weight kg/m
1	20910	24.00	1.30	1.394
2	21101	23.30	2.00	1.915

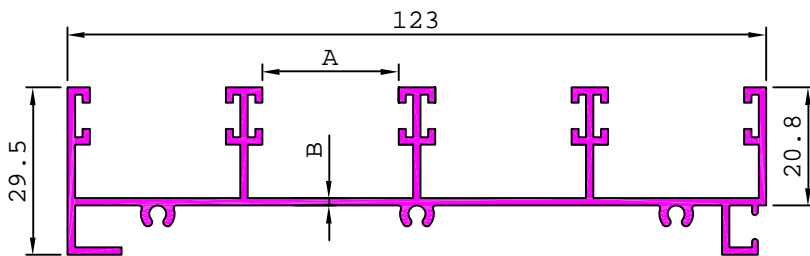

SL. No.	Section No.	A	B	Weight kg/m
1	20911	24.00	1.30	1.207
2	21098	23.30	2.00	1.670

21022 0.539 kg/m

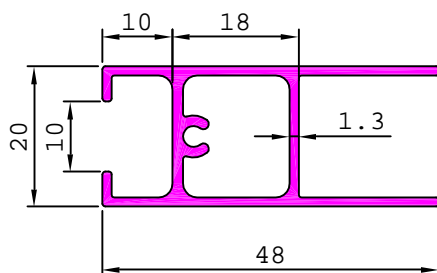

21216 1.233 kg/m

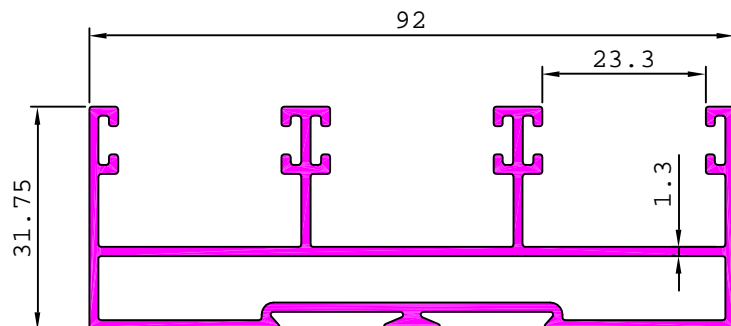

## DETAILS OF SLIDING WINDOW SECTIONS SERIES - D (SHUTTER SECTION - 25 mm.) PART I

20506 0.717 kg/m

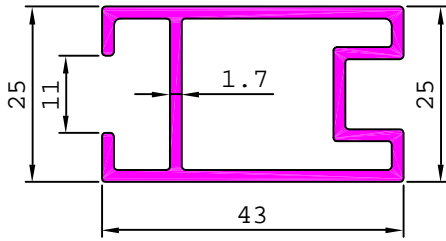

20507 0.642 kg/m

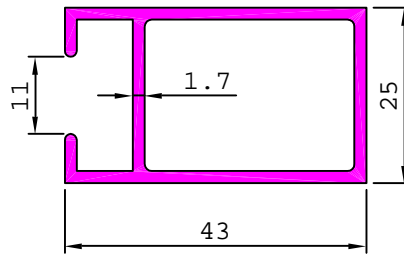

20516 0.560 kg/m

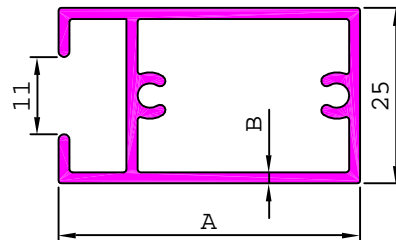
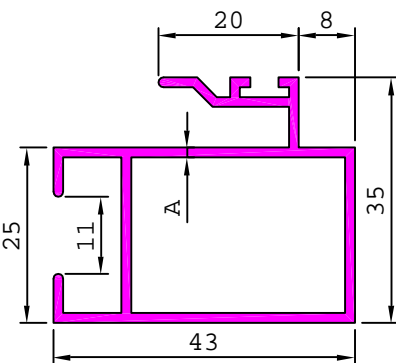
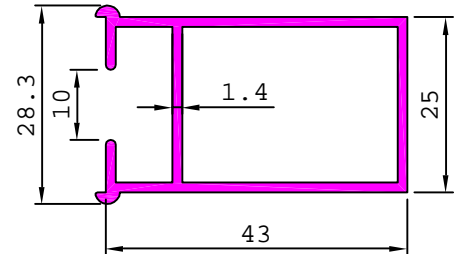

20517 0.708 kg/m

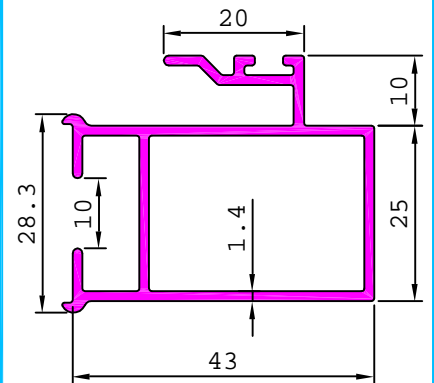

SL. No.	Section No.	A	Weight kg/m
1	20939	1.40	0.678
2	20508	1.70	0.802

SL. No.	Section No.	A	B	Weight kg/m
1	20841	43.00	1.33	0.569
2	20602	43.00	1.57	0.665
3	21030	43.00	1.98	0.828
4	20707	50.00	1.20	0.593
5	21056	50.00	1.51	0.717

20518 0.675 kg/m

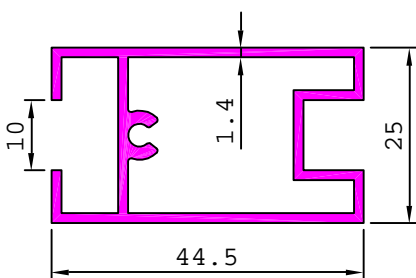

20675 0.274 kg/m

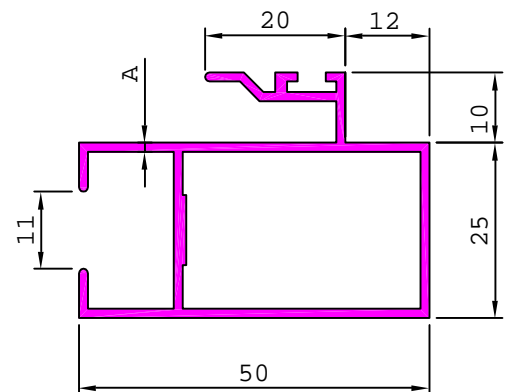
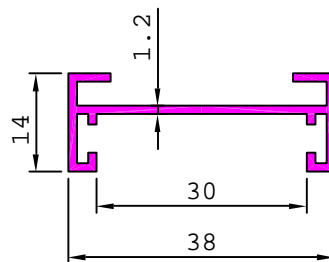

20633 0.676 kg/m

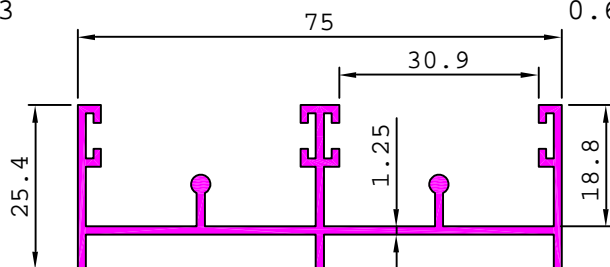

SL. No.	Section No.	A	Weight kg/m
1	20741	1.30	0.683
2	21091	1.48	0.776

## DETAILS OF SLIDING WINDOW SECTIONS SERIES - D (SHUTTER SECTION - 25 mm.) PART I

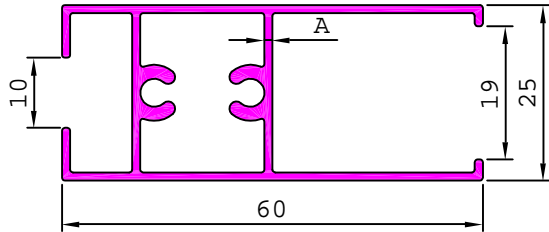

SL. No.	Section No.	A	Weight kg/m
1	20639	1.15	0.672
2	20842	1.45	0.781

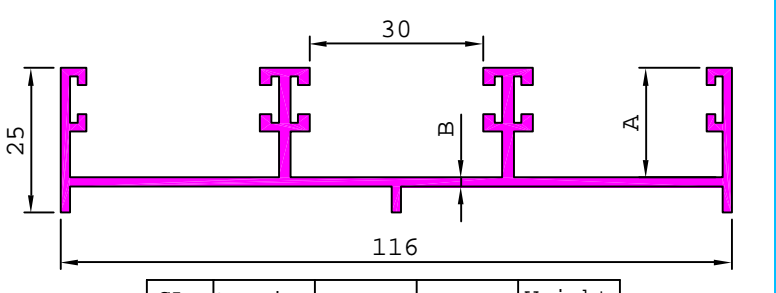
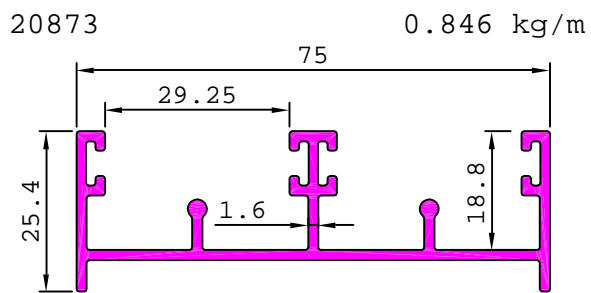
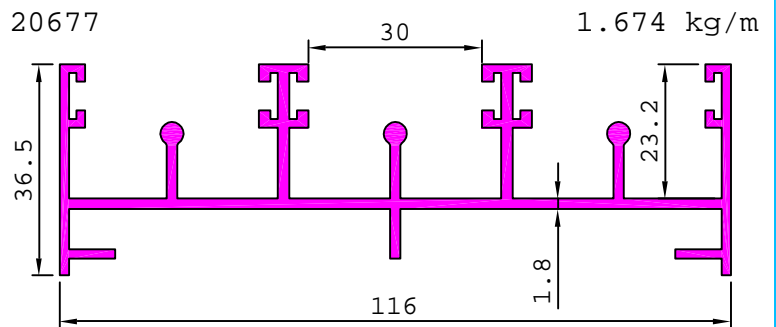
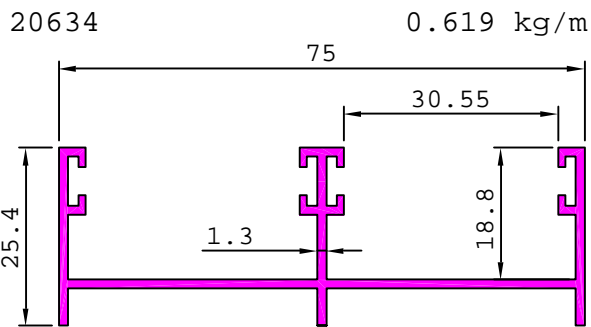

SL. No.	Section No.	A	B	Weight kg/m
1	21032	19.10	1.40	1.005
2	20678	18.90	1.60	1.194

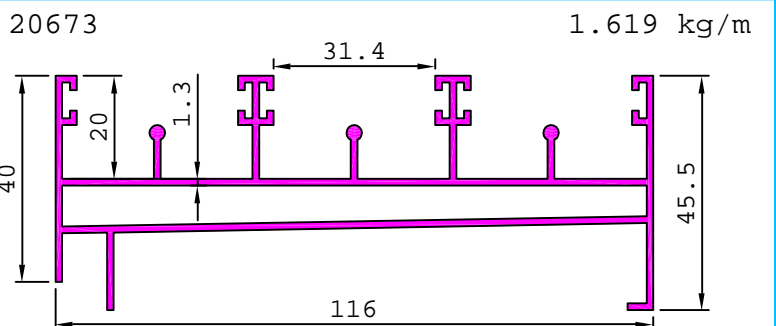
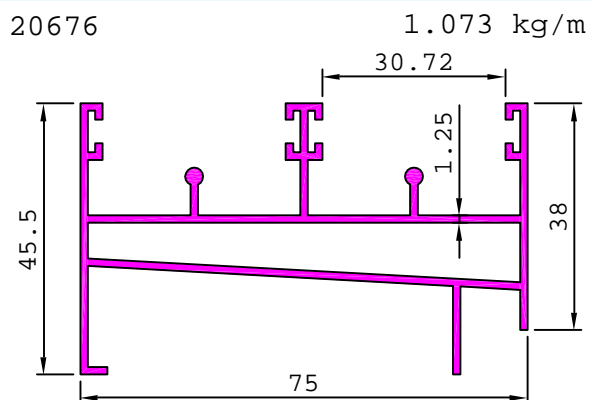
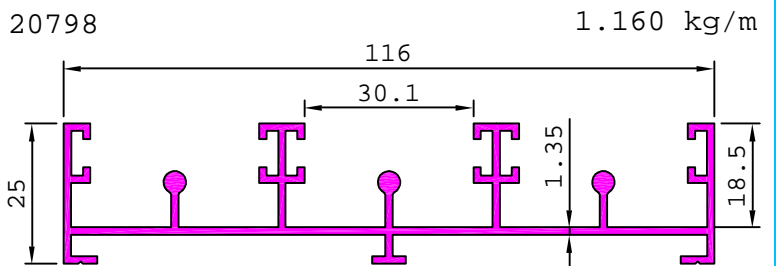
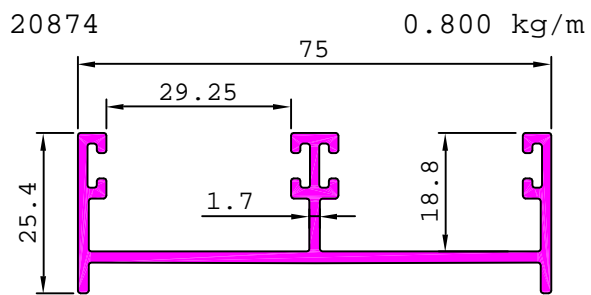

## DETAILS OF SLIDING WINDOW SECTIONS SERIES - D (SHUTTER SECTION - 25 mm.) PART I

20796

1.434 kg/m

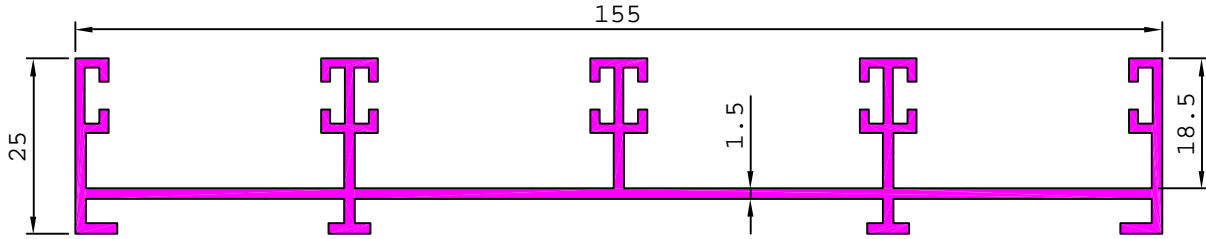

20797

1.667 kg/m

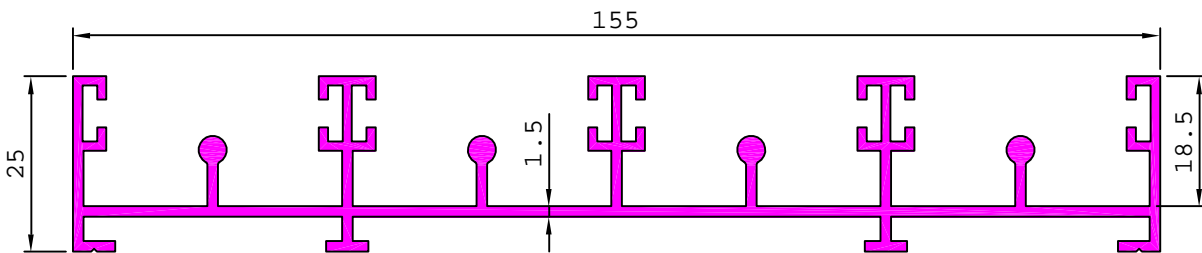

## SERIES - D (SHUTTER SECTION - 25 mm.) PART II

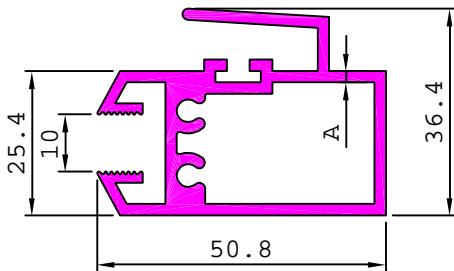

SL. No.	Section No.	A	Weight kg/m
1	21145	1.50	0.985
2	20711	1.68	1.090

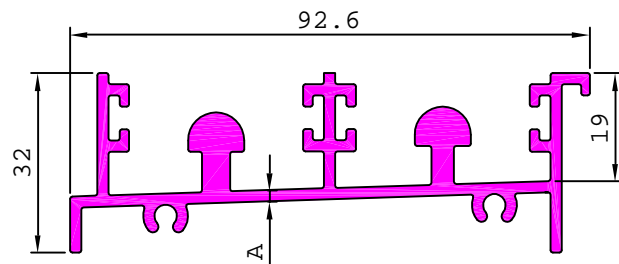

SL. No.	Section No.	A	B	Weight kg/m
1	21146	32.15	1.50	1.308
2	20712	31.00	2.00	1.805

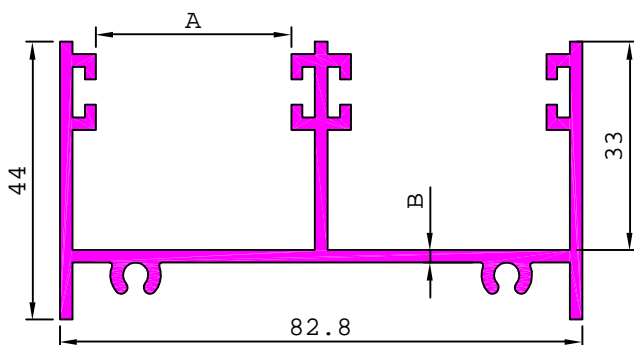

SL. No.	Section No.	A	B	Weight kg/m
1	21147	32.15	1.50	1.073
2	20713	31.00	2.00	1.429

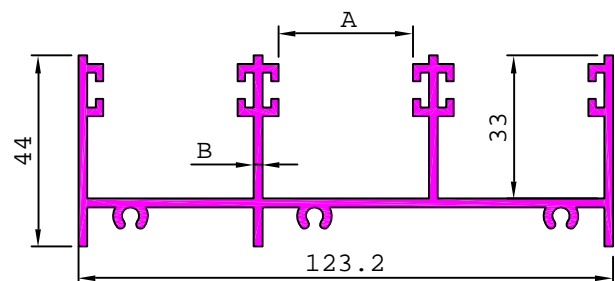

SL. No.	Section No.	A	B	Weight kg/m
1	21149	32.10	1.50	1.539
2	20714	31.00	2.00	2.062

## DETAILS OF SLIDING WINDOW SECTIONS SERIES - D (SHUTTER SECTION - 25 mm.) PART II

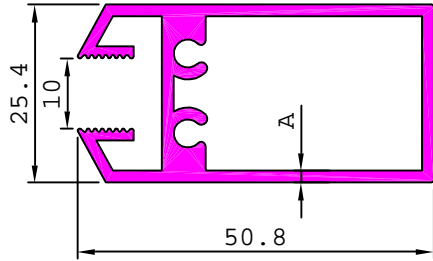

SL. No.	Section No.	A	Weight kg/m
1	21144	1.50	0.797
2	20715	1.70	0.879

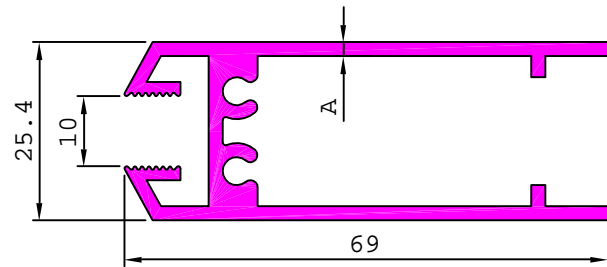

SL. No.	Section No.	A	Weight kg/m
1	21143	1.50	0.882
2	20716	2.00	1.119

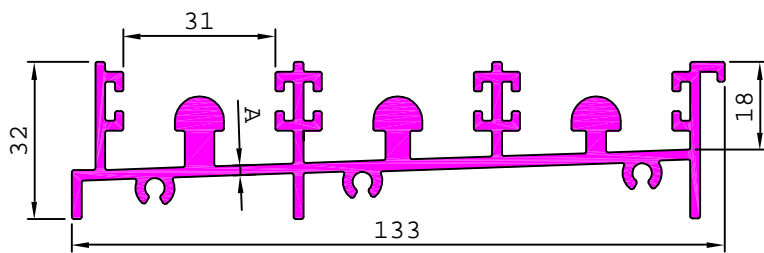

SL. No.	Section No.	A	Weight kg/m
1	21148	1.50	1.842
2	20717	2.00	2.572

20801 1.237 kg/m

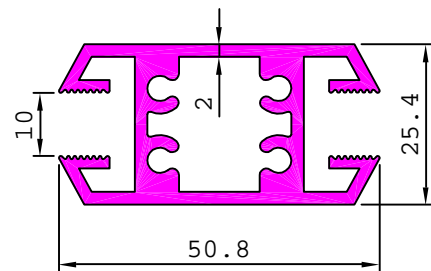

20528 0.781 kg/m

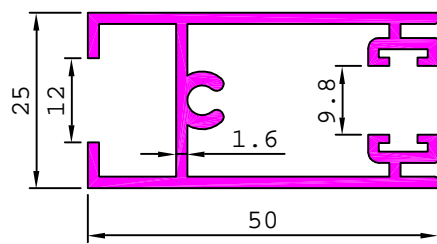

20543 0.669 kg/m

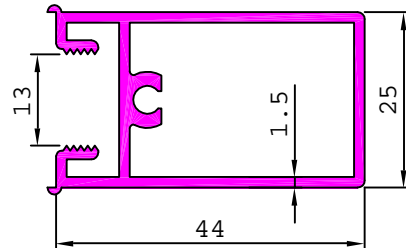

20921 0.584 kg/m

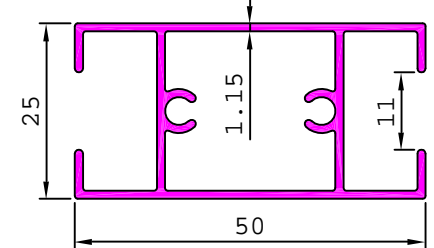

20732 0.669 kg/m

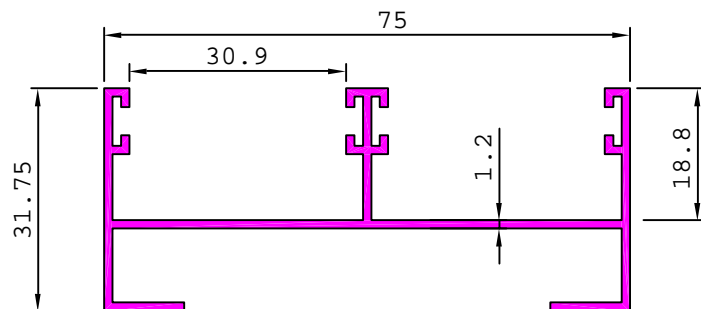

20740 1.006 kg/m

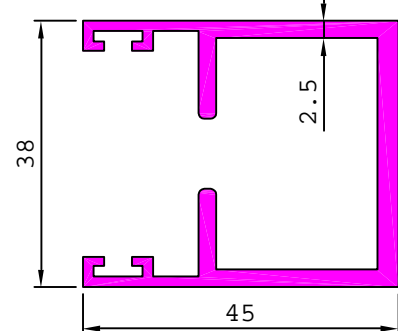

**DETAILS OF SLIDING WINDOW SECTIONS  
SERIES - D (SHUTTER SECTION - 25 mm.) PART II**

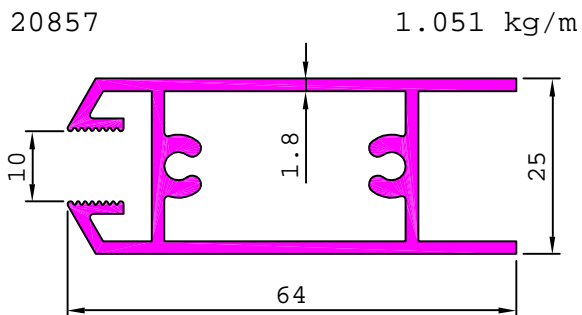
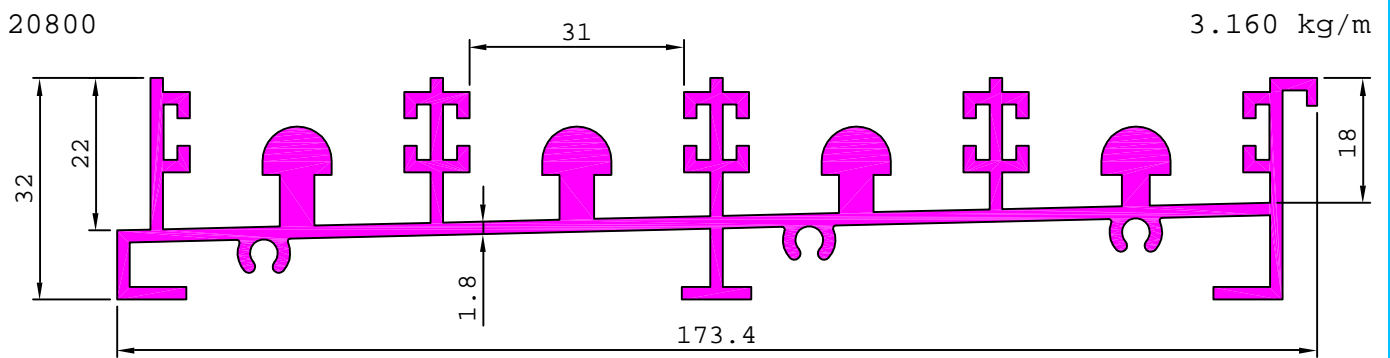
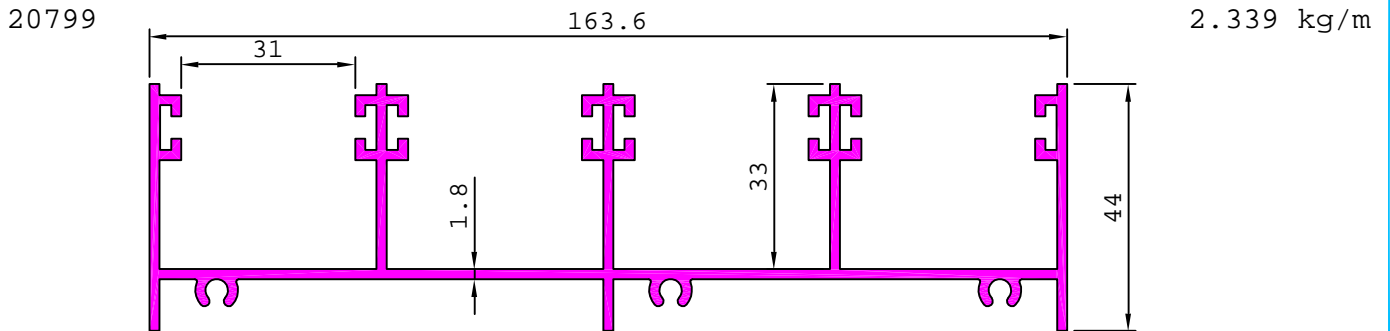

## DETAILS OF SLIDING WINDOW SECTIONS SERIES - E (SHUTTER SECTION - 30 mm.)

20549 0.809 kg/m

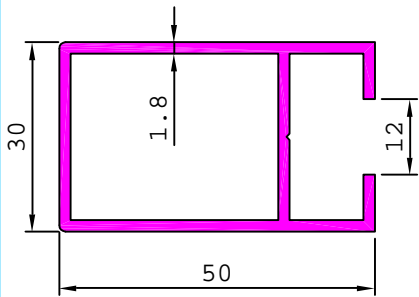

20550 0.994 kg/m

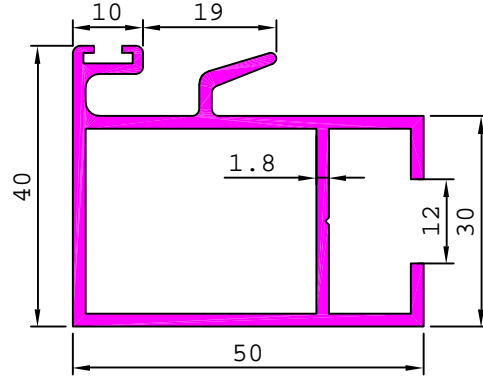

20553 0.731 kg/m

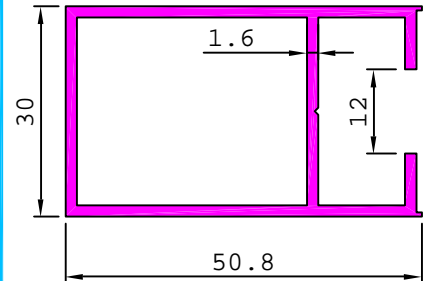

20835 0.904 kg/m

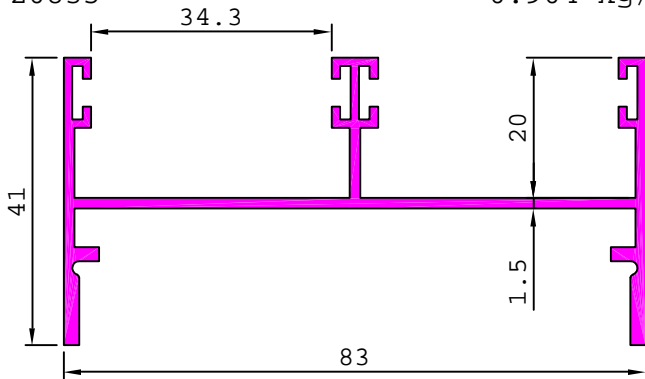

20836 1.039 kg/m

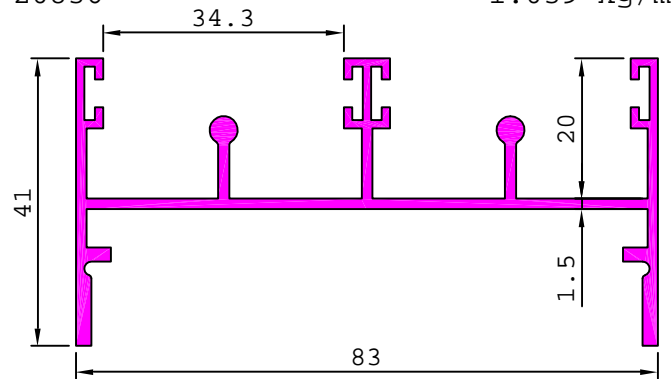

20837 1.197 kg/m

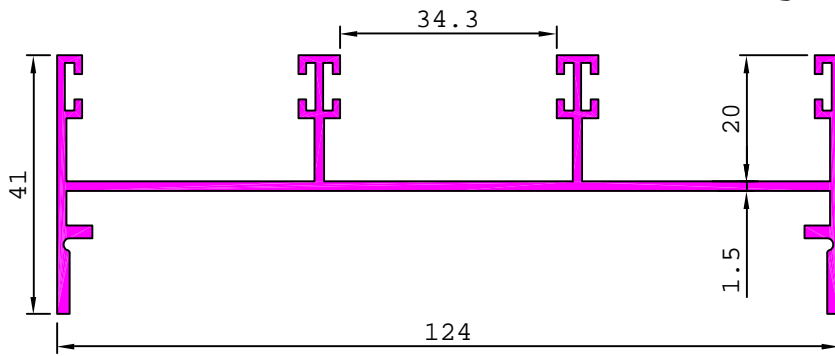

20555 0.869 kg/m

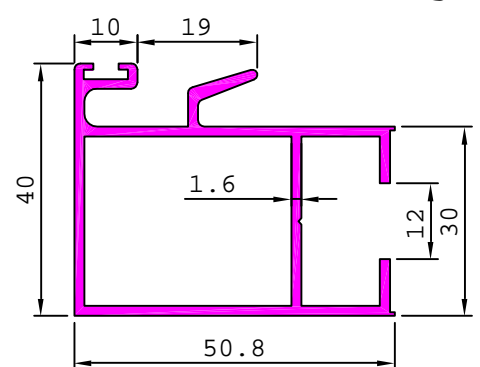

20838 1.518 kg/m

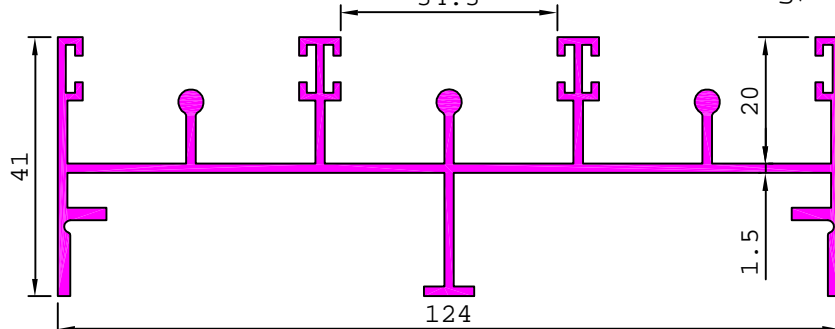

20859 0.775 kg/m

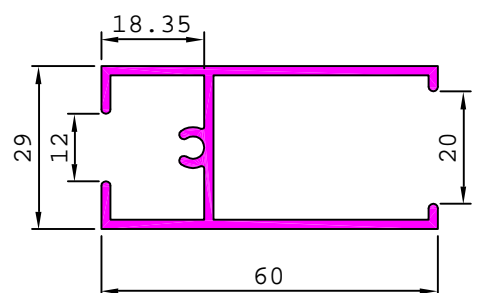

## DETAILS OF SLIDING WINDOW SECTIONS SERIES - E (SHUTTER SECTION - 30 mm.)

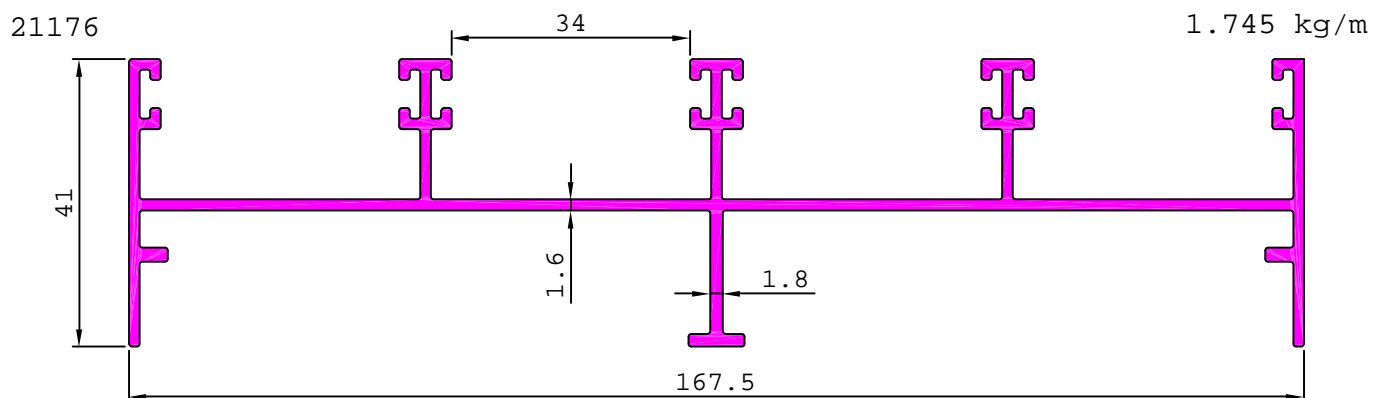
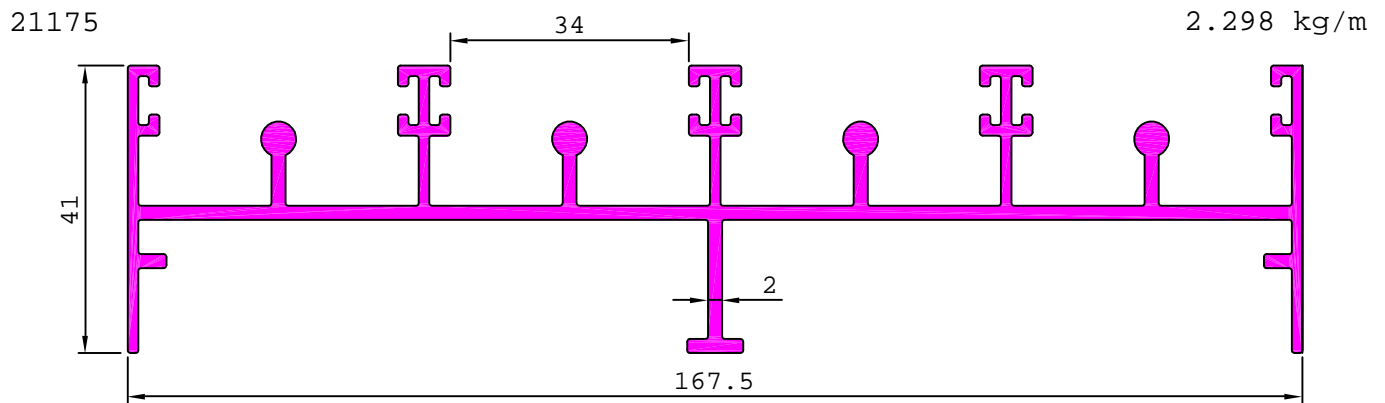
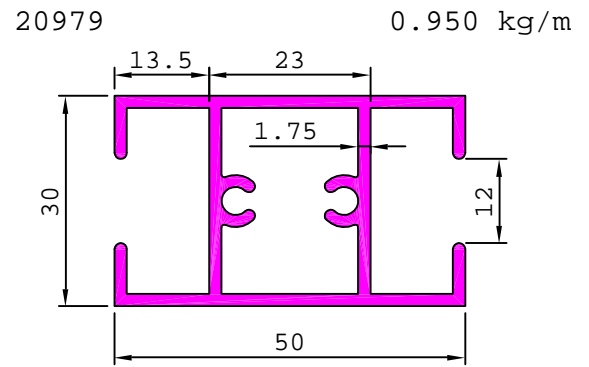
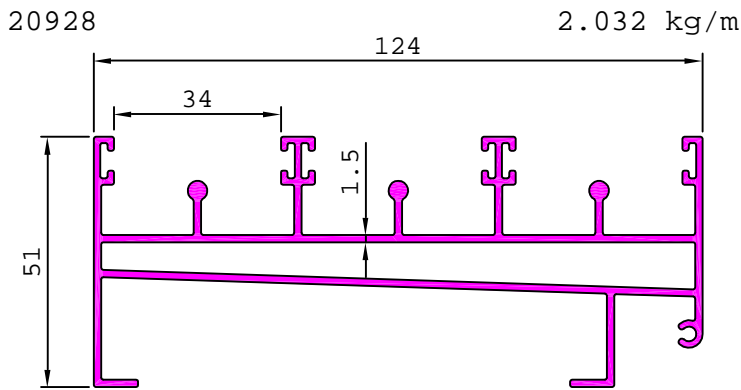
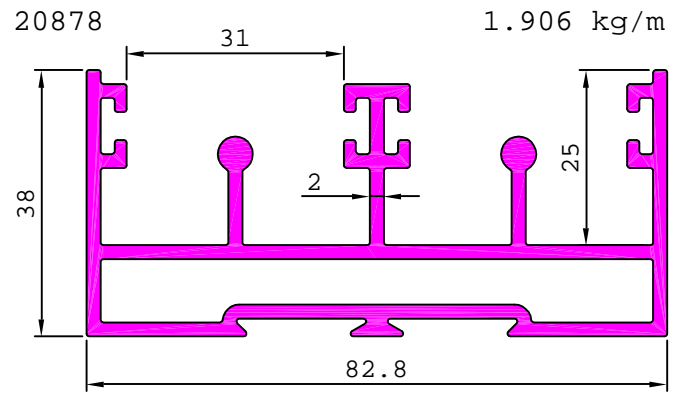
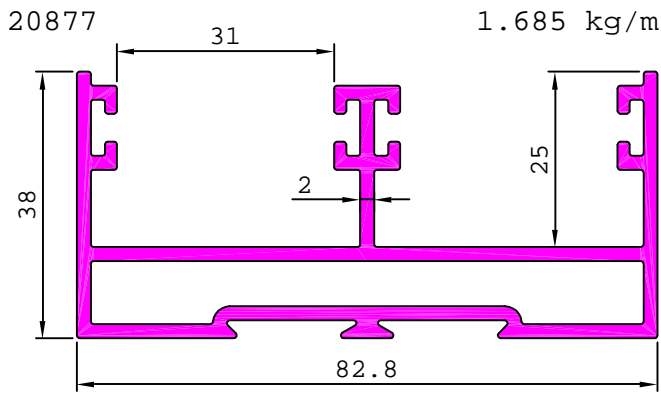

## DETAILS OF SLIDING WINDOW SECTIONS SERIES - E (SHUTTER SECTION - 30 mm.)

21198

3.197 kg/m

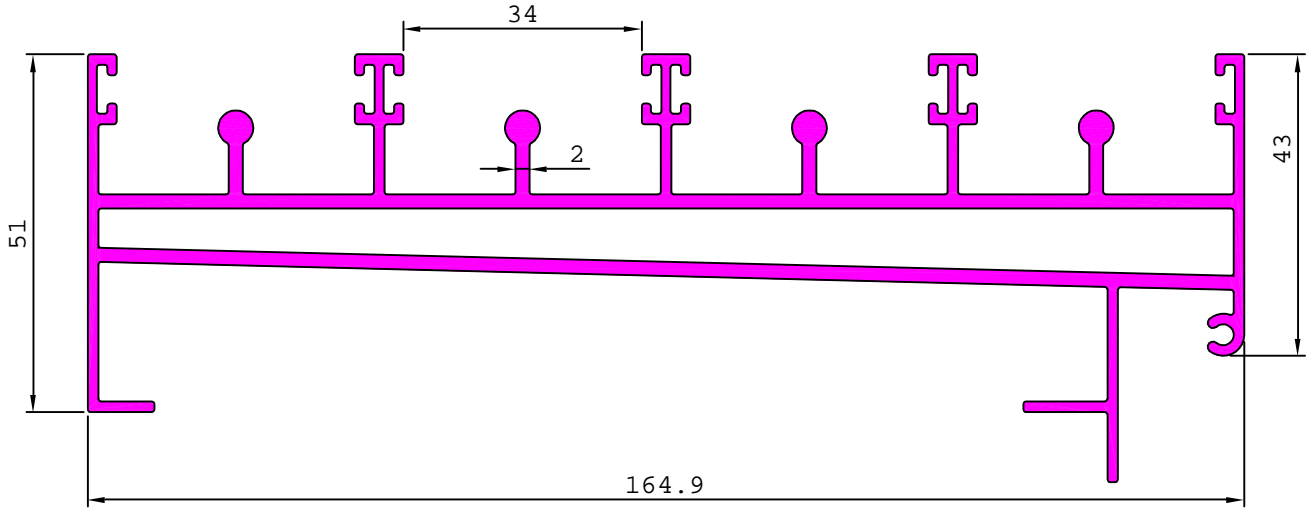

21203

2.073 kg/m

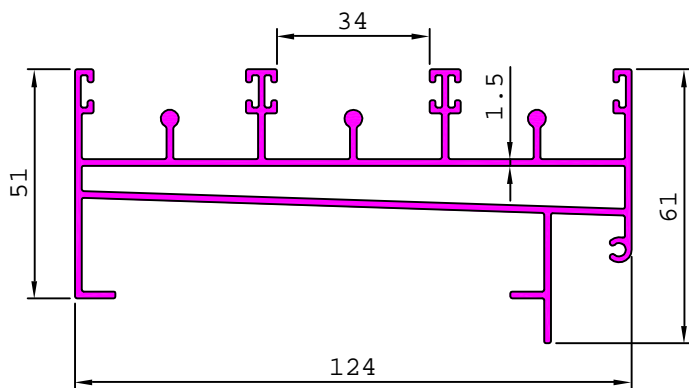

21217

1.502 kg/m

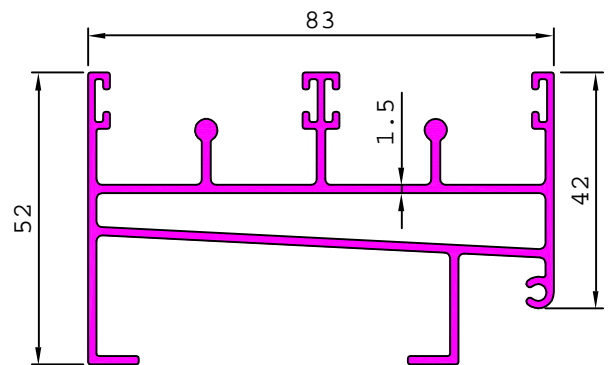

21204

1.694 kg/m

