

LADDERS

22501

0.350 kg/m

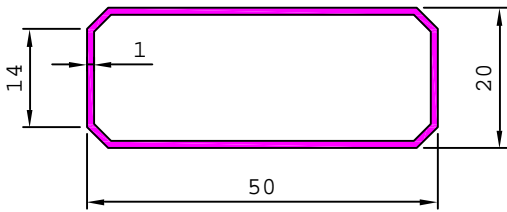

22502

0.252 kg/m

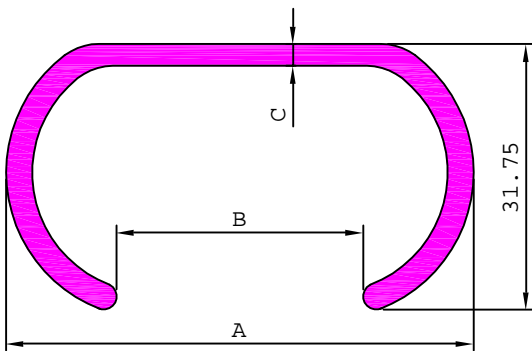
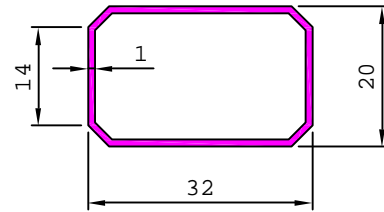

SL. No.	Section No.	A	B	C	Weight kg/m
1	22552	62.00	40.00	1.10	0.335
2	22544	66.65	41.30	1.20	0.410
3	22511	66.65	41.30	1.81	0.607
4	22503	66.65	41.30	2.54	0.837
5	22504	66.67	41.27	3.18	1.046
6	22505	66.68	47.00	4.00	1.247

22506

0.767 kg/m

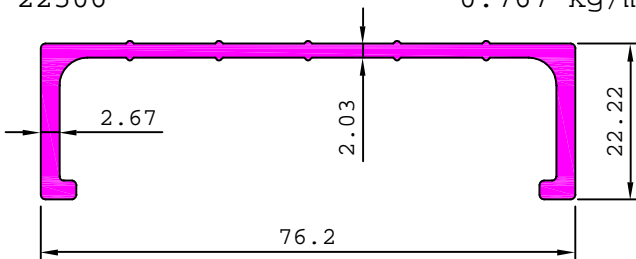

22507

0.673 kg/m

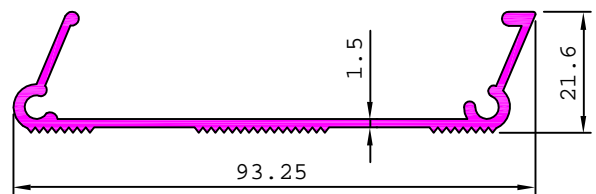

22508

0.662 kg/m

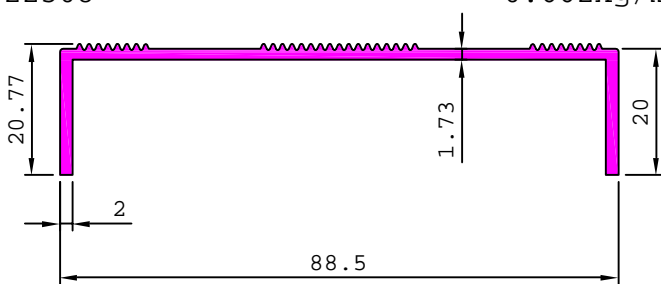

22510

0.769 kg/m

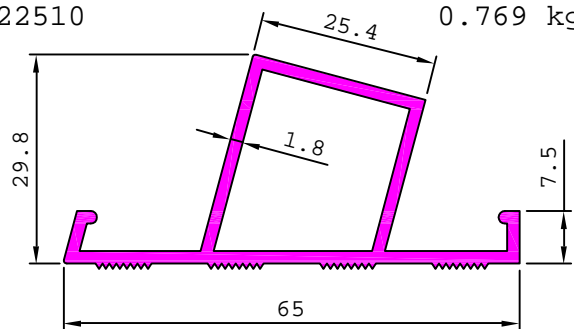

22512

0.575 kg/m

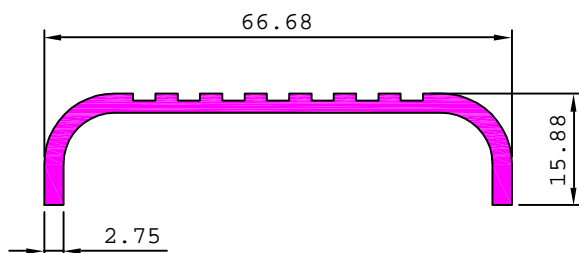

22513

0.976 kg/m

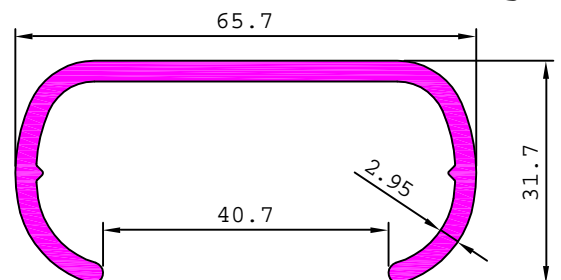

LADDERS

22515

0.535 kg/m

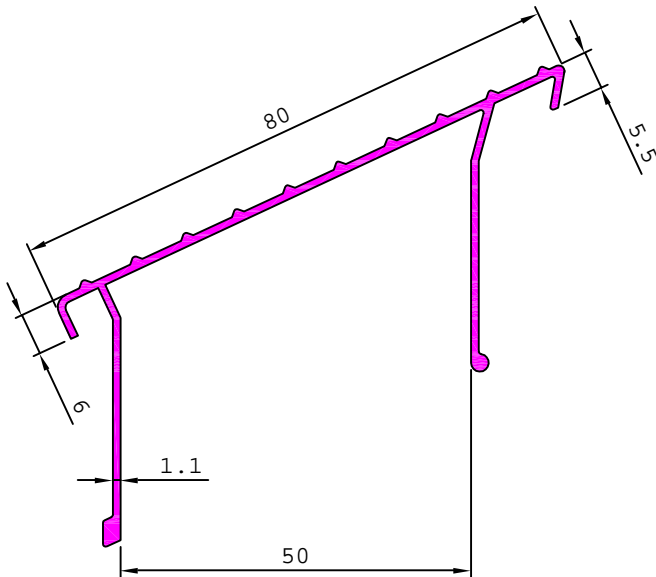

22516

1.009 kg/m

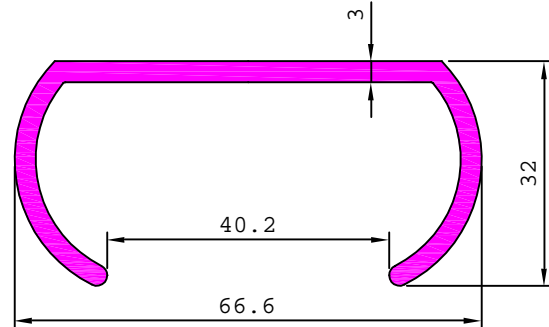

22518

0.871 kg/m

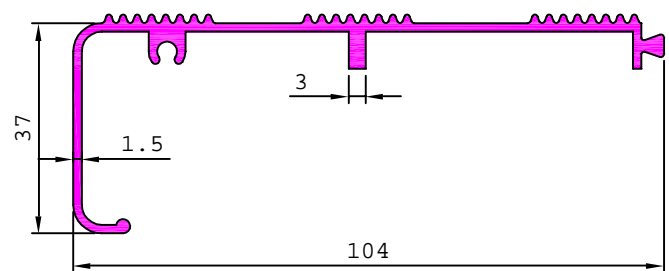

22519

0.659 kg/m

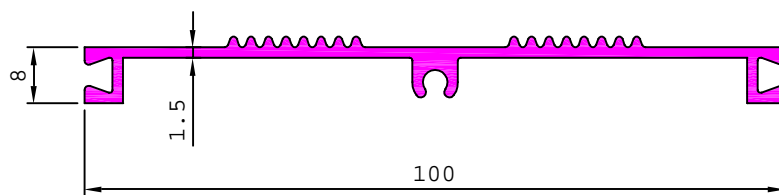

22520

1.044 kg/m

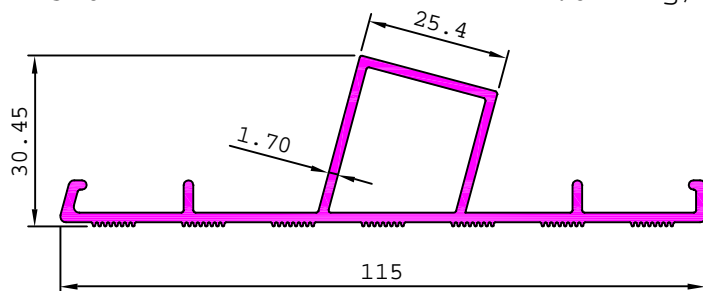

22522

0.536 kg/m

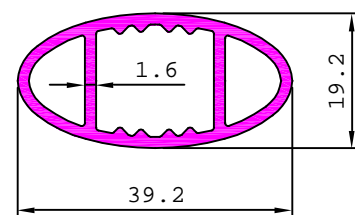

22521

1.251 kg/m

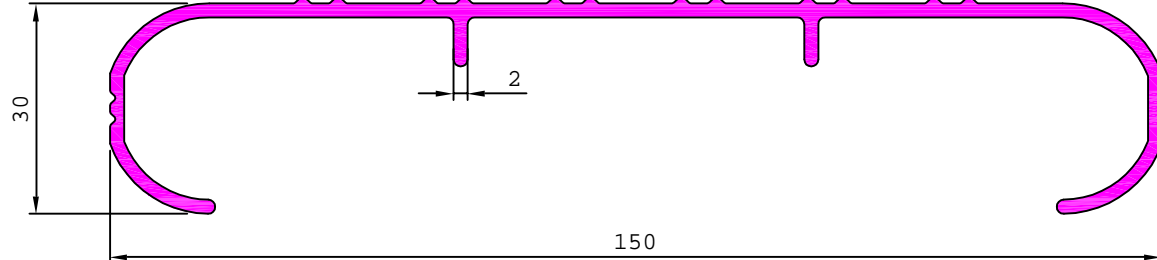

LADDERS

22523

1.099 kg/m

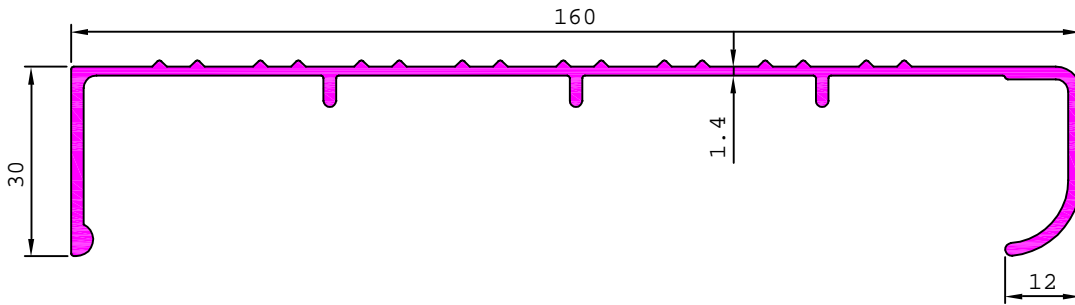

22524

0.668 kg/m

22525

0.486 kg/m

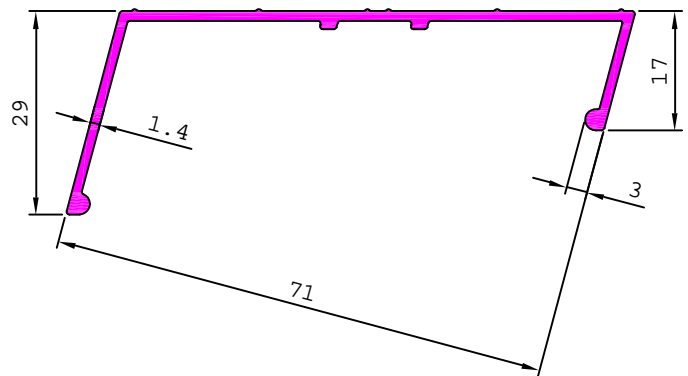
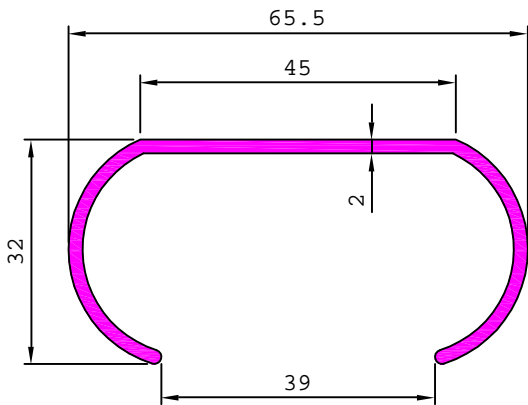

22526

0.506 kg/m

22546

0.371 kg/m

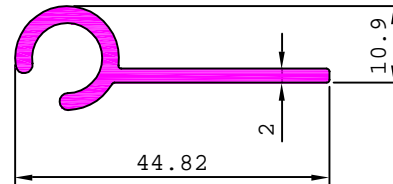
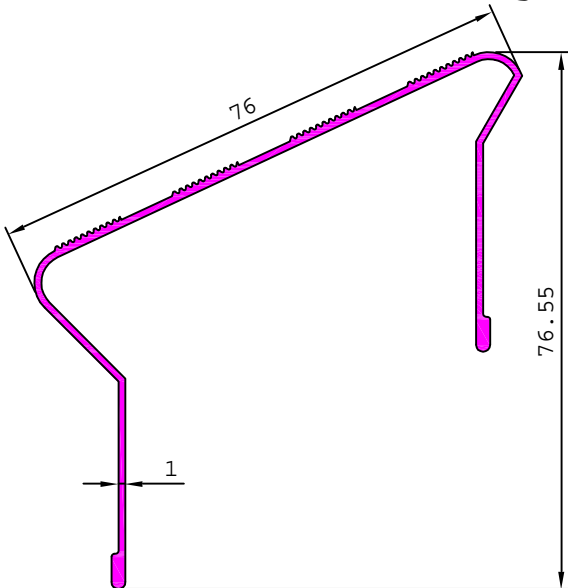

22545

0.197 kg/m

22547

0.875 kg/m

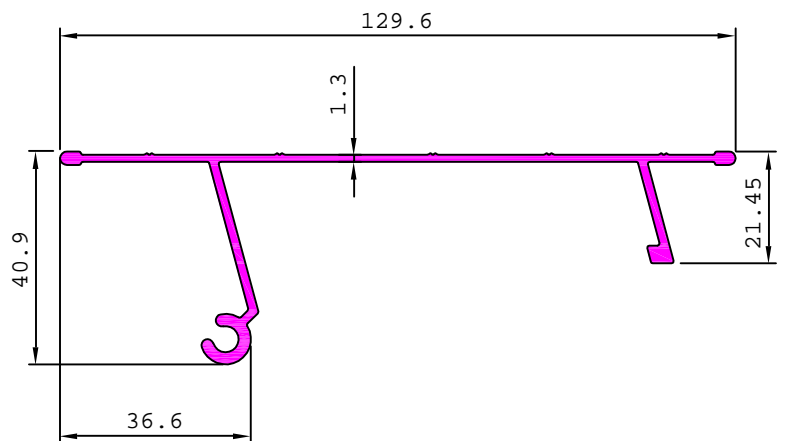
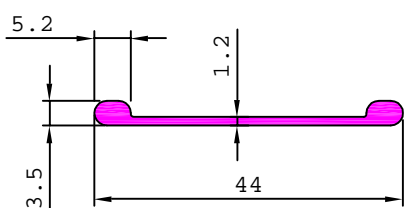

LADDERS

22548 0.355 kg/m

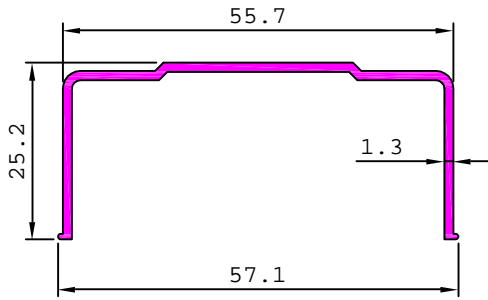

22550 1.296 kg/m

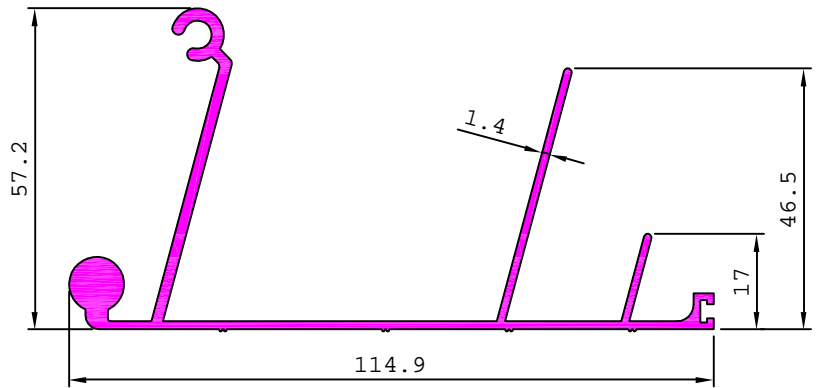

22549 0.360 kg/m

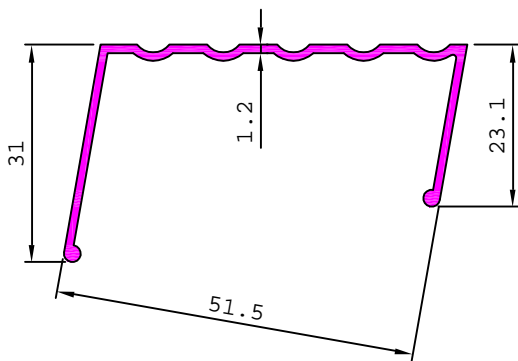

22551 1.103 kg/m

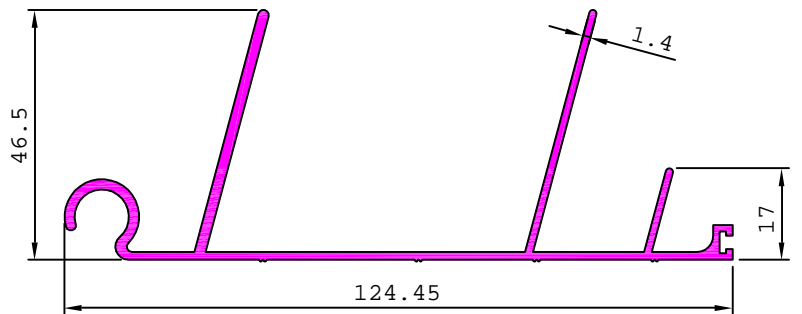

22553 0.287 kg/m

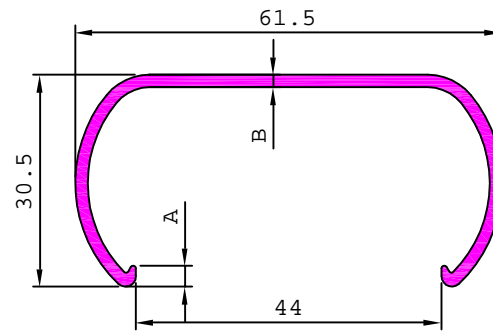
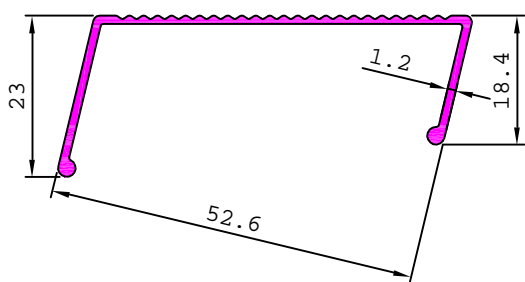

SL. No.	Section No.	A	B	Weight kg/m
1	22554	3.00	1.80	0.556
2	22555	3.50	2.80	0.836

22557 0.155 kg/m

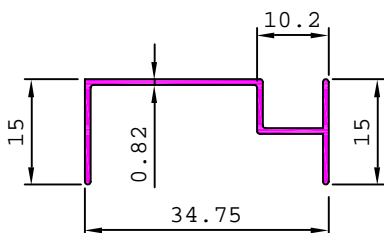

22556 0.335 kg/m

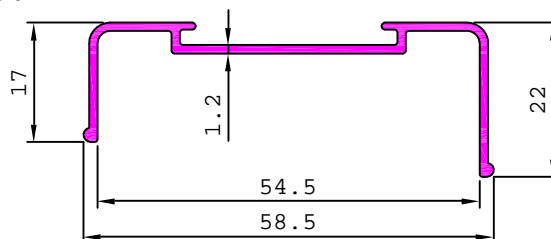

LADDERS

22558

0.777 kg/m

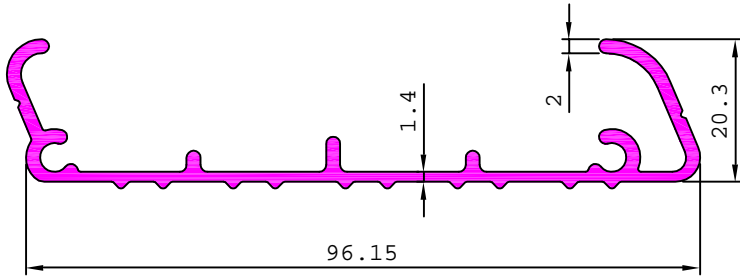

22559

0.345 kg/m

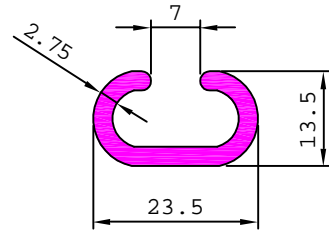

22560

3.266 kg/m

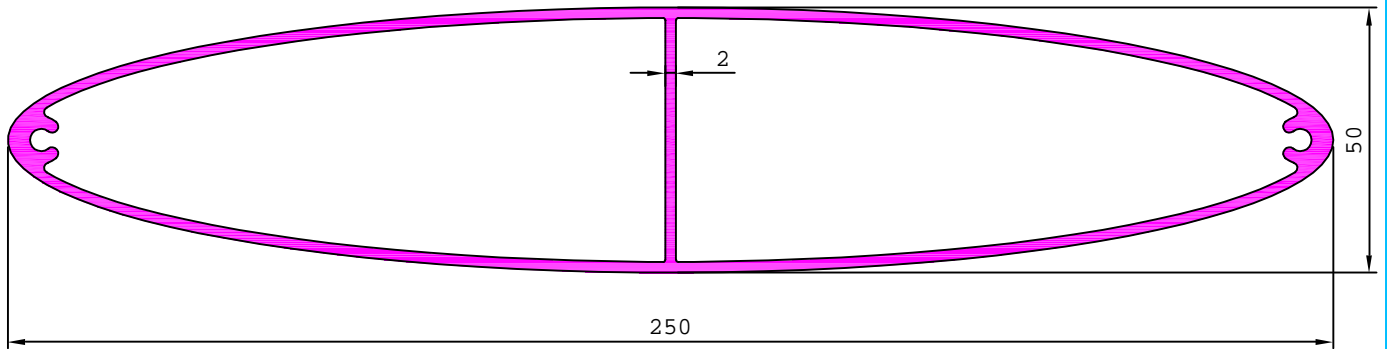

22561

0.362 kg/m

