

GLAZINGS

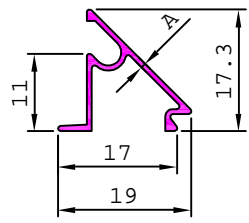

SL. No.	Section No.	A	Weight kg/m
1	19382	0.41	0.061
2	19366	0.49	0.071
3	19361	0.53	0.078
4	19352	0.70	0.097
5	19370	0.80	0.109
6	19360	0.90	0.124
7	19377	1.20	0.154

19354 0.213 kg/m

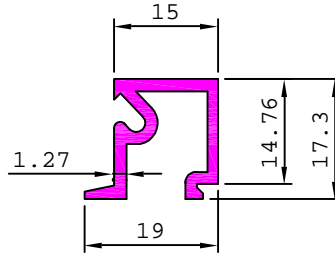

19358 0.243 kg/m

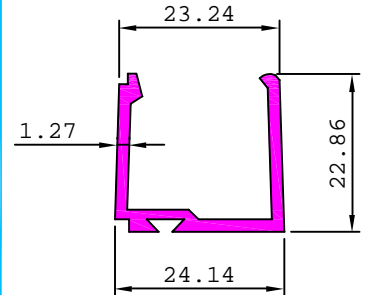

19359 0.301 kg/m

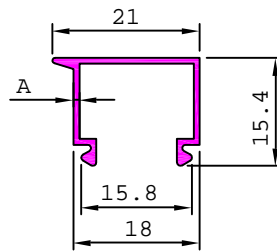
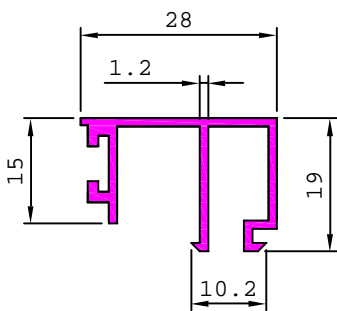

SL. No.	Section No.	A	Weight kg/m
1	19362	0.60	0.108
2	19369	0.85	0.137
3	19376	1.22	0.188

19363 0.229 kg/m

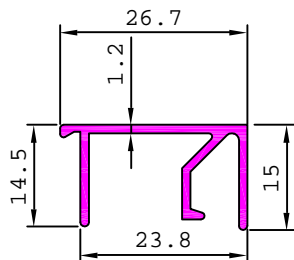

19364 0.209 kg/m

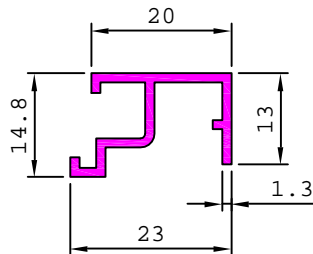

19365 0.182 kg/m

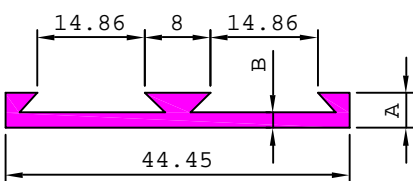
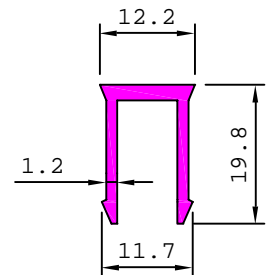

SL. No.	Section No.	A	B	Weight kg/m
1	19368	3.07	0.57	0.137
2	19367	3.27	0.77	0.161
3	19380	3.75	1.21	0.216
4	19353	5.72	3.18	0.453

19373 0.119 kg/m

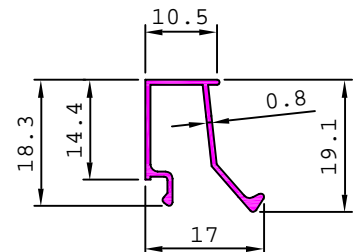

19371 0.471 kg/m

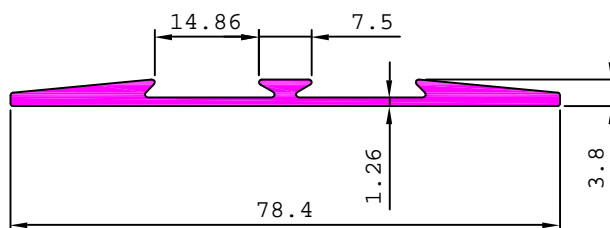

GLAZINGS

19374 0.161 kg/m

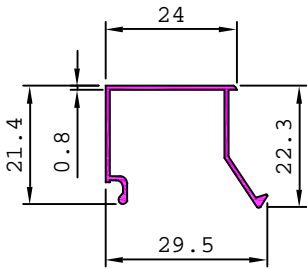

19375 0.175 kg/m

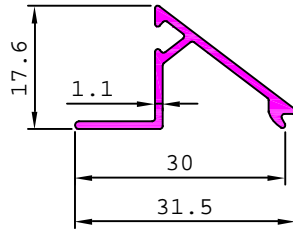

19378 0.156 kg/m

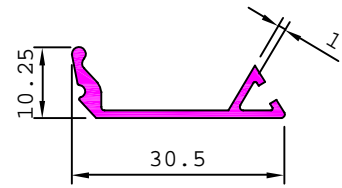

19379 0.119 kg/m

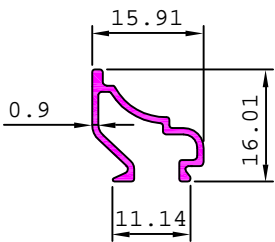

19381 0.373 kg/m

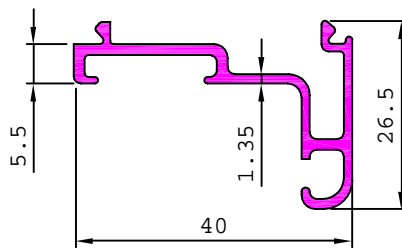

19383 0.248 kg/m

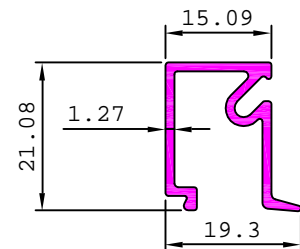

19384 0.424kg/m

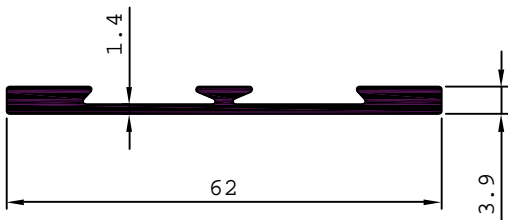

19385 0.216 kg/m

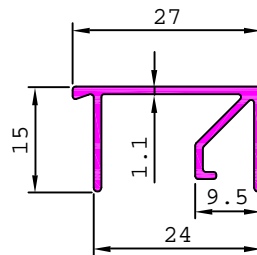

19386 0.208 kg/m

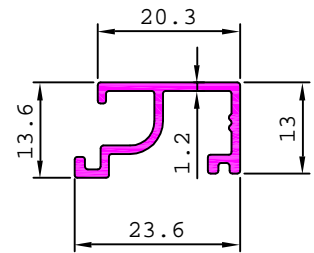

19387 0.349 kg/m

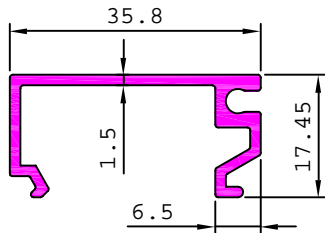

19388 0.200 kg/m

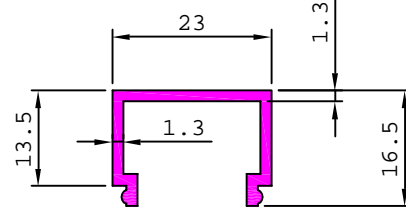

19389 0.157 kg/m

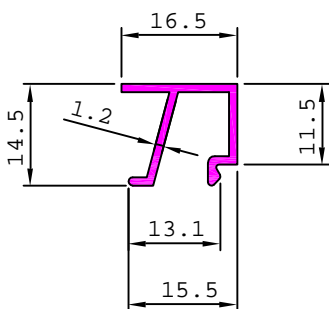

19390 0.259 kg/m

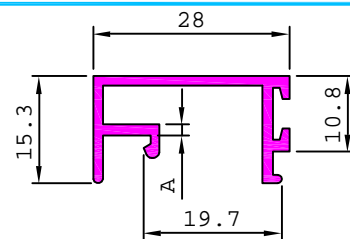
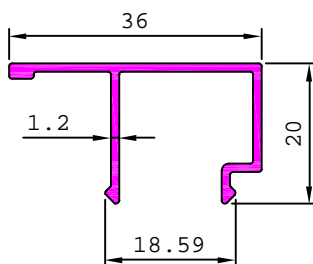

SL. No.	Section No.	A	Weight kg/m
1	19392	1.11	0.224
2	19391	1.50	0.289

GLAZINGS

19393 0.164 kg/m

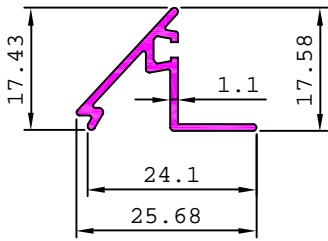

19394 0.380 kg/m

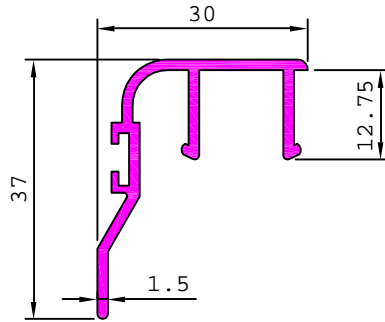

19395 0.405 kg/m

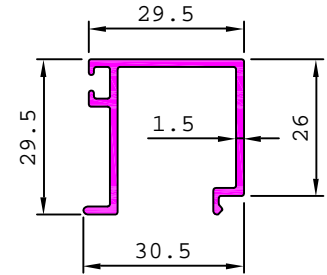

19396 0.268 kg/m

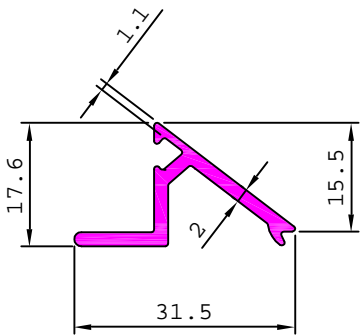

19397 0.200 kg/m

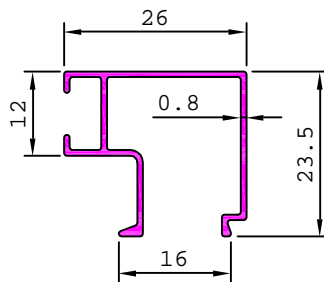

19398 0.174 kg/m

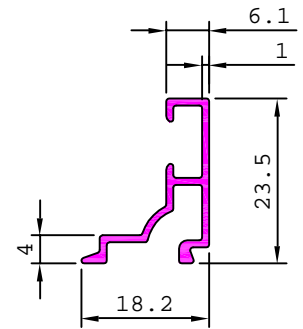

19400 0.200 kg/m

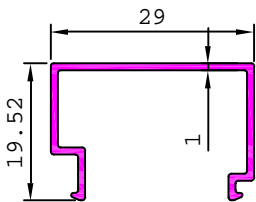

19401 0.457 kg/m

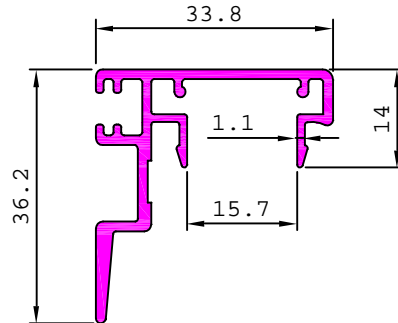

19402 0.313 kg/m

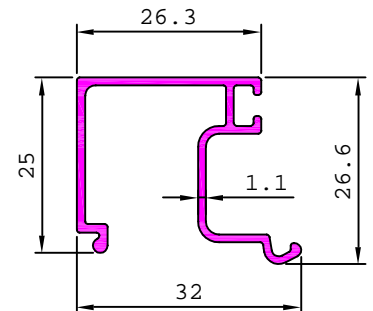

19403 0.288 kg/m

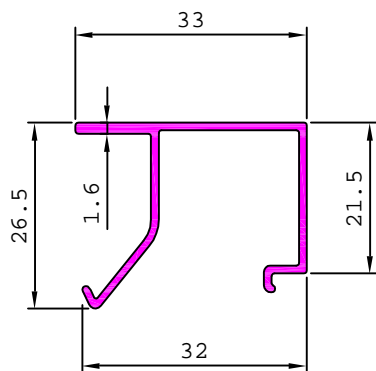

19404 0.226 kg/m

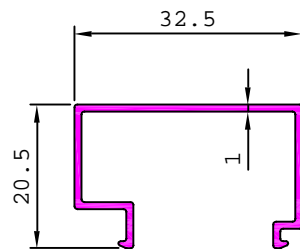

19405 0.164 kg/m

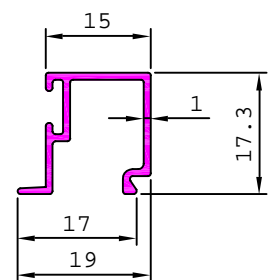

GLAZINGS

19406 0.219 kg/m

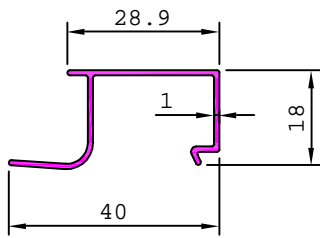

19407 0.260 kg/m

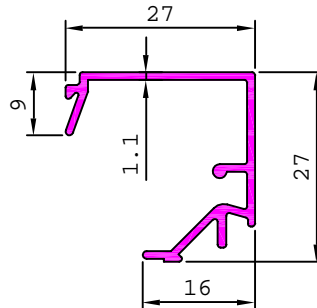

19408 0.267 kg/m

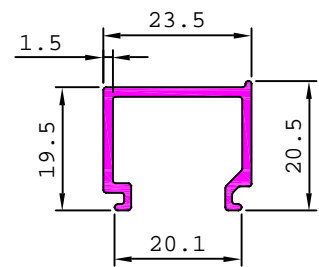

19409 0.237 kg/m

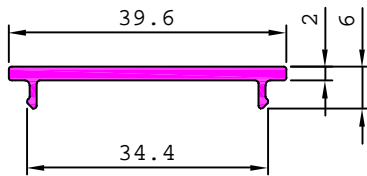

19410 0.302 kg/m

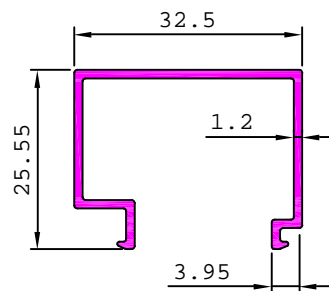

19411 0.437 kg/m

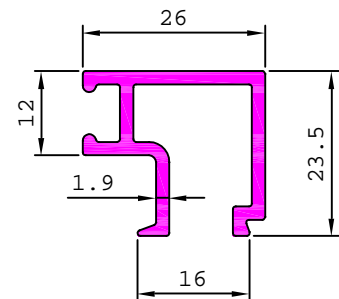

19412 0.248 kg/m

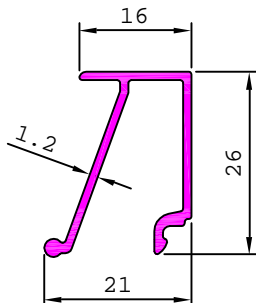

19413 0.270 kg/m

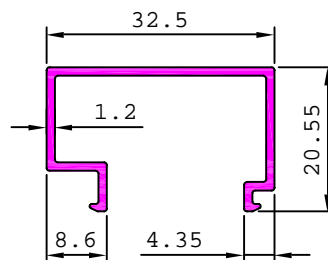

S1893 0.208 kg/m

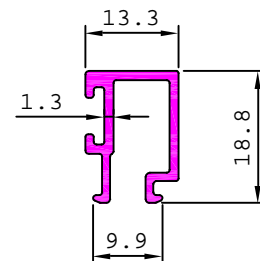

S2016 0.116 kg/m

