

## MISCELLANEOUS

24435 0.461 kg/m

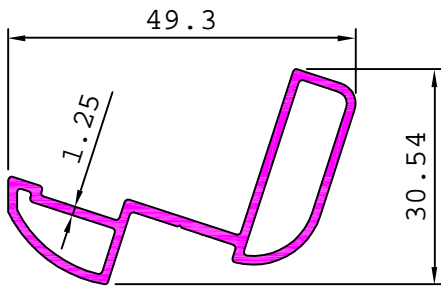

24436 0.410 kg/m

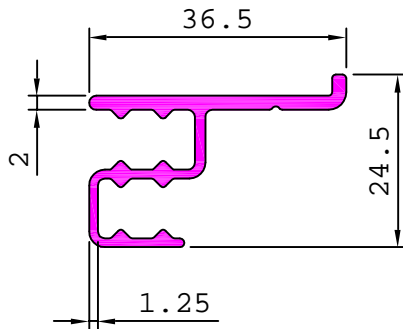

24440 1.307 kg/m

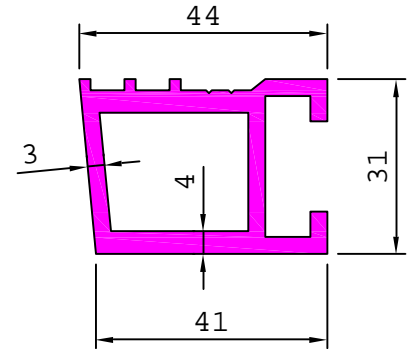

24437

1.505 kg/m

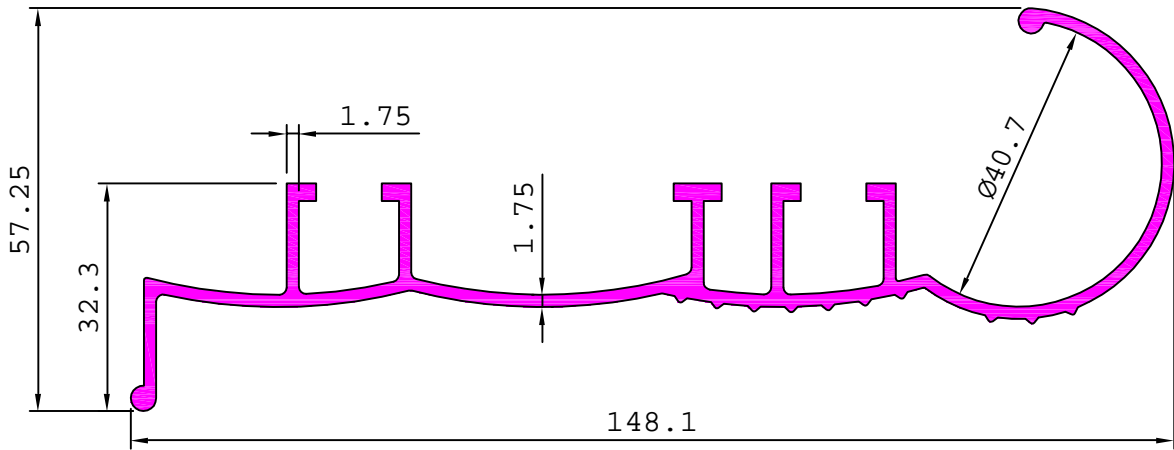

24441 0.267 kg/m

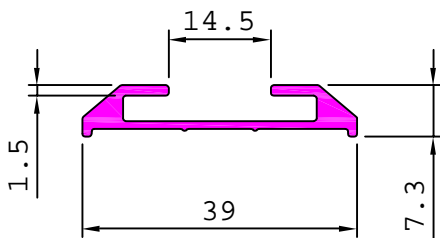

24443 1.905 kg/m

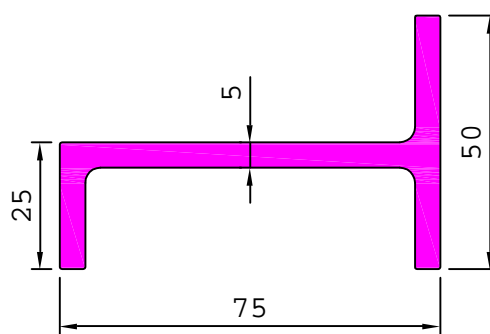

24444 1.078 kg/m

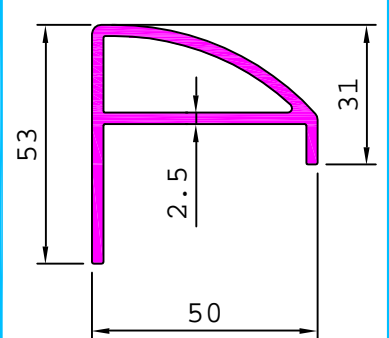

24445

2.694 kg/m

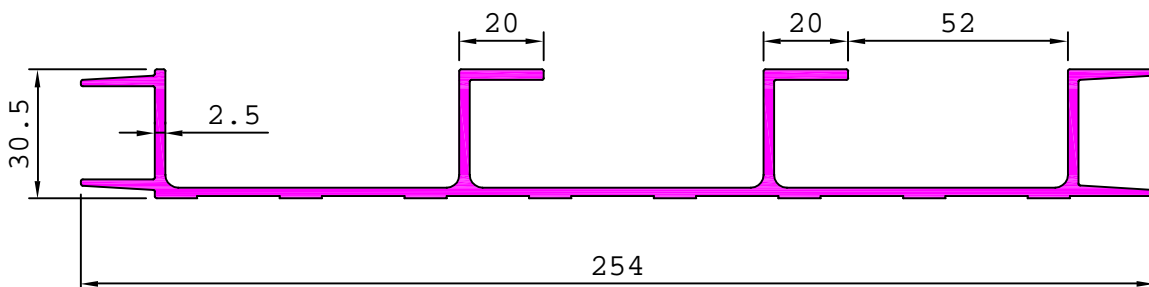

MISCELLANEOUS

24446

2.335 kg/m

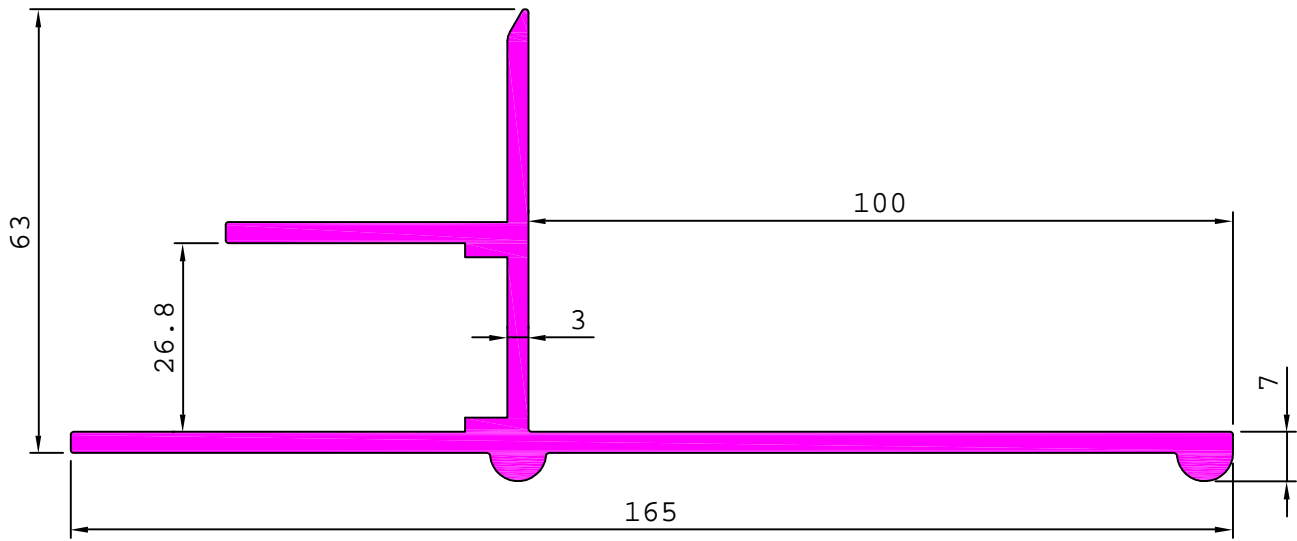

24442

0.466 kg/m

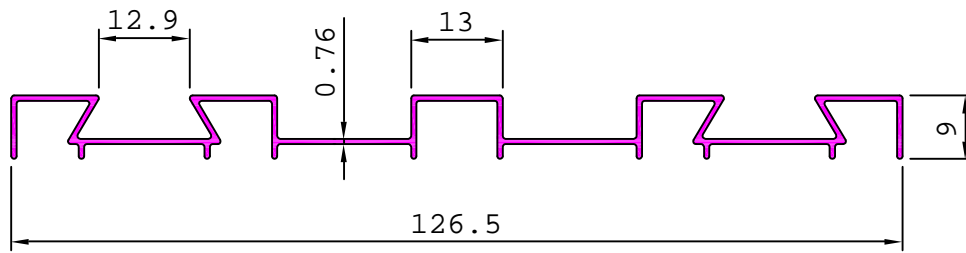

SL. No.	Section No.	A	B	Weight kg/m
1	24448	151.39	1.80	1.148
2	24450	151.50	2.00	1.447

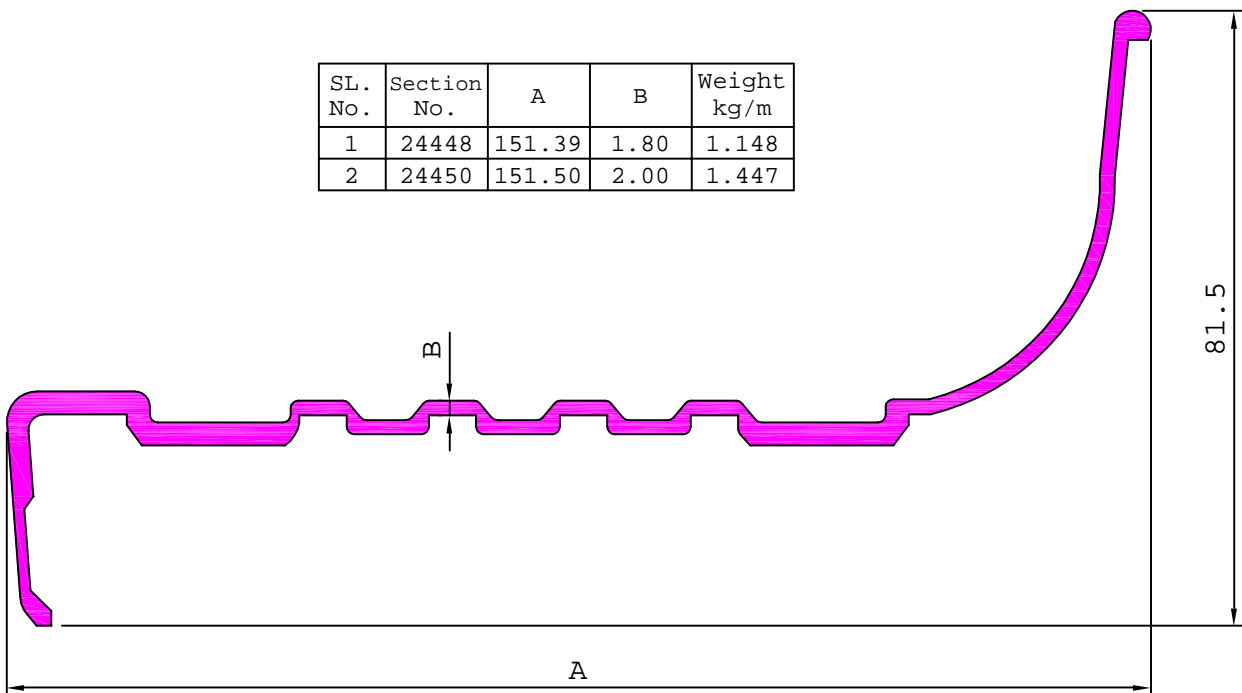

## MISCELLANEOUS

24447

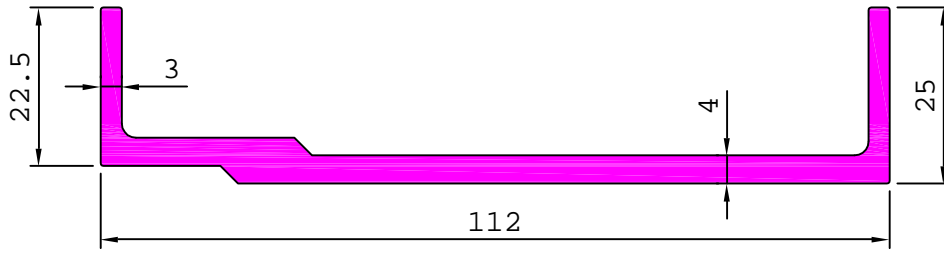

1.605 kg/m

24451

2.394 kg/m

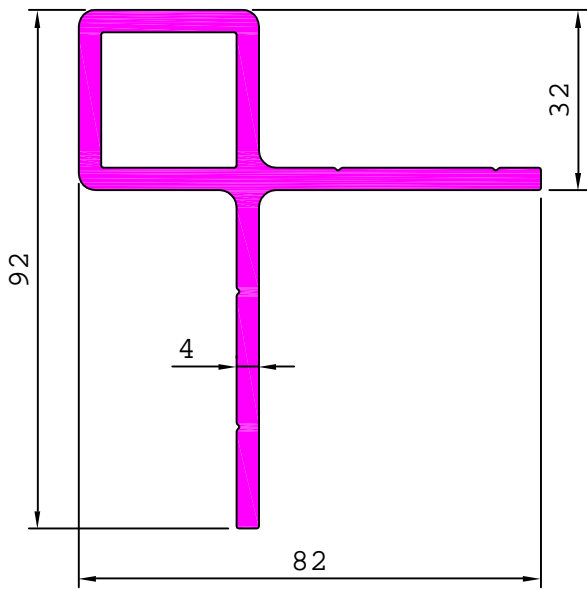

24452

1.031 kg/m

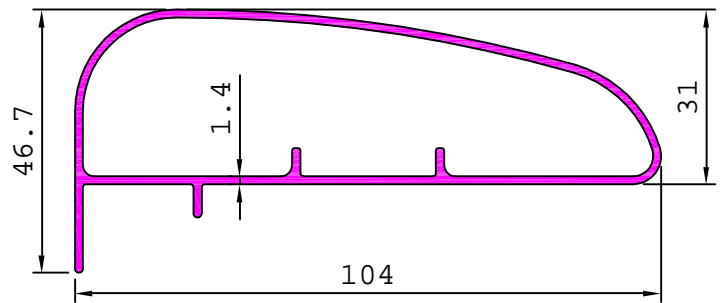

24453

0.322 kg/m

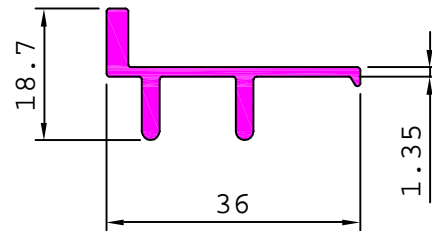

24455

0.258 kg/m

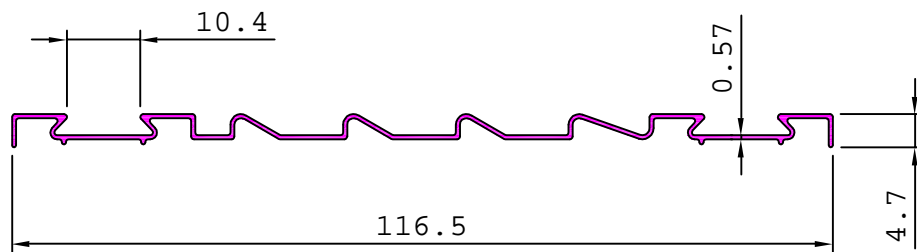

24457

0.157 kg/m

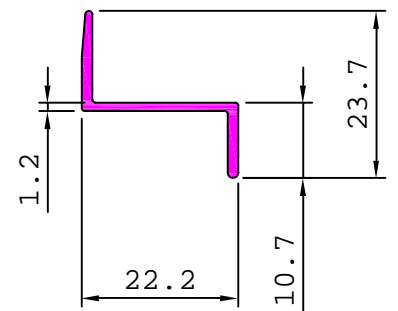

24456

0.382 kg/m

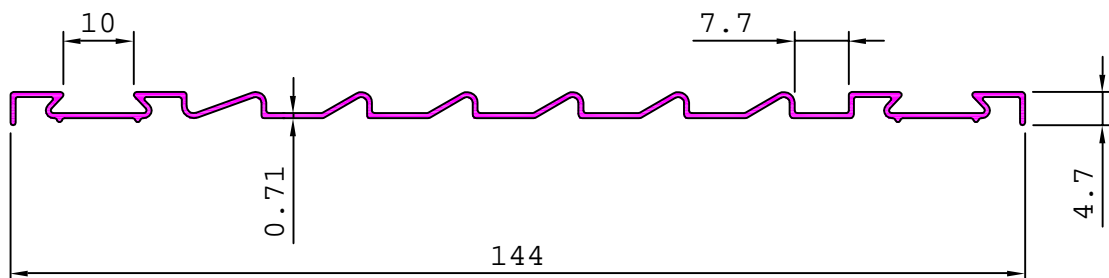

## MISCELLANEOUS

24458 0.171 kg/m

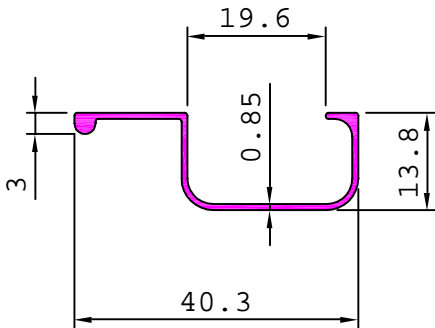

24459 1.544 kg/m

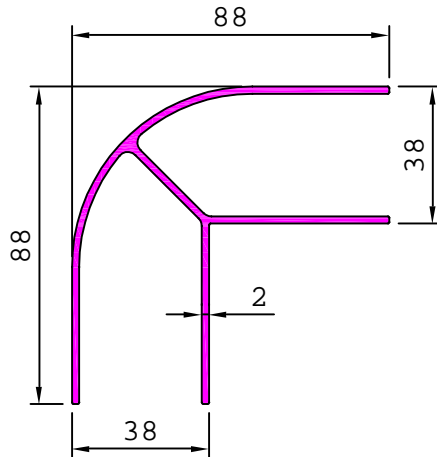

24461 0.321 kg/m

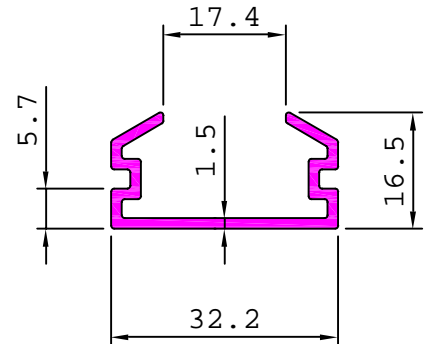

24460

1.969 kg/m

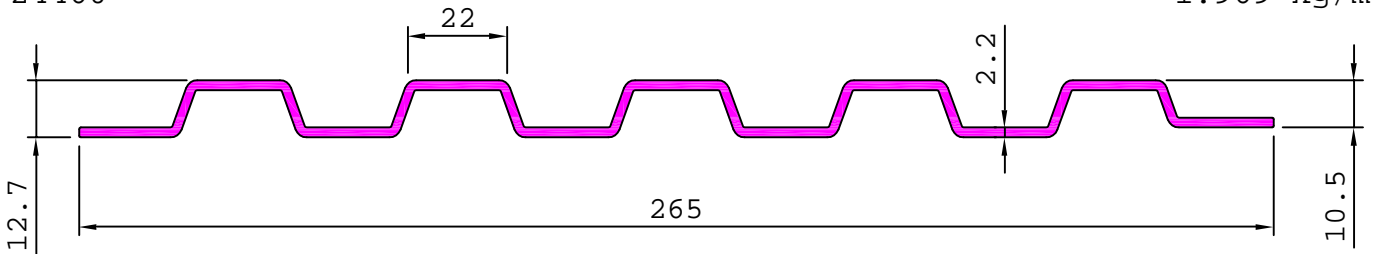

24462 0.460 kg/m

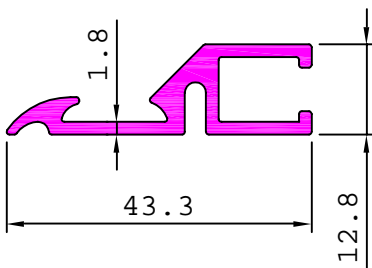

24464 0.477 kg/m

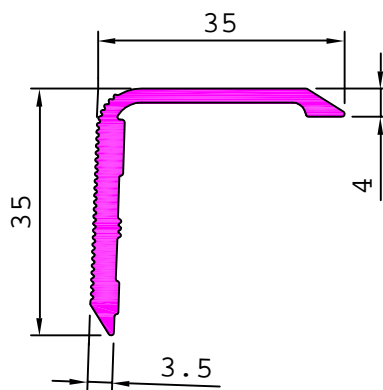

24465 1.062 kg/m

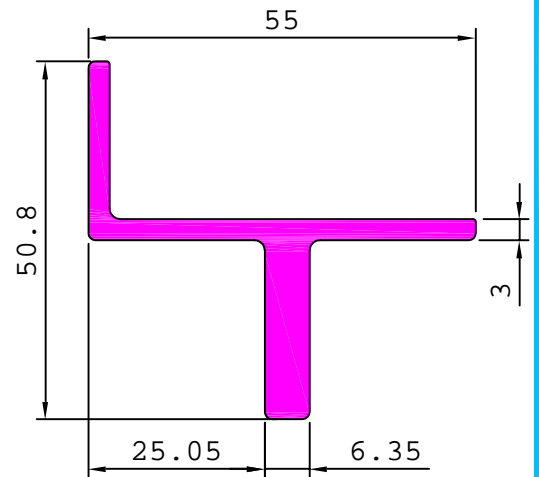

24463

2.190 kg/m

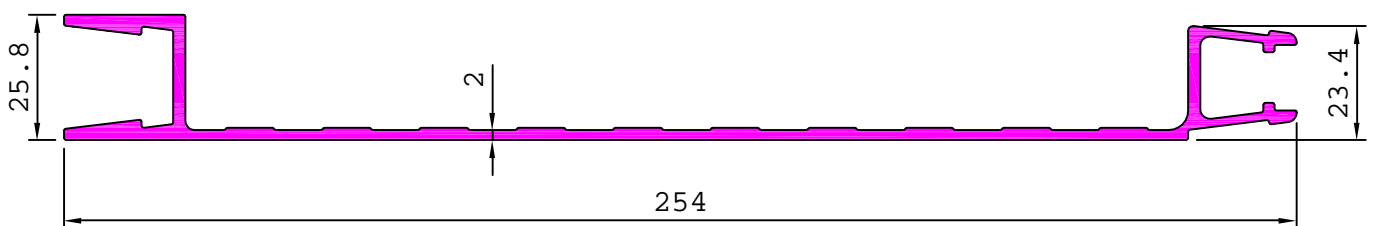

## MISCELLANEOUS

24466

1.115 kg/m

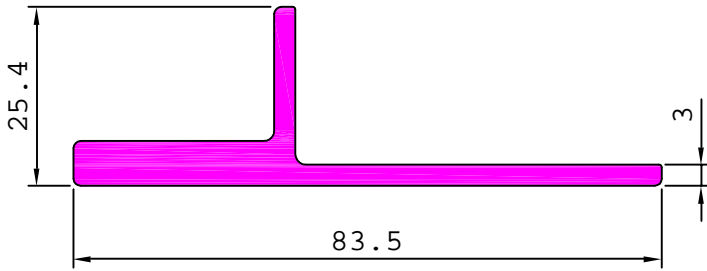

24467

1.134 kg/m

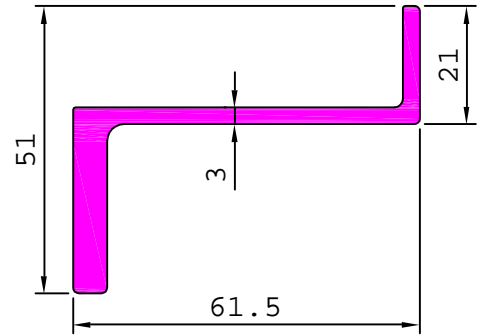

24468

1.004 kg/m

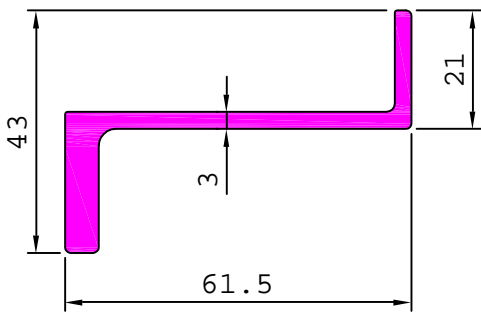

24469

0.626 kg/m

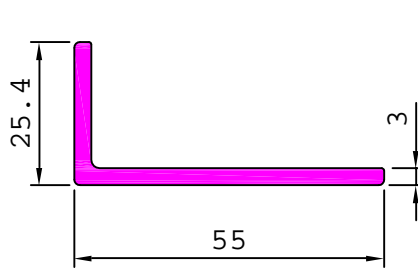

24471

0.505 kg/m

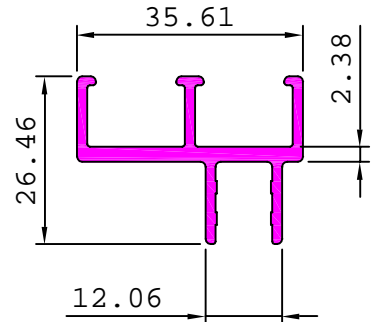

24473

2.834 kg/m

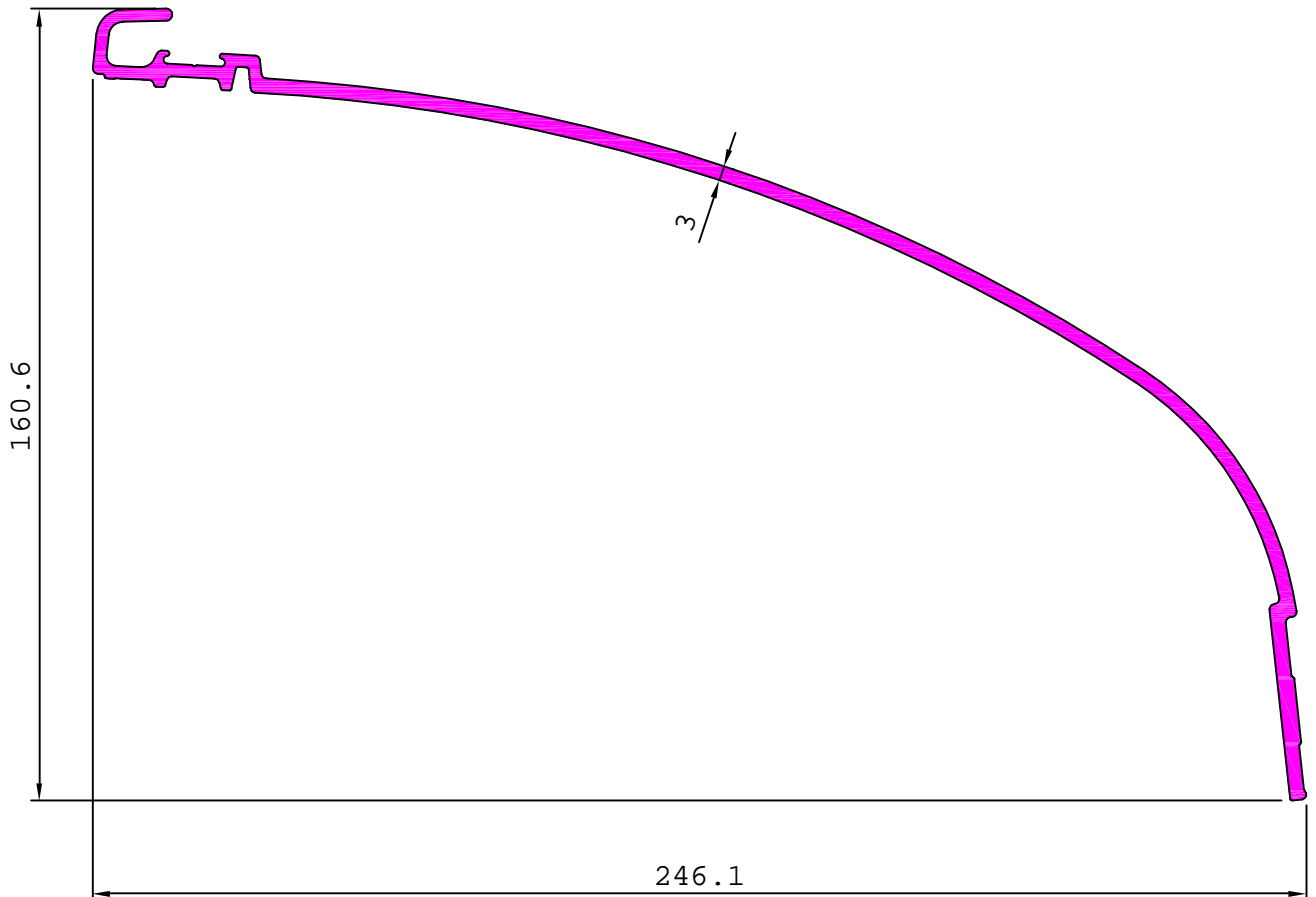

## MISCELLANEOUS

24470

5.020 kg/m

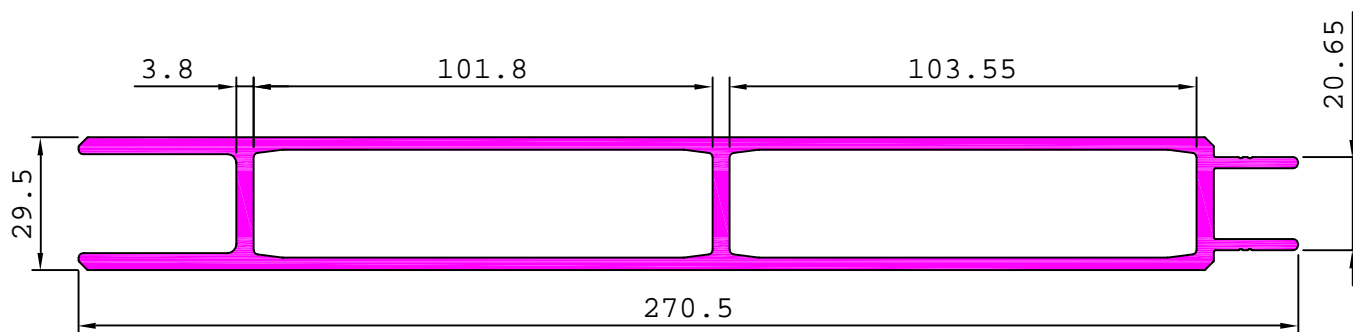

24472

1.661 kg/m

