

BUS WINDOW GUIDE FRAMES

24202 0.310 kg/m

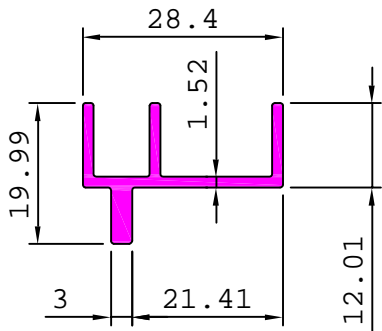

24204 0.247 kg/m

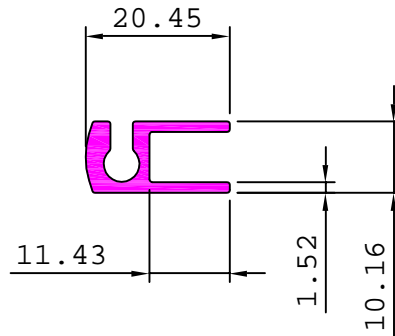

24205 0.279 kg/m

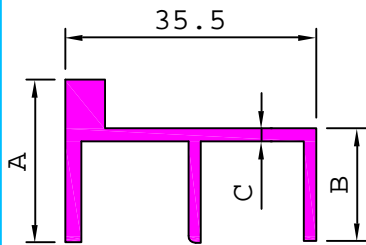
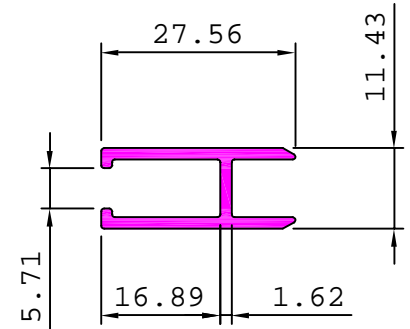

SL. No.	Section No.	A	B	C	Weight kg/m
1	24218	22.60	15.70	1.85	0.464
2	24206	23.00	16.00	1.13	0.333

24210 0.269 kg/m

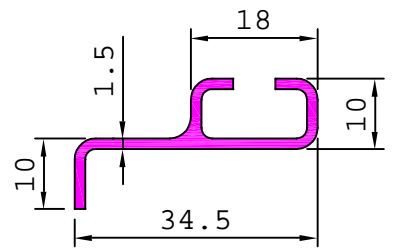

24211 0.148 kg/m

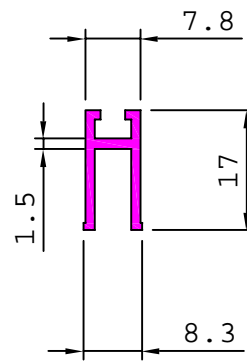

24212 0.168 kg/m

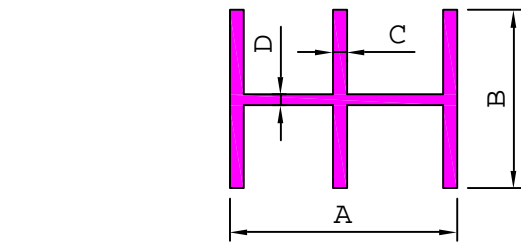
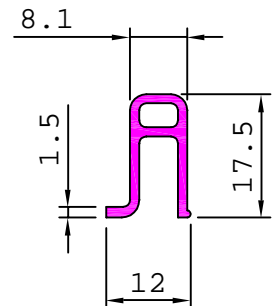

SL. No.	Section No.	A	B	C	D	Weight kg/m
1	24207	35.50	28.00	1.80	1.00	0.489
2	24234	35.80	31.00	1.80	1.80	0.600
3	24215	36.20	30.60	0.97	0.97	0.328

24208 0.592 kg/m

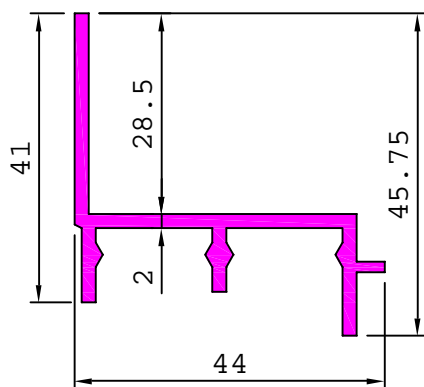

24209 0.328 kg/m

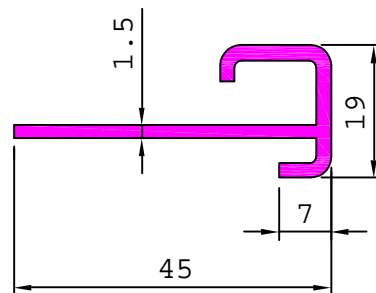

24217 0.407 kg/m

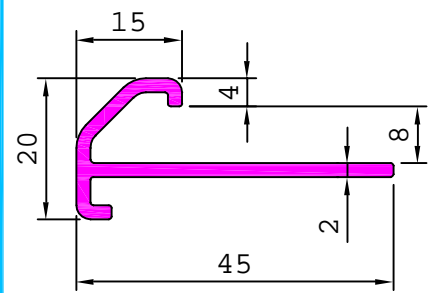

BUS WINDOW GUIDE FRAMES

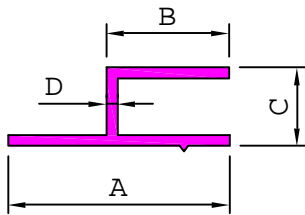

SL. No.	Section No.	A	B	C	D	Weight kg/m
1	24235	29.90	18.00	12.30	0.70	0.112
2	24213	31.00	16.50	11.00	0.84	0.130
3	24214	34.60	19.50	12.70	0.93	0.166

24219 0.243 kg/m

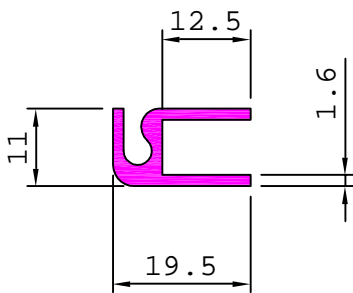

24220 0.687 kg/m

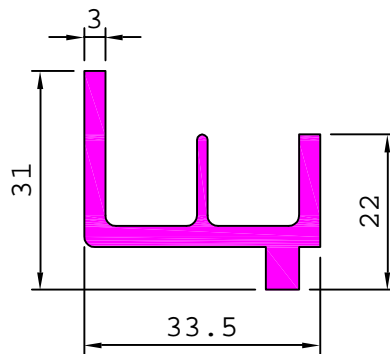

24221 0.662 kg/m

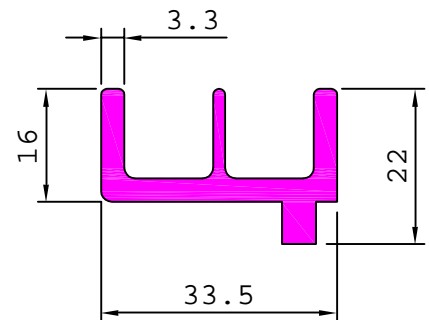

24222 0.910 kg/m

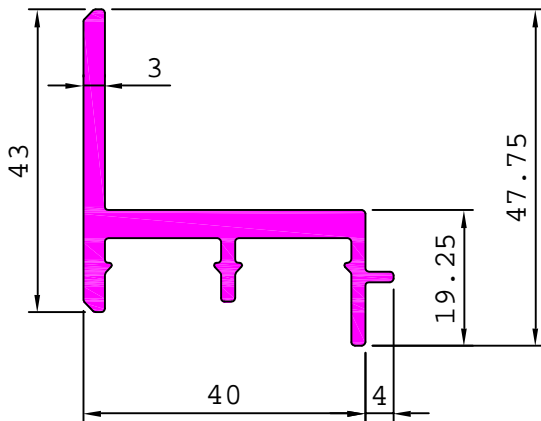

24223 0.478 kg/m

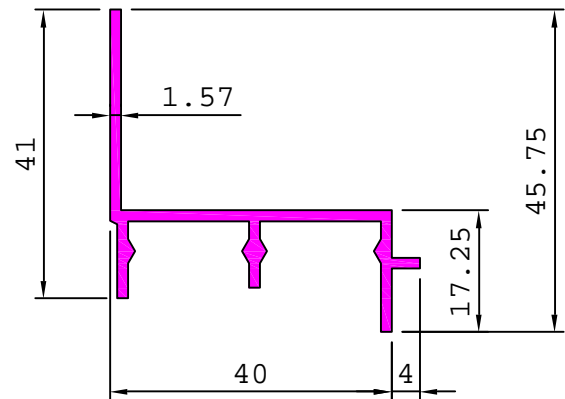

24226 0.686 kg/m

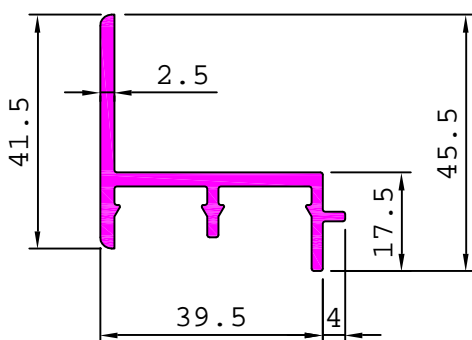

24227 0.669 kg/m

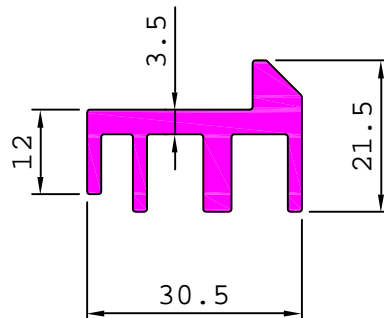

24228 0.680 kg/m

