

## ELECTRONICS

25703 0.308 kg/m

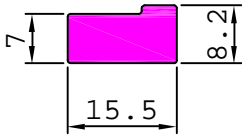

25705 2.286 kg/m

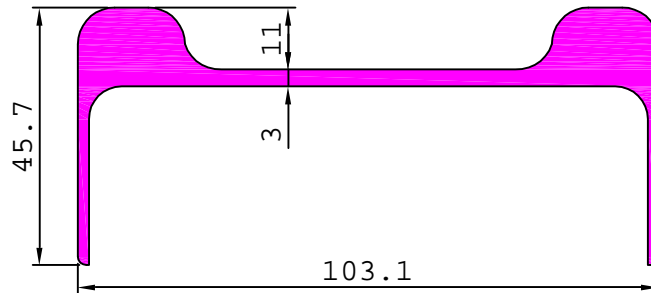

25707 0.111 kg/m

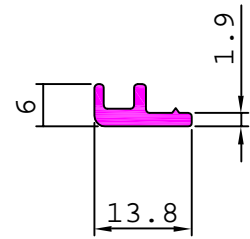

25708 0.353 kg/m

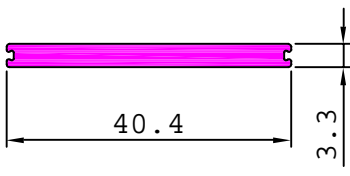

25711 0.293 kg/m

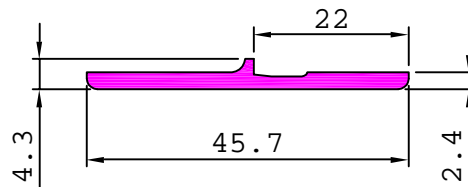

25714 0.509 kg/m

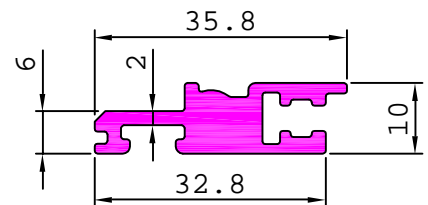

25713 1.653 kg/m

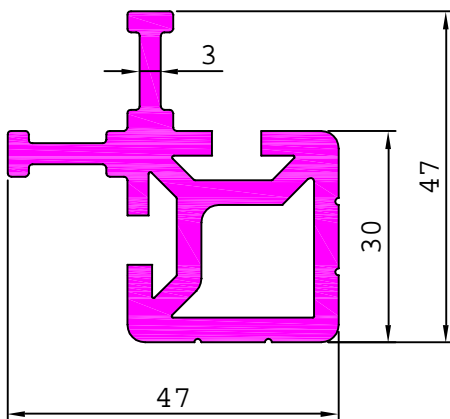

25715 0.610 kg/m

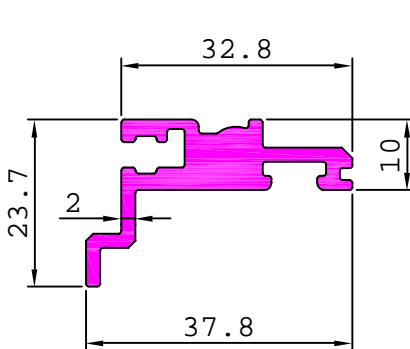

25716 1.122 kg/m

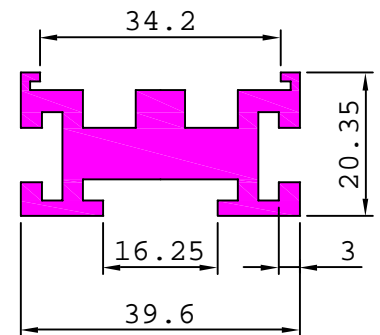

25717 1.316 kg/m

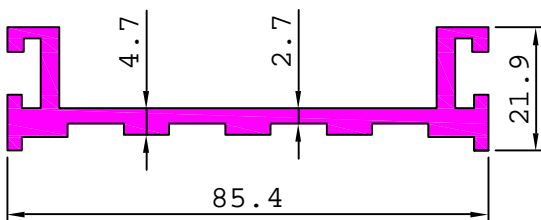

25718 0.604 kg/m

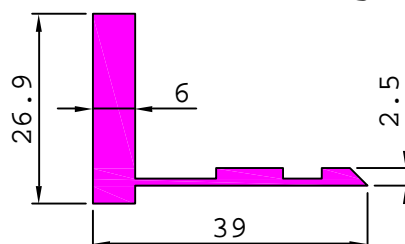

25720 0.468 kg/m

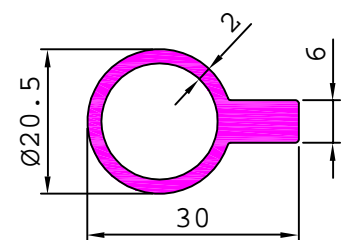

25723 0.350 kg/m

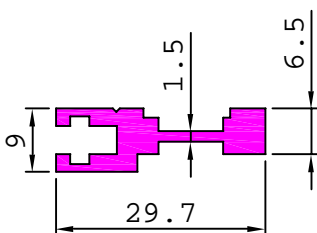

25724 0.273 kg/m

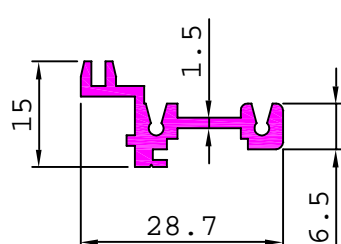

25726 1.041 kg/m

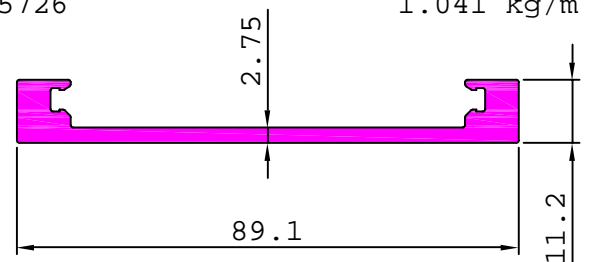

## ELECTRONICS

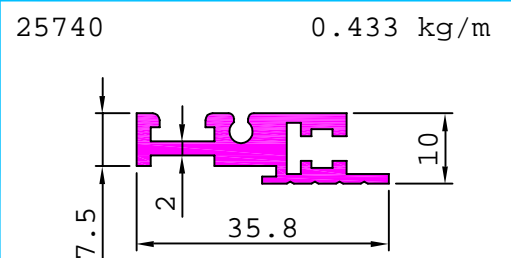
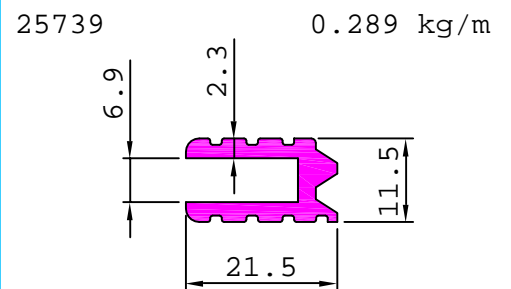
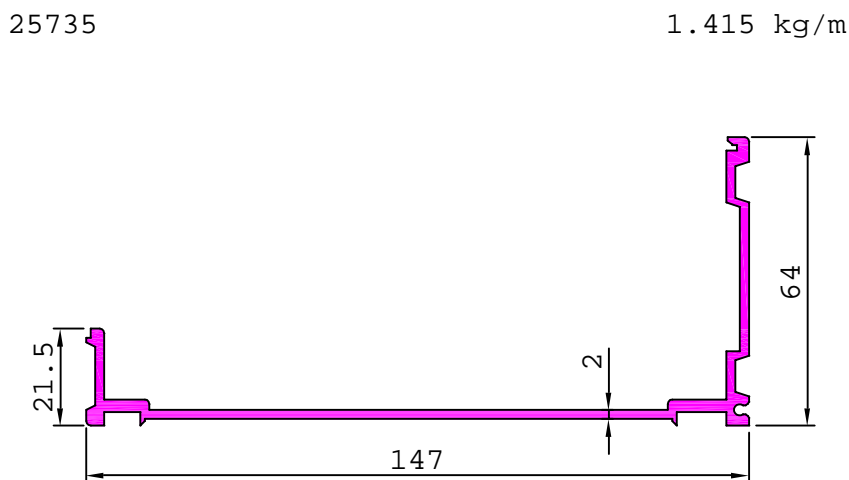
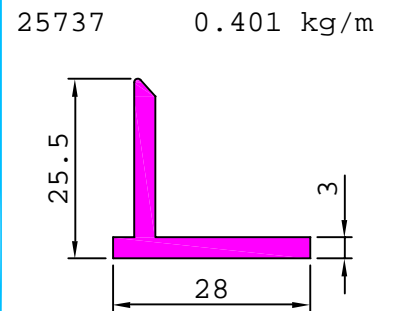
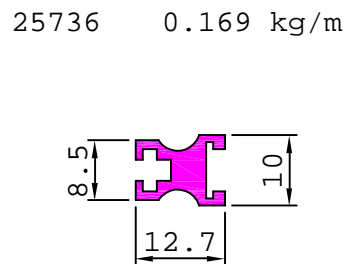
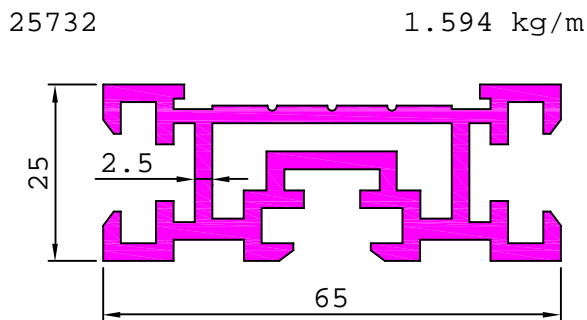
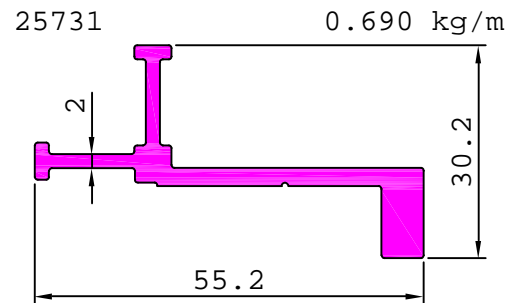
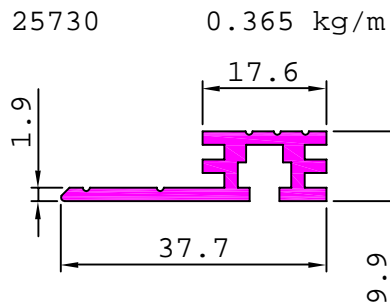
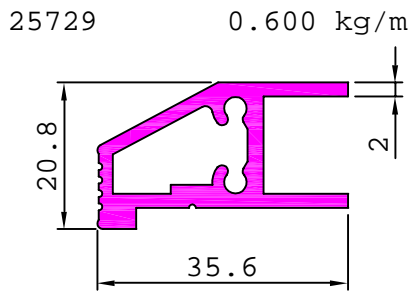
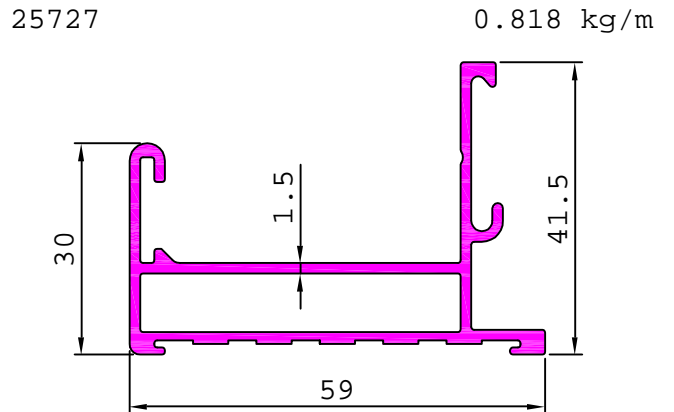
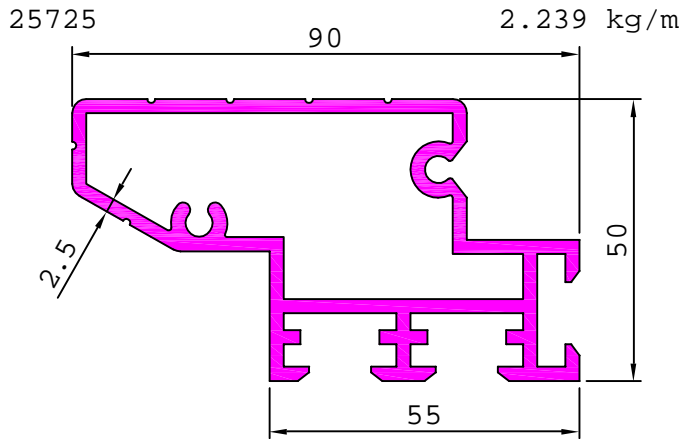

## ELECTRONICS

25741 0.073 kg/m

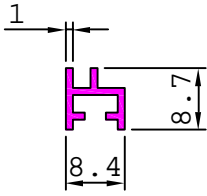

25742 0.531 kg/m

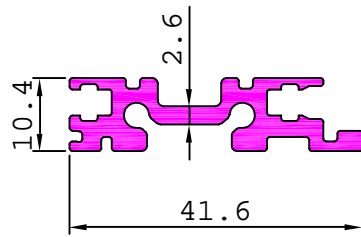

25745 0.600 kg/m

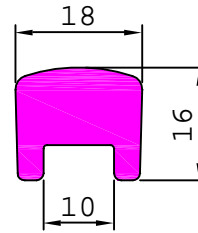

25746 0.282 kg/m

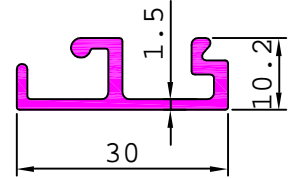

25747 0.813 kg/m

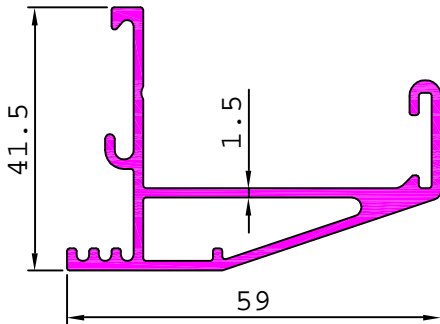

25748 1.387 kg/m

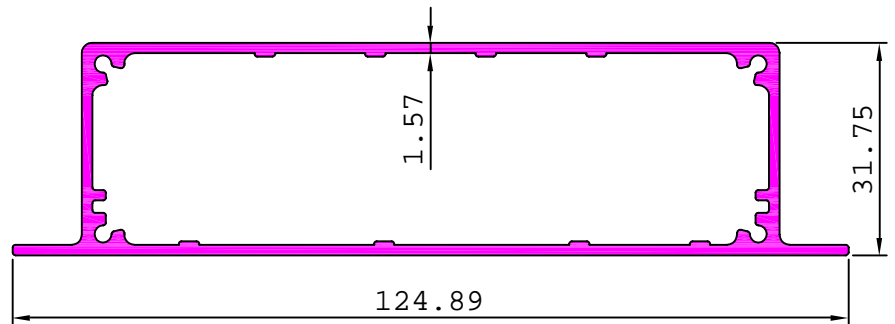

25749 2.533 kg/m

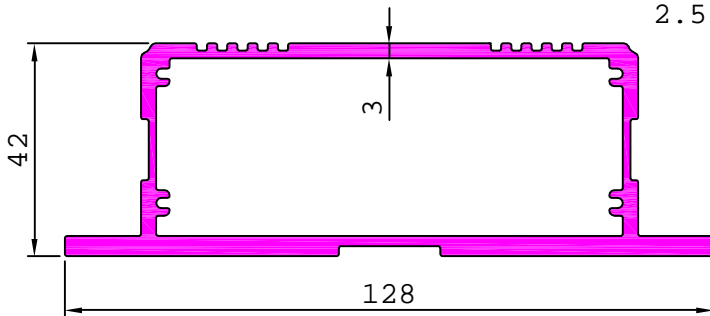

25750 0.373 kg/m

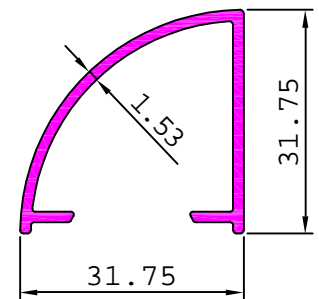

25751 0.218 kg/m

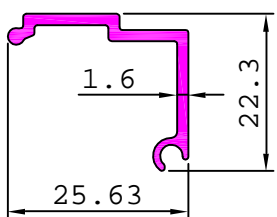

25752 0.178 kg/m

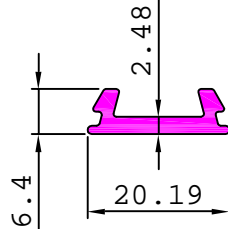

25754 2.178 kg/m

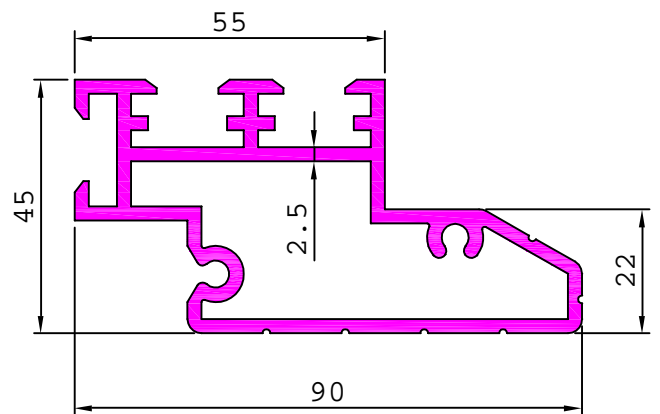

25753 0.437 kg/m

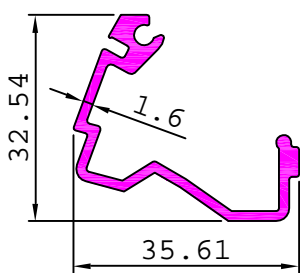

25755 0.353 kg/m

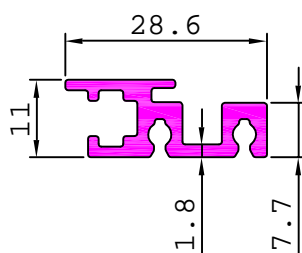

## ELECTRONICS

25756

0.602 kg/m

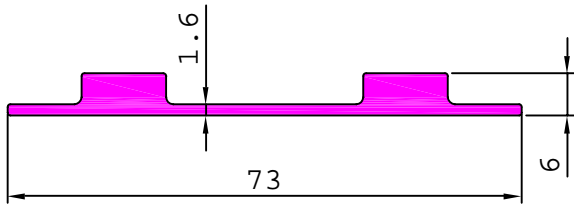

25757

0.233 kg/m

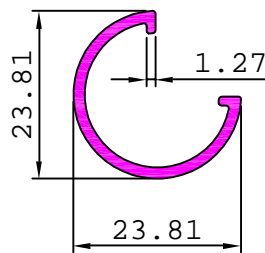

25758

0.116 kg/m

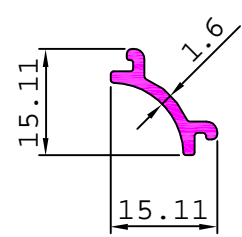

25759

0.617 kg/m

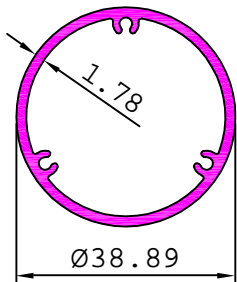

25760

0.634 kg/m

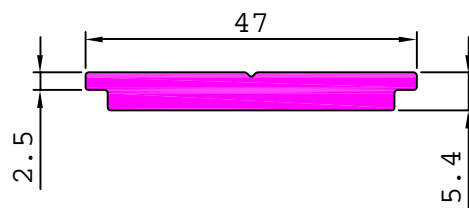

25762

0.352 kg/m

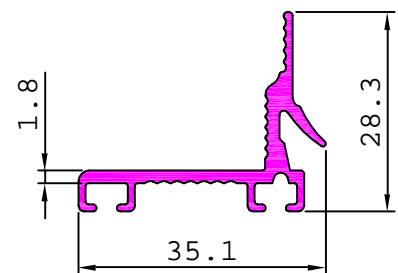

25761

3.489 kg/m

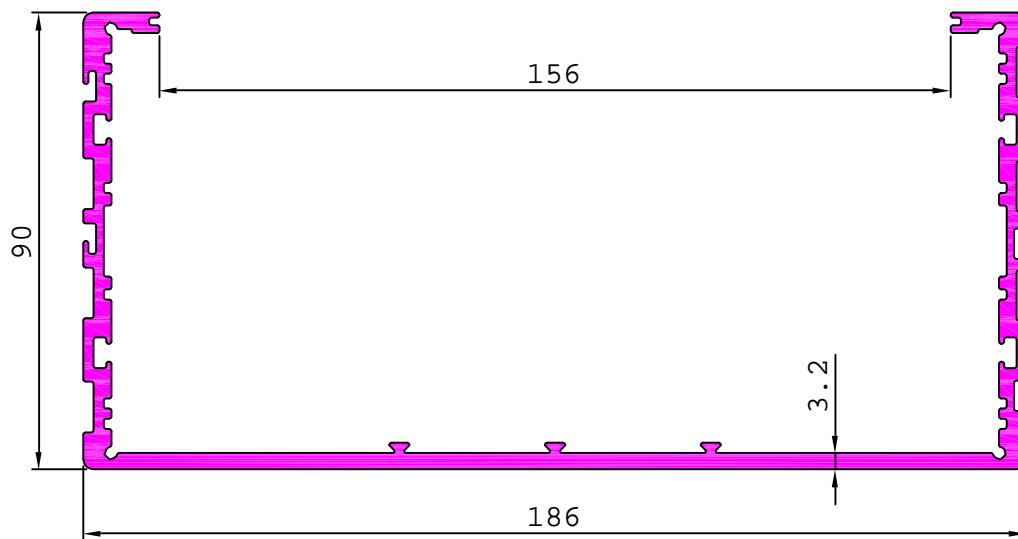

25763

0.979 kg/m

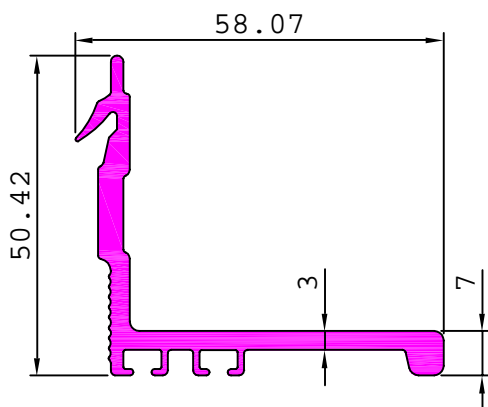

25764

0.376 kg/m

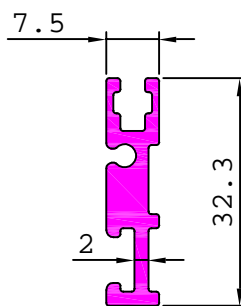

25765

2.438 kg/m

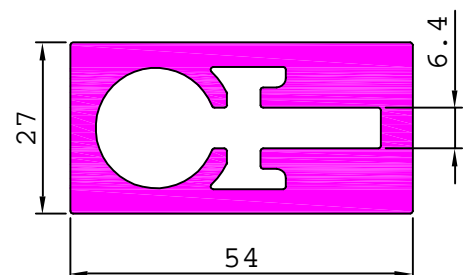

ELECTRONICS

25766

2.261 kg/m

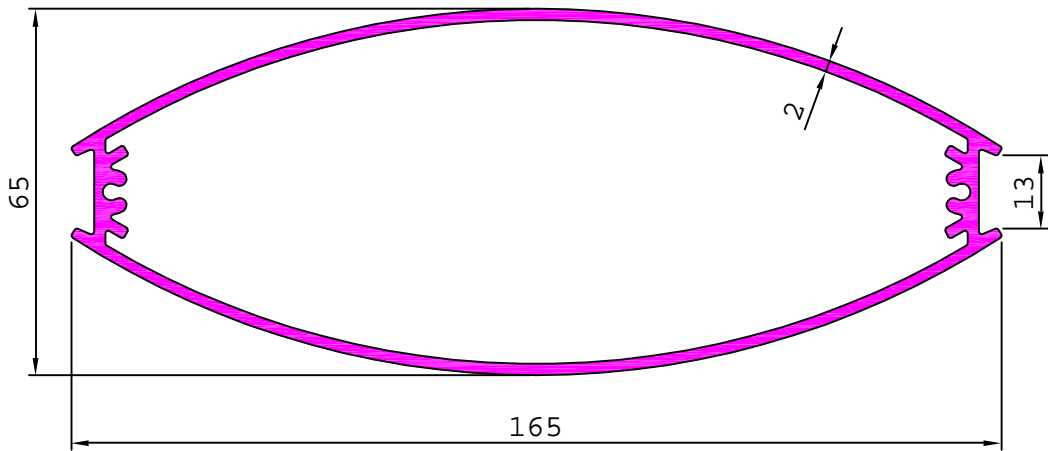

S1963

2.304 kg/m

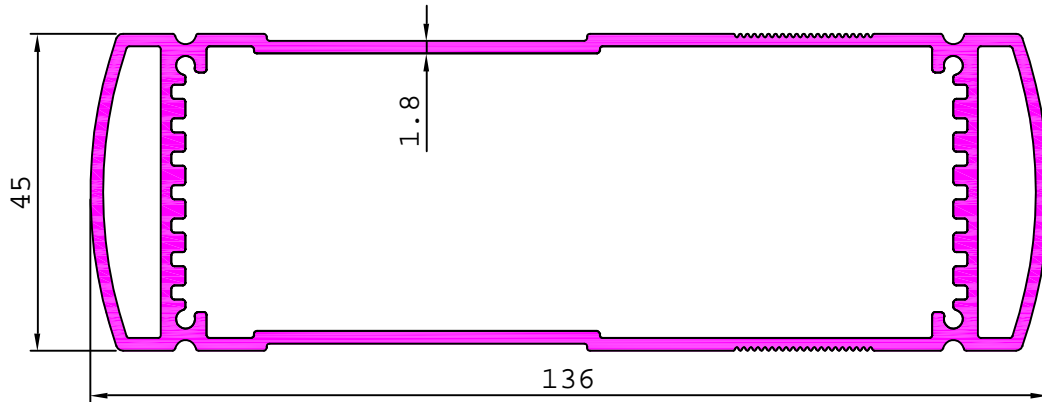

S2064

2.321 kg/m

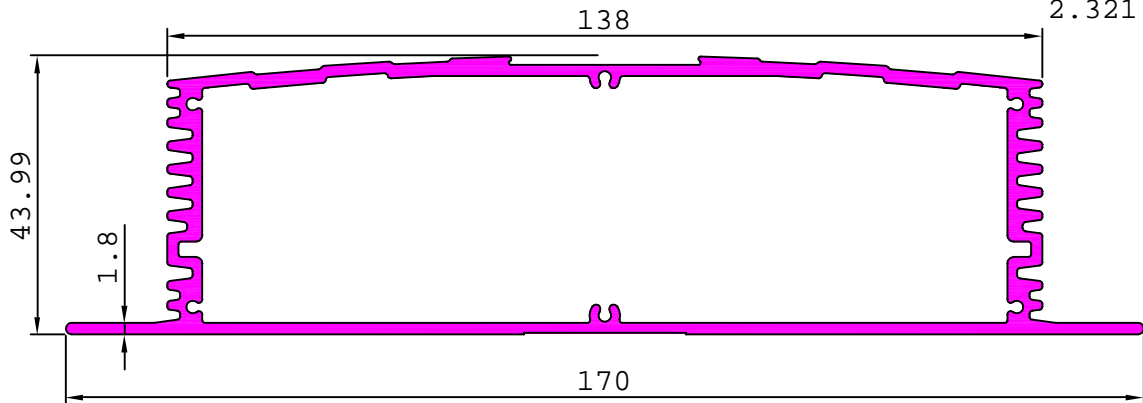

S1749

0.781 kg/m

