

ELECTRICALS

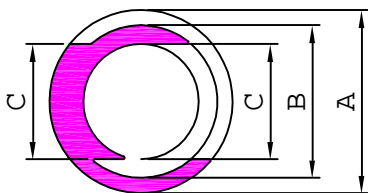

SL. No.	Section No.	A	B	C	Weight kg/m
1	25056	52.00	43.00	33.00	1.709
2	25067	54.00	45.00	34.00	1.862

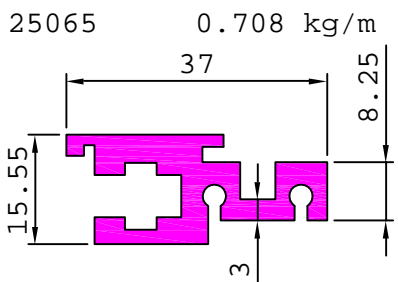
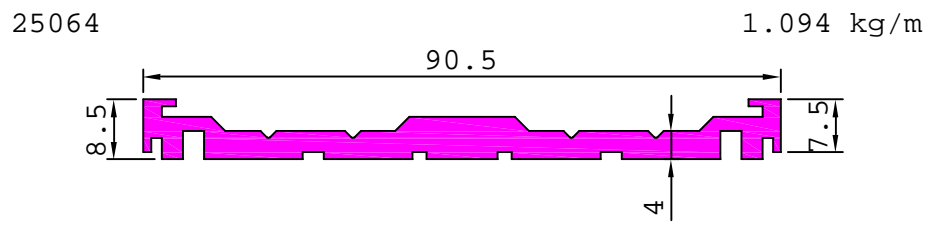
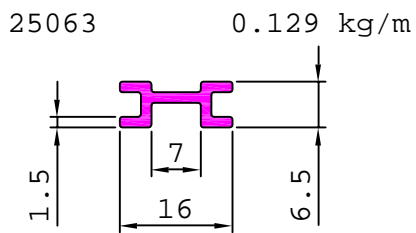
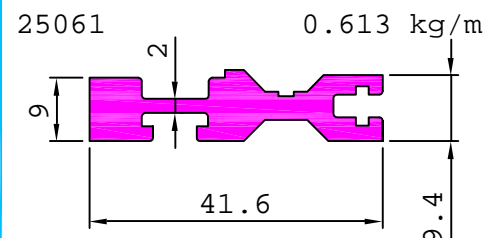
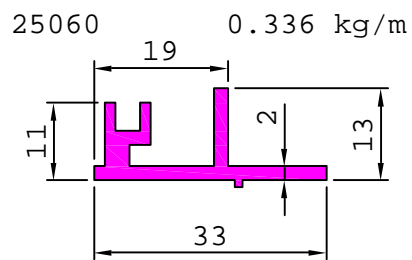
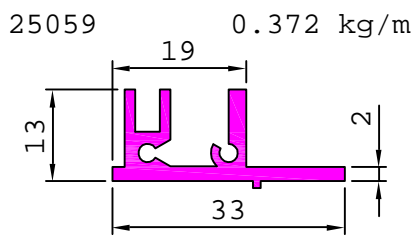
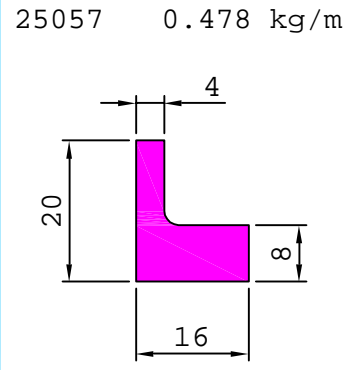
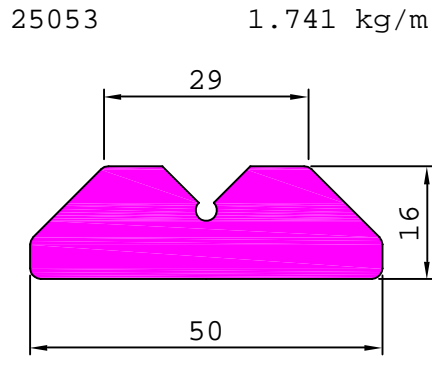
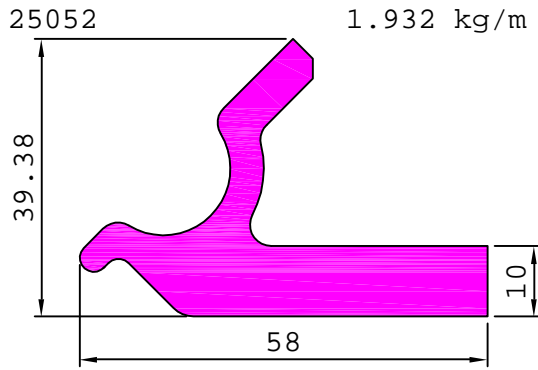
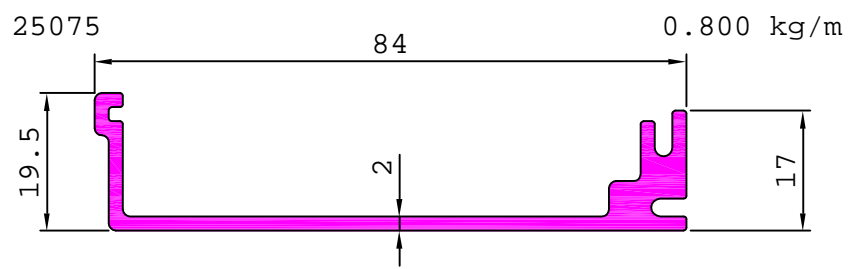
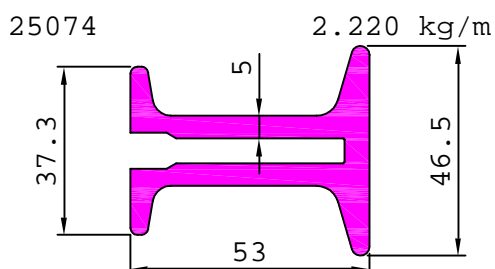
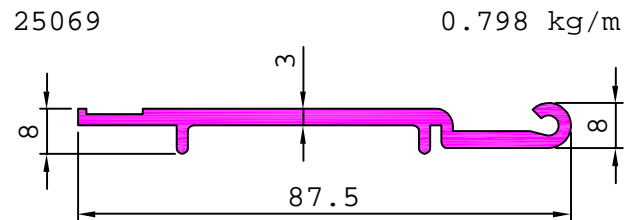
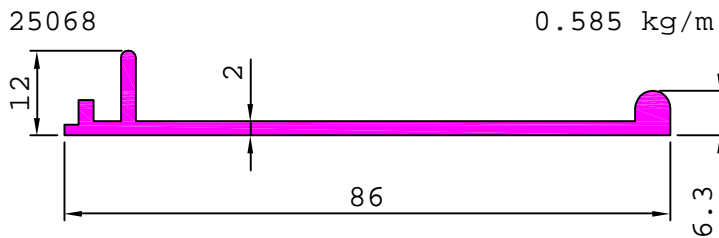

ELECTRICALS

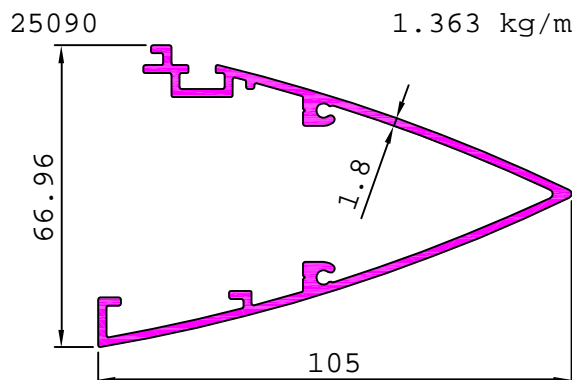
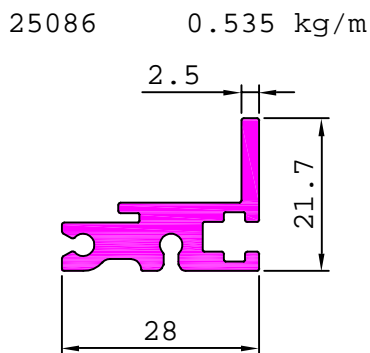
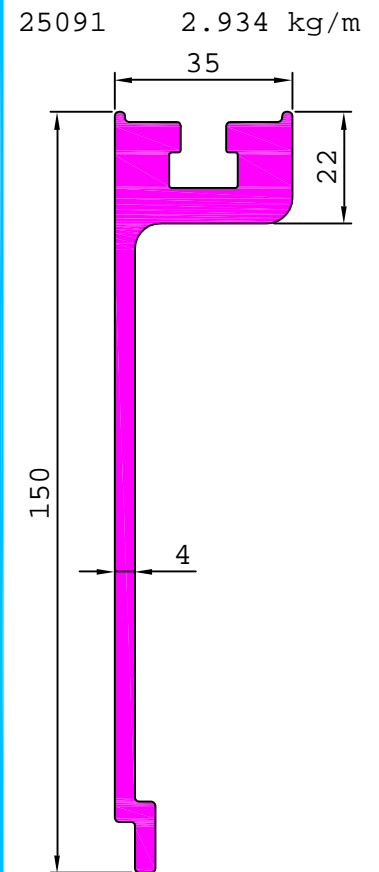
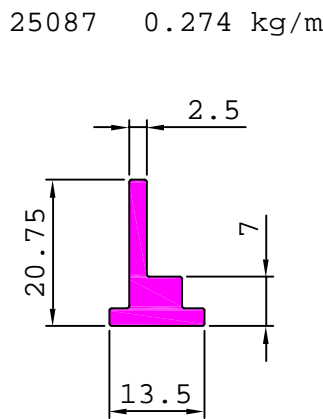
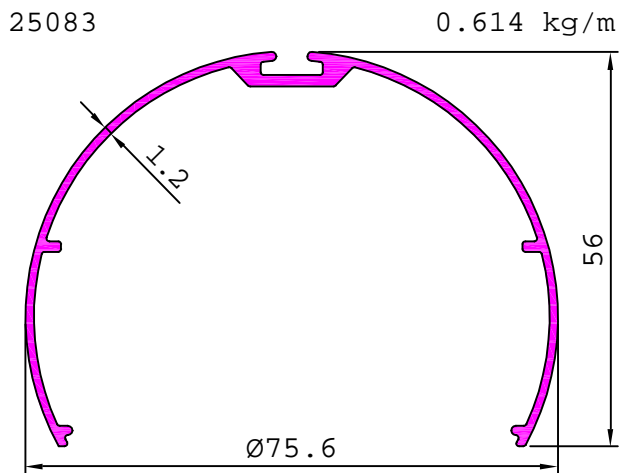
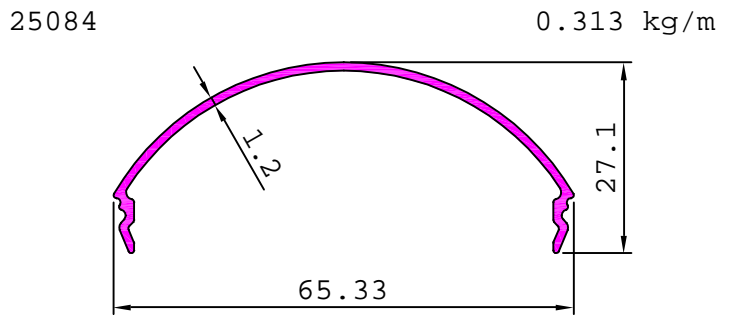
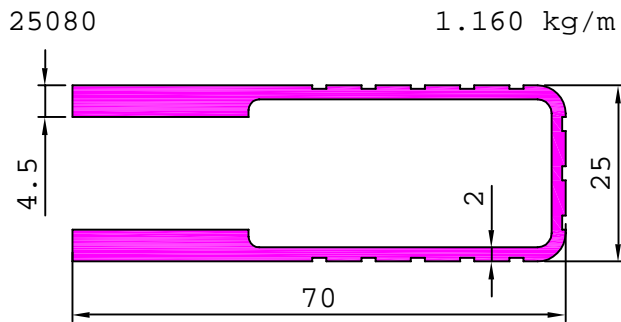
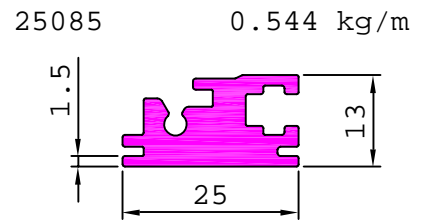
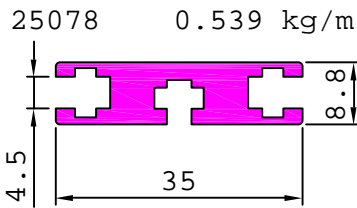
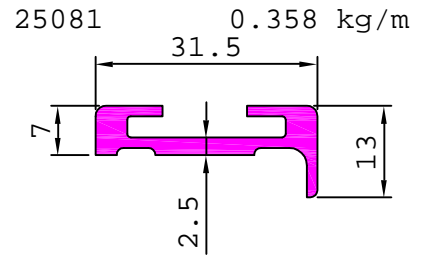
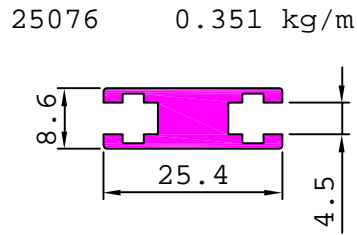
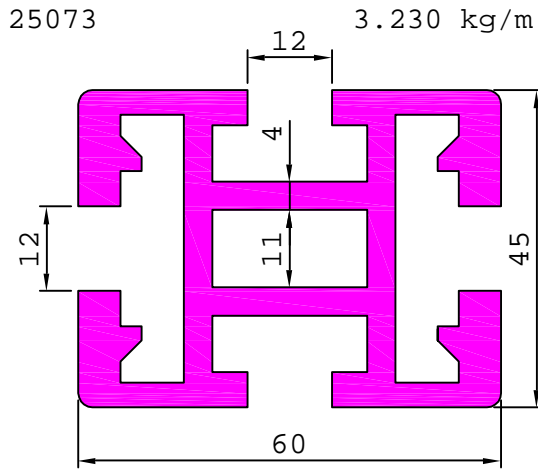

ELECTRICALS

25092 1.480 kg/m

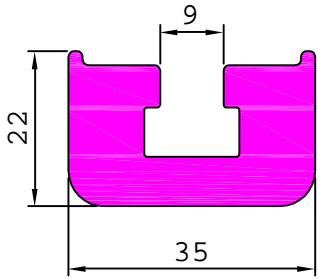

25095 5.913 kg/m

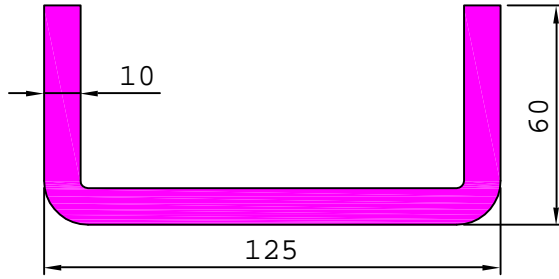

25096 0.199 kg/m

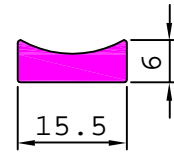

25097 0.560 kg/m

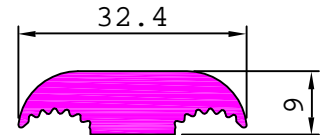

25093 4.836 kg/m

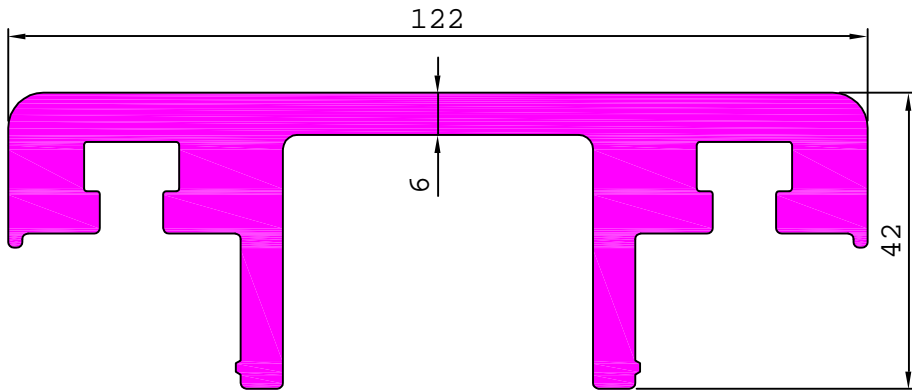

25098 1.341 kg/m

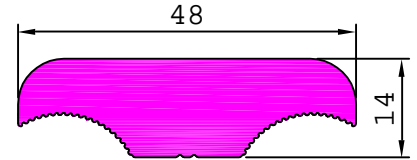

25099 0.881 kg/m

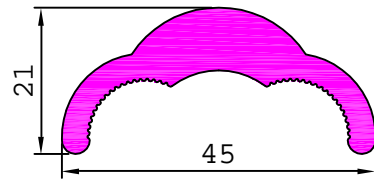

25100 2.325 kg/m

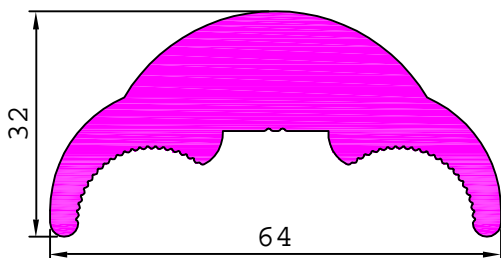

25106 13.099 kg/m

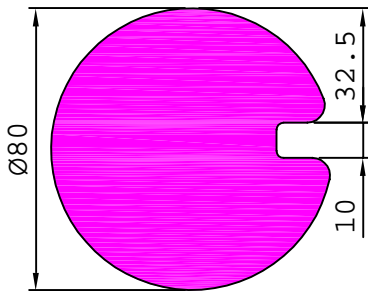

25110 0.428 kg/m

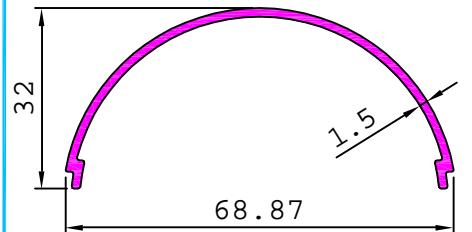

25103 4.071 kg/m

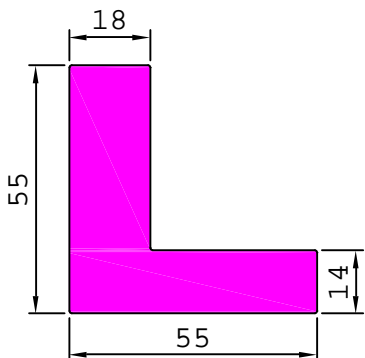

25116 0.441 kg/m

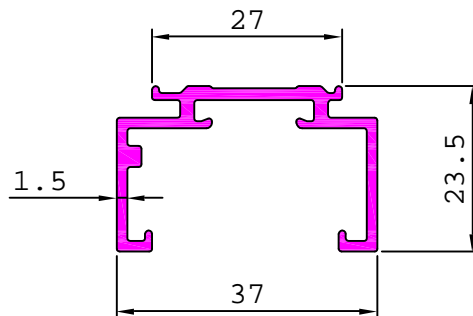

25118 0.410 kg/m

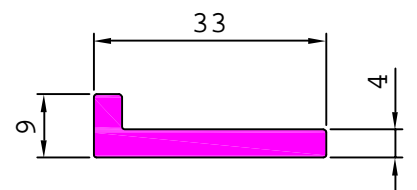

ELECTRICALS

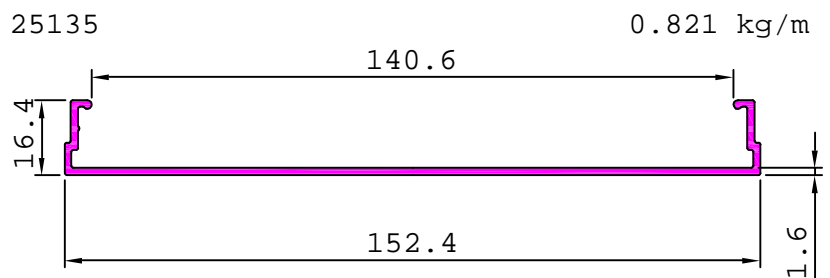
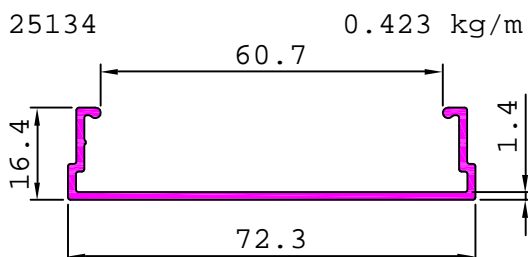
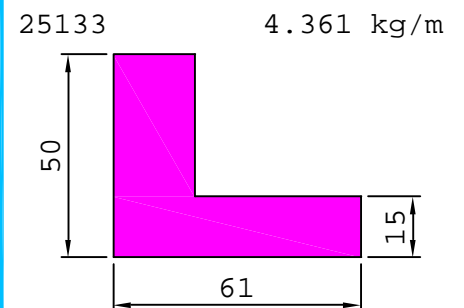
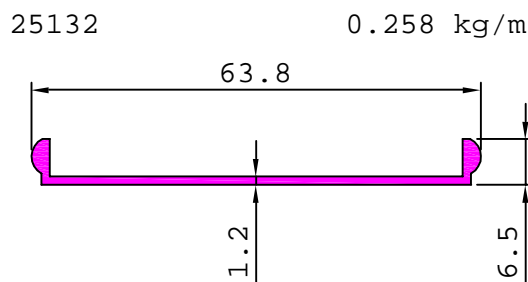
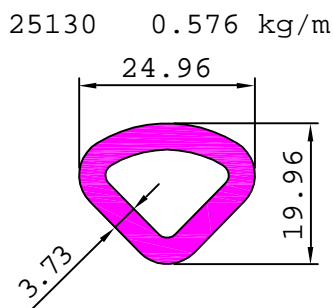
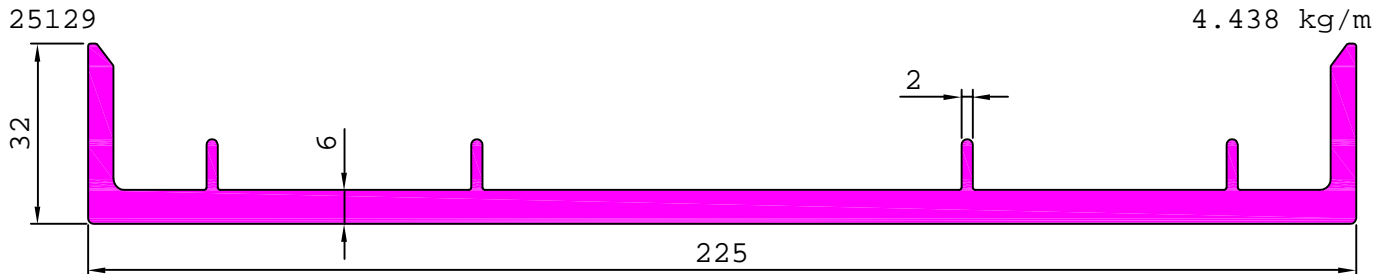
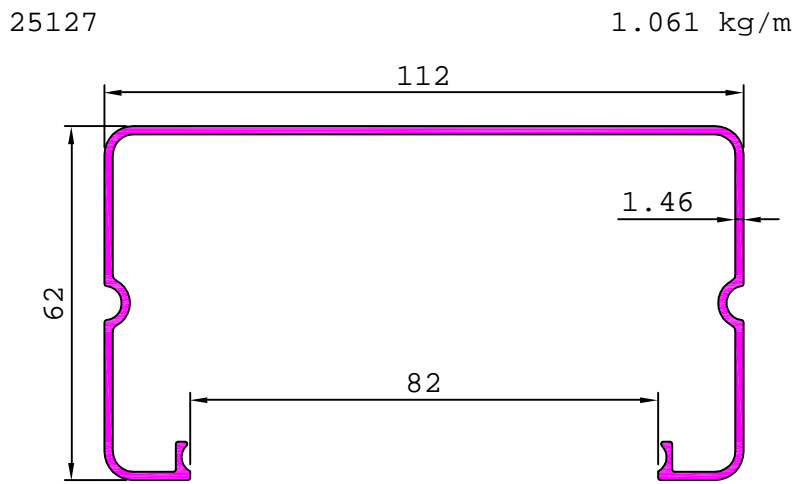
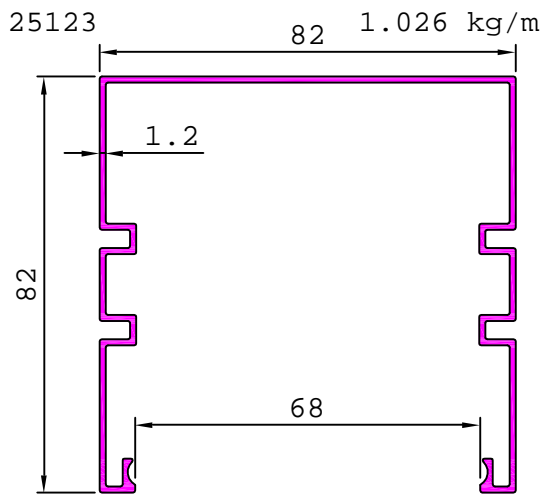
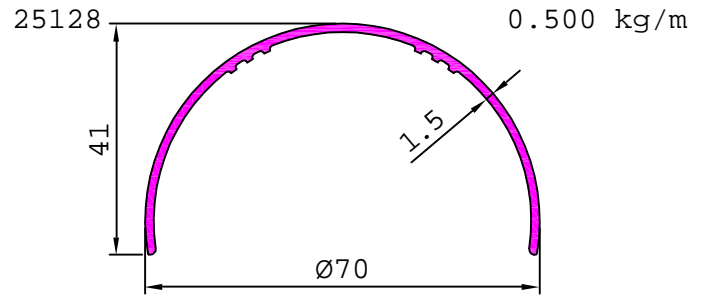
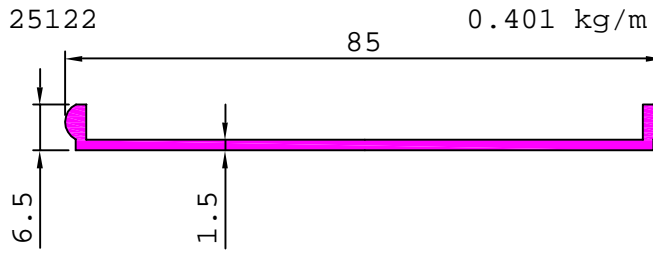

ELECTRICALS

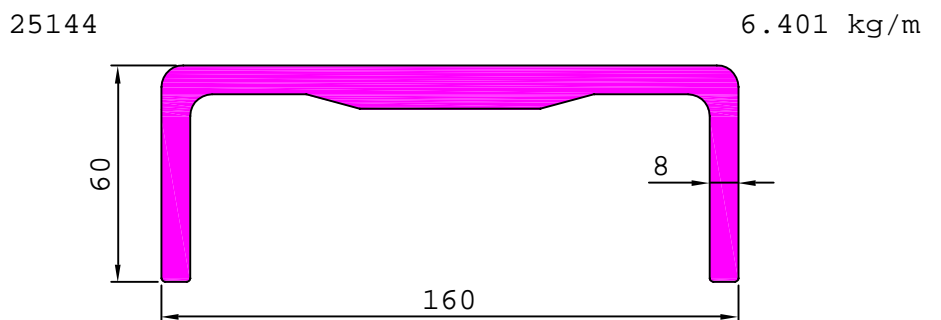
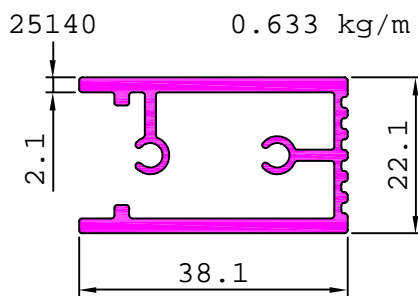
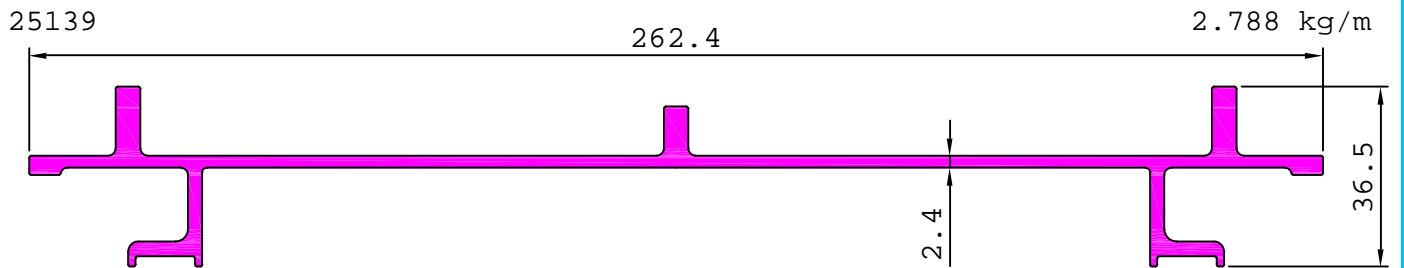
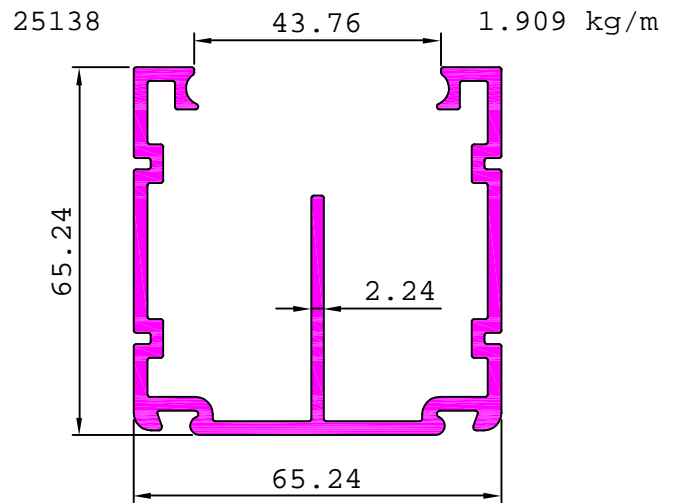
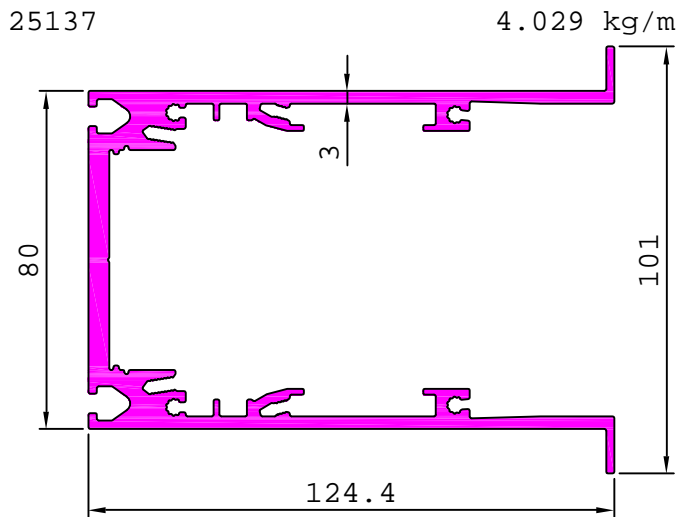
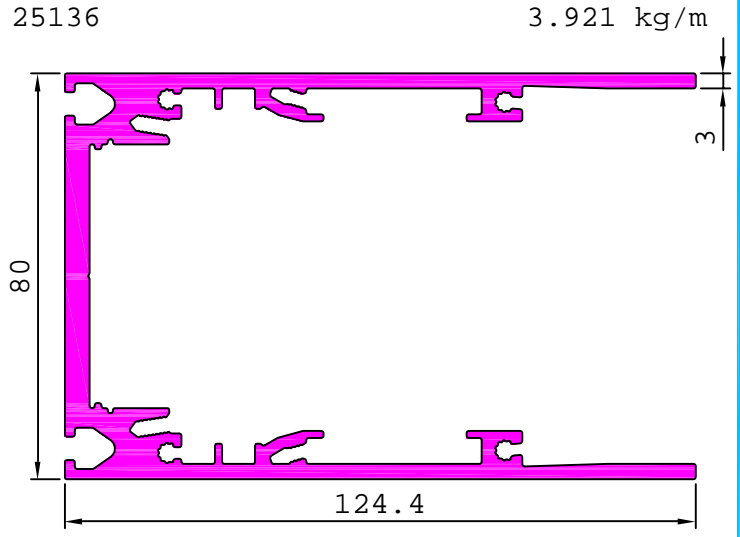
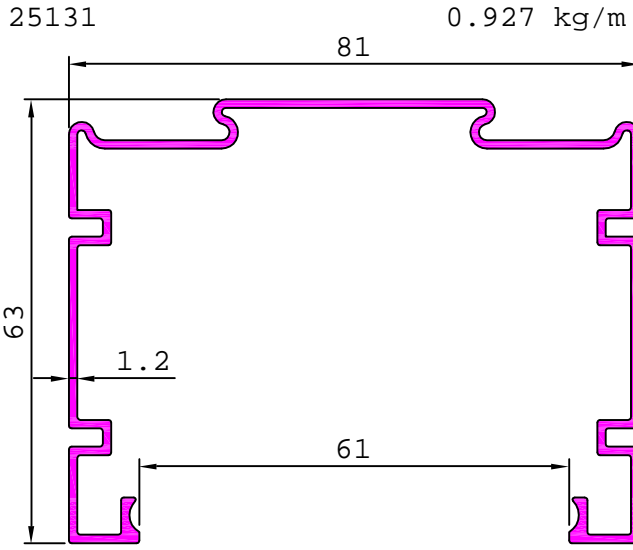

ELECTRICALS

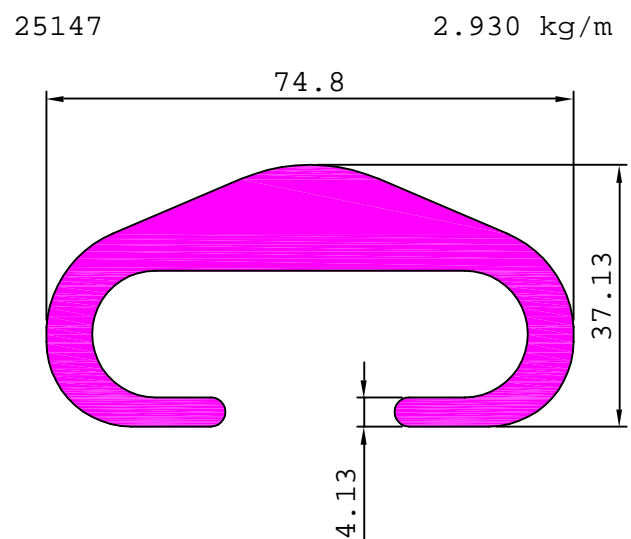
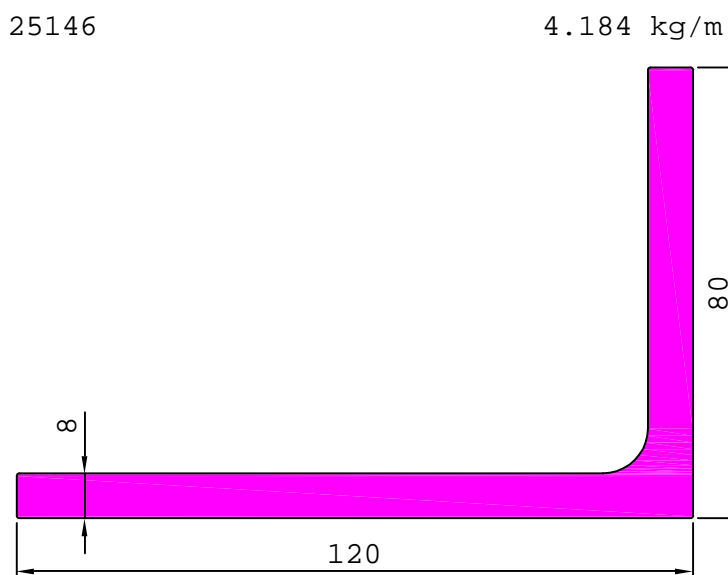
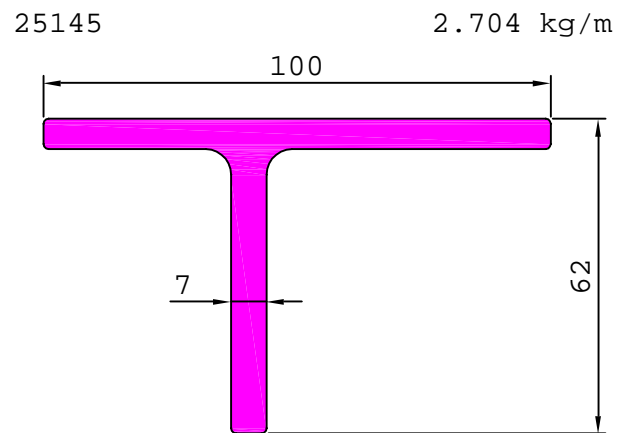
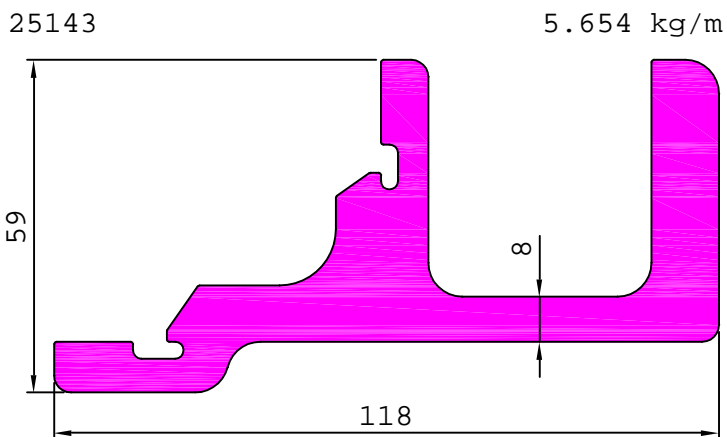
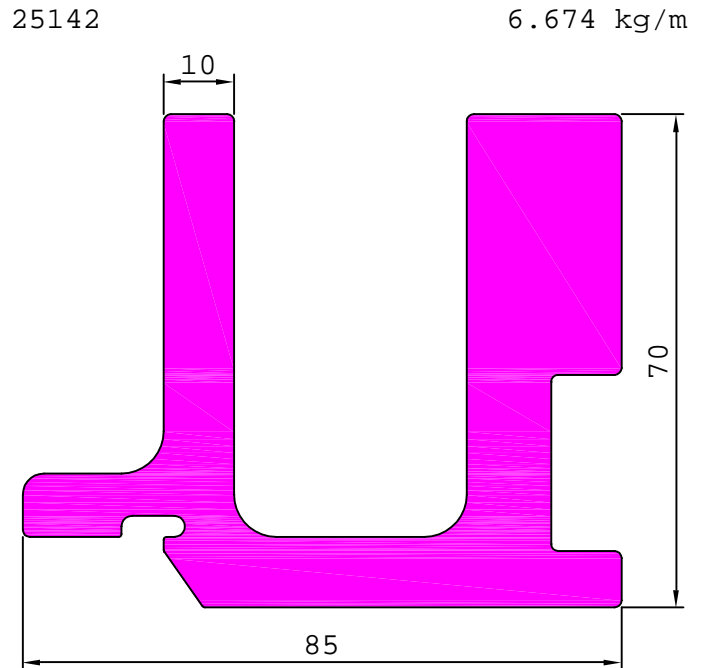
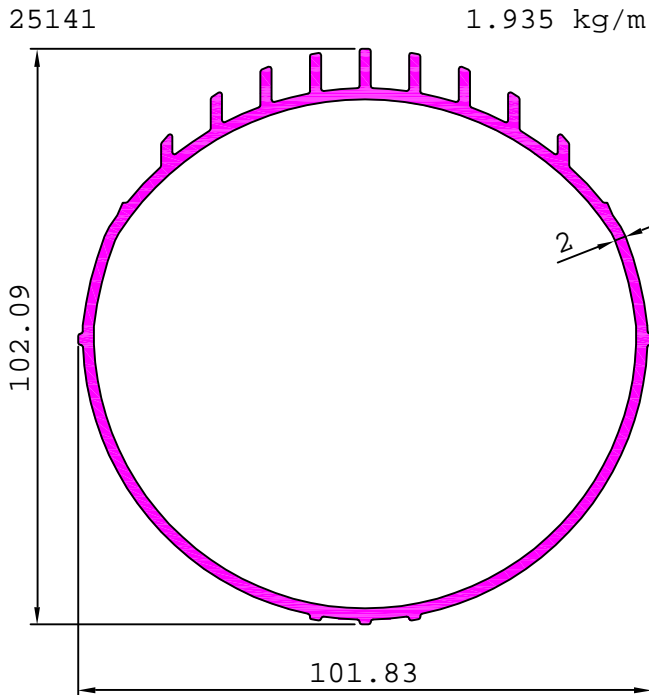

ELECTRICALS

25148

0.307 kg/m

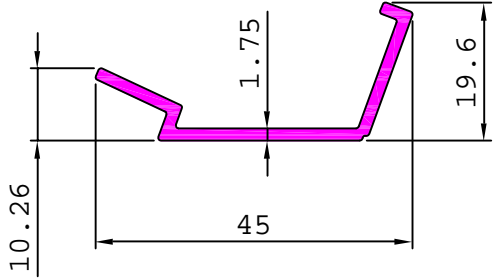

25149

3.827 kg/m

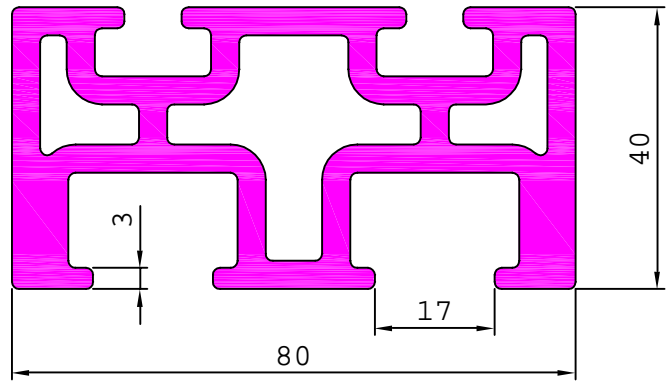

25150

1.026 kg/m

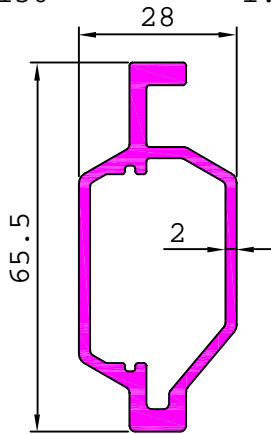

S1799

5.879 kg/m

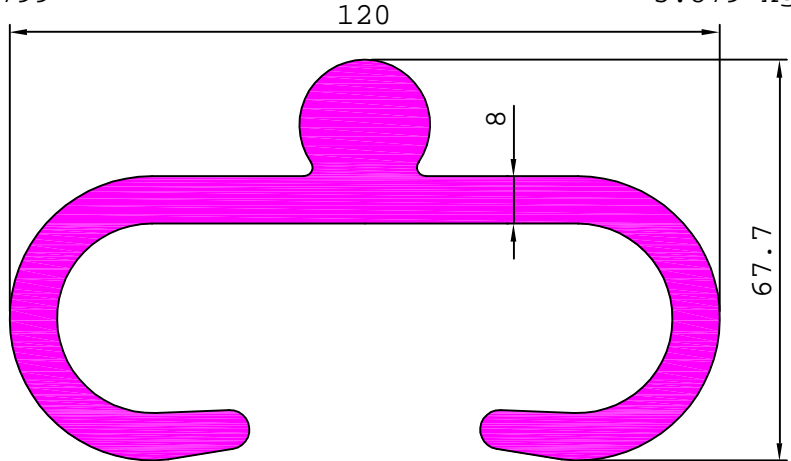

S1800

4.158 kg/m

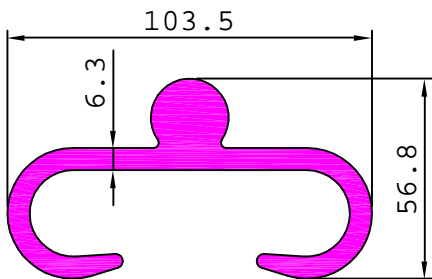

S1930

0.940 kg/m

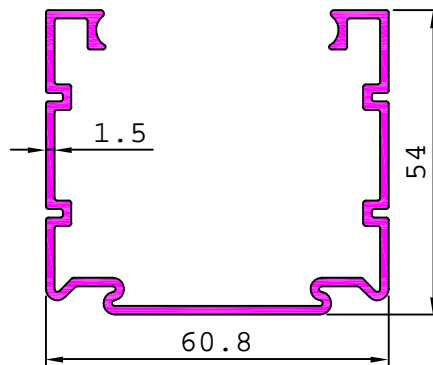

S1931

0.250 kg/m

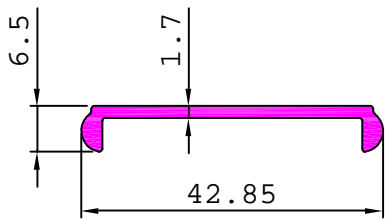

S1996

0.717 kg/m

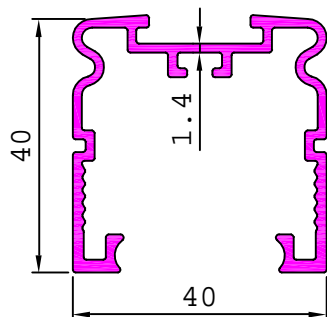

S1997

1.250 kg/m

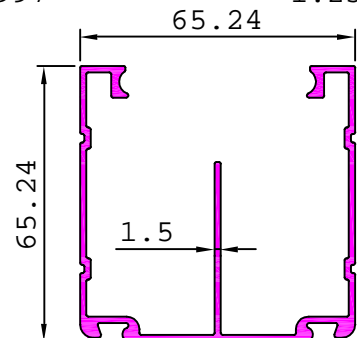

ELECTRICALS

S1717

0.121 kg/m

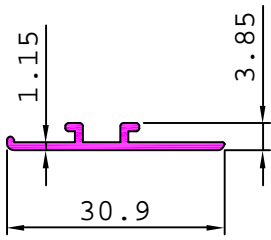

S2010

0.150 kg/m

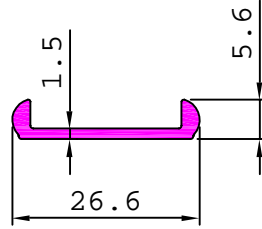

S2082

2.048 kg/m

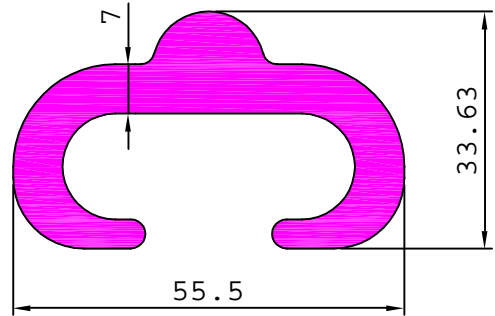

S1939

2.618 kg/m

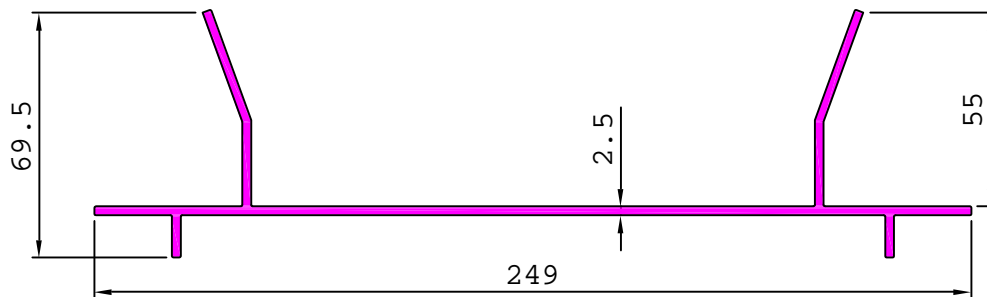

S2054

6.210 kg/m

