

CONVEYOR SECTION

28601

0.532 kg/m

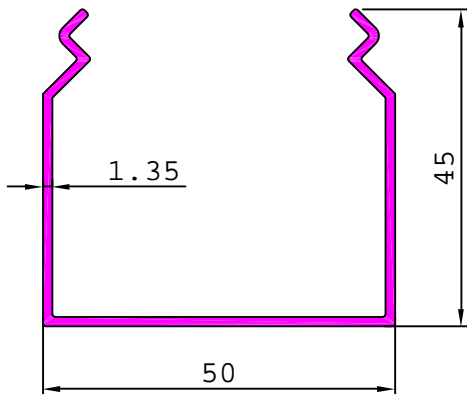

28602

0.284 kg/m

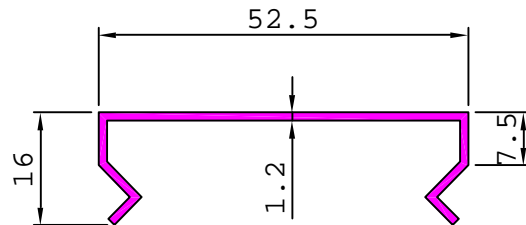

28603

3.495 kg/m

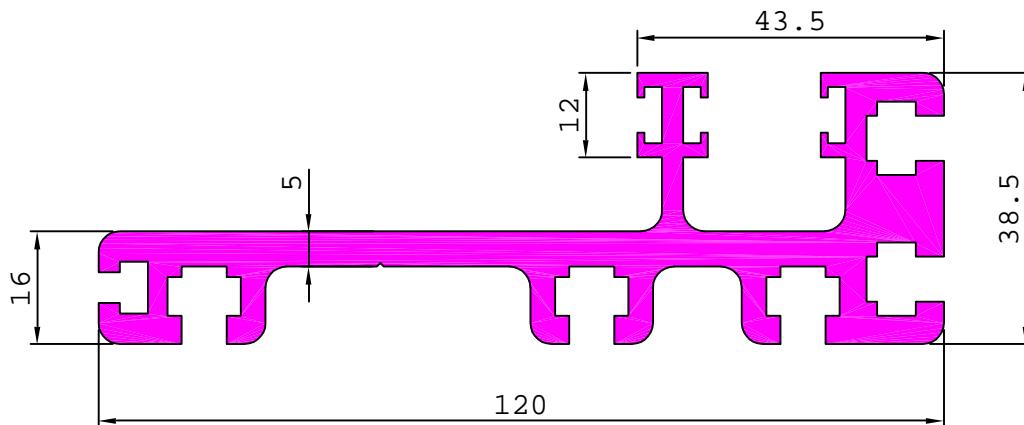

28604

1.394 kg/m

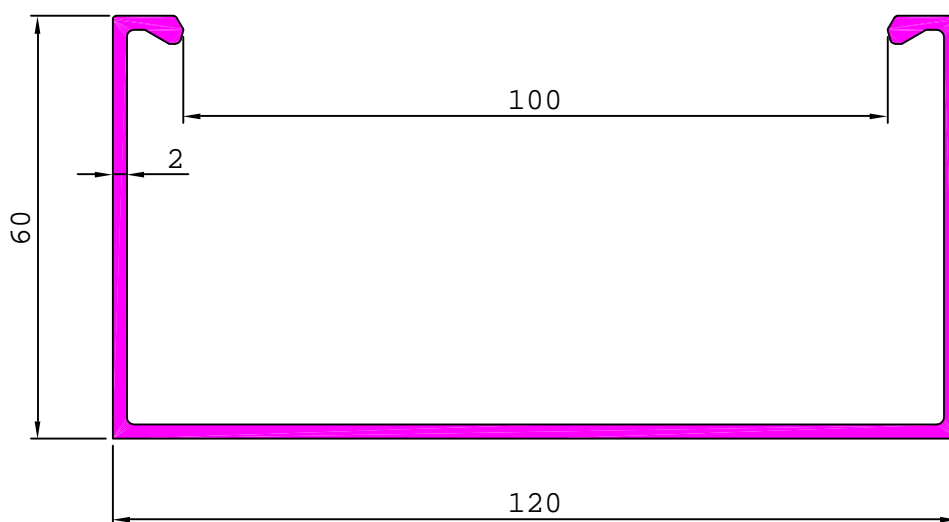

CONVEYOR SECTION

28605

0.830 kg/m

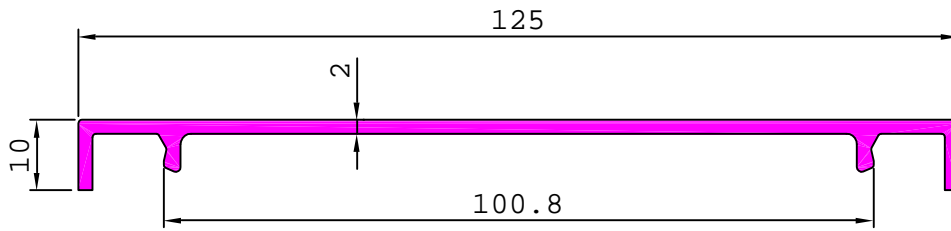

28606

3.856 kg/m

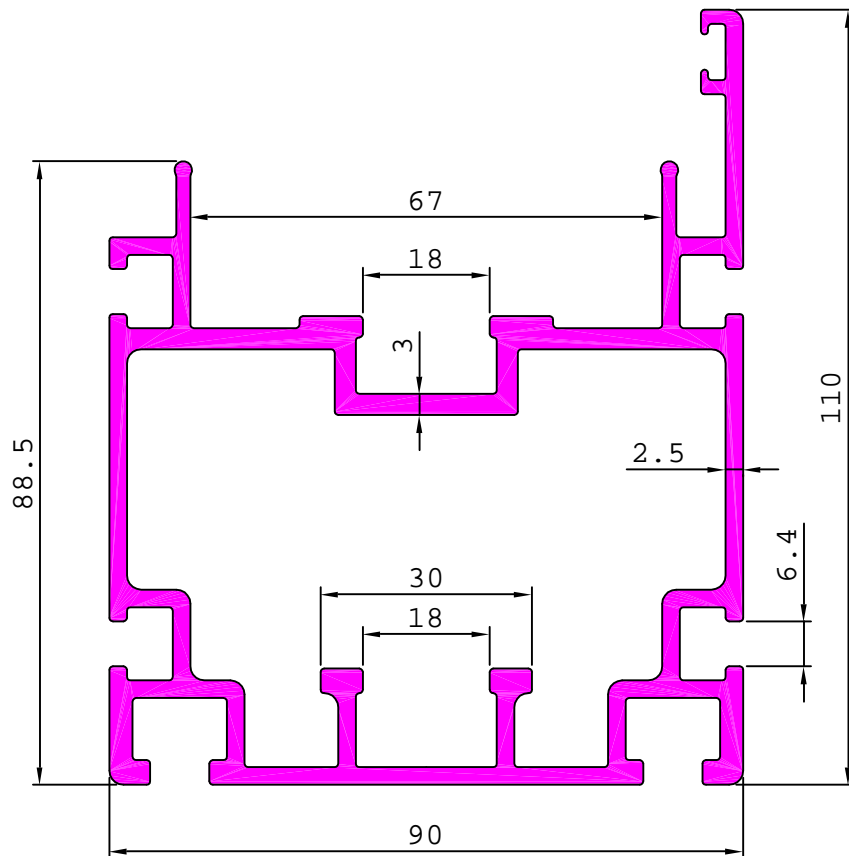

28608

3.057 kg/m

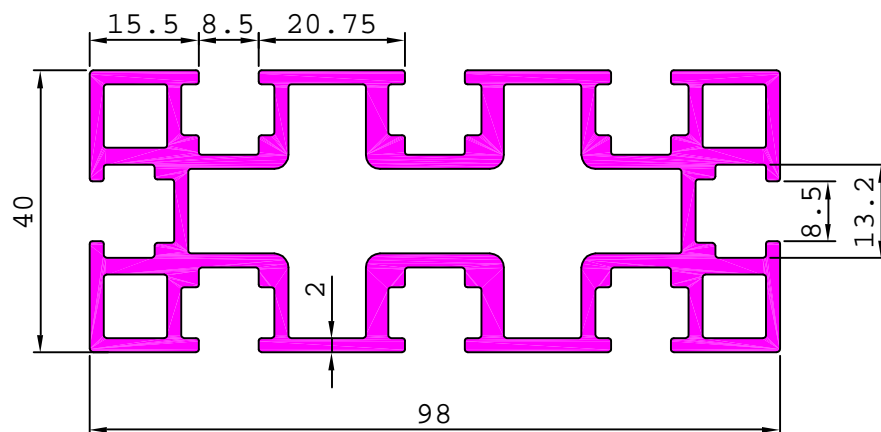

CONVEYOR SECTION

28609

3.615 kg/m

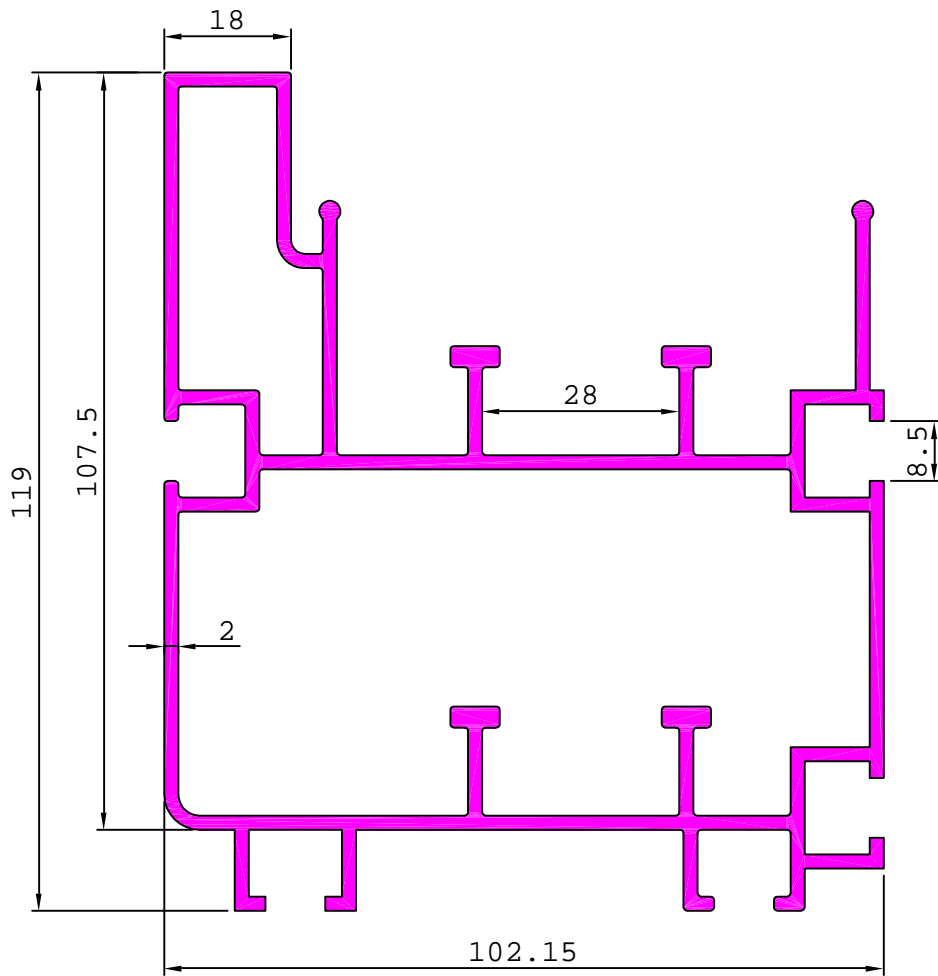

28610

6.631 kg/m

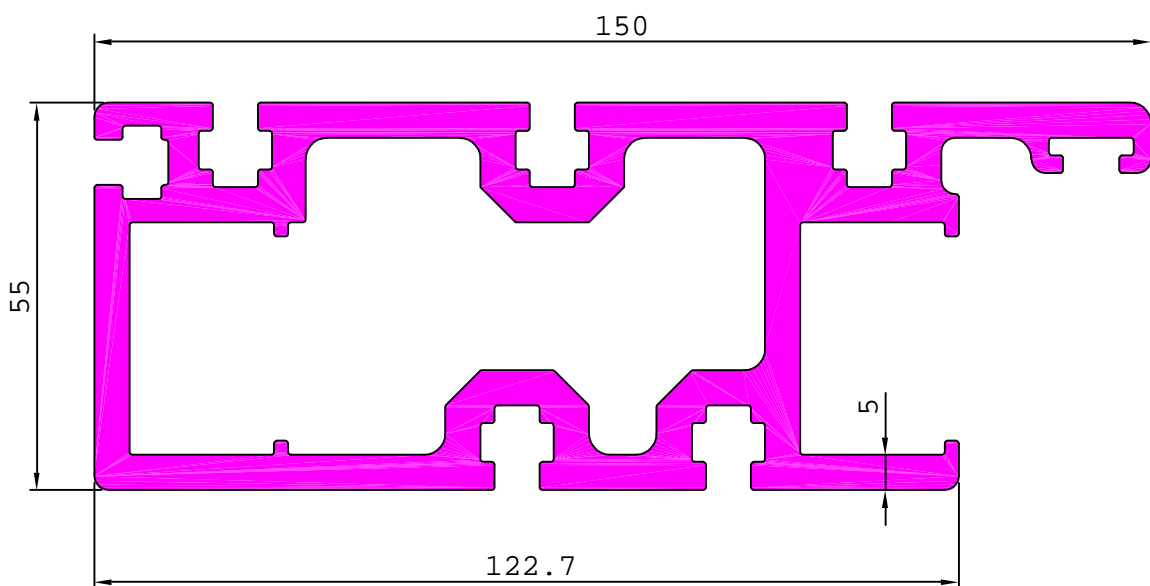

CONVEYOR SECTION

28611

3.096 kg/m

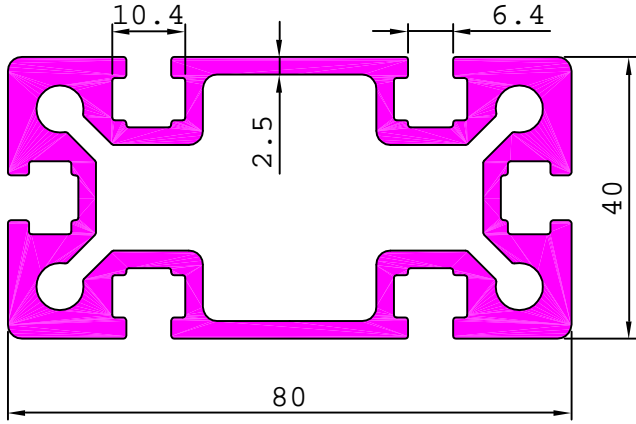

28612

1.298 kg/m

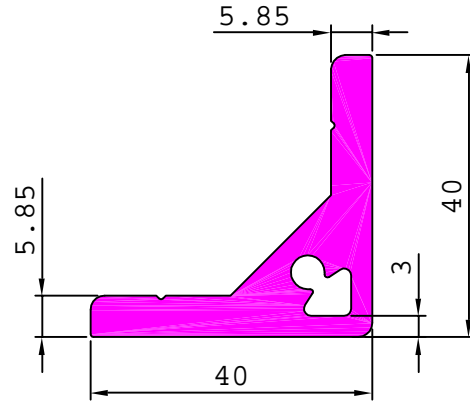

28614

4.300 kg/m

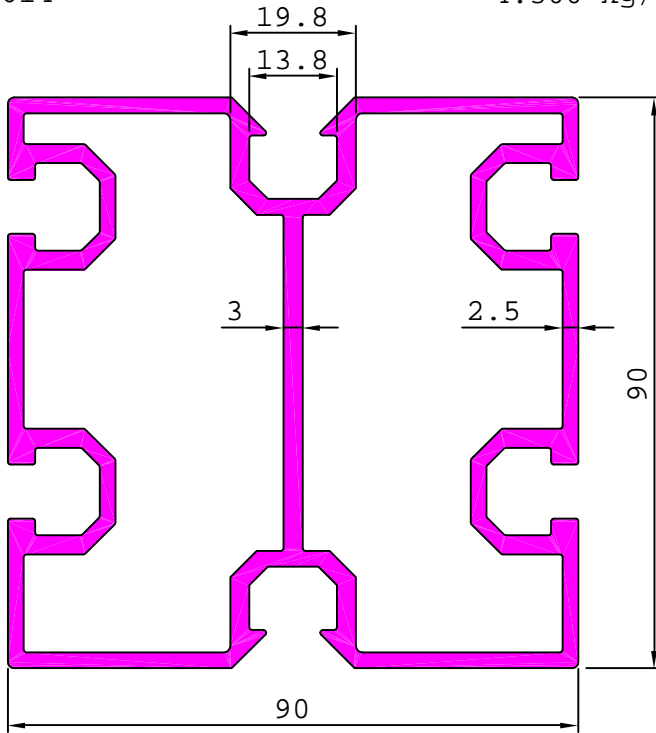

28616

2.648 kg/m

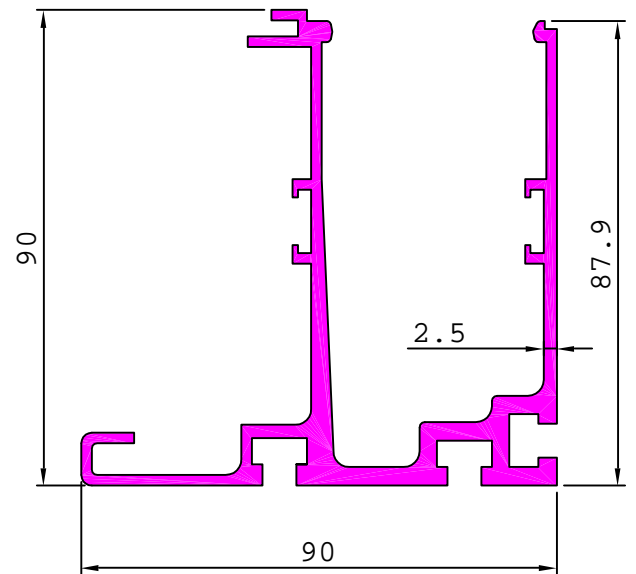

28617

0.226 kg/m

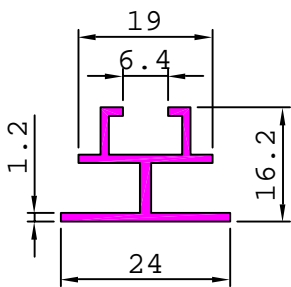

28618

1.733 kg/m

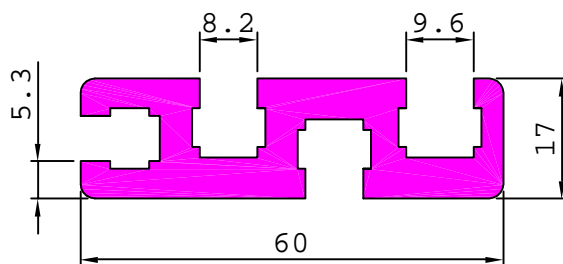

28619

1.506 kg/m

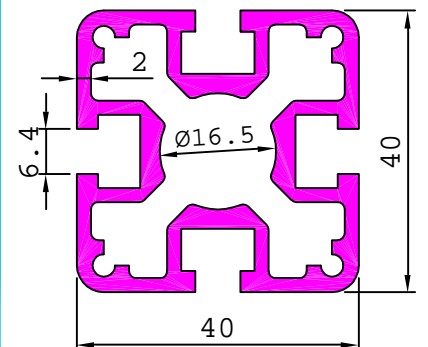

CONVEYOR SECTION

28615

5.360 kg/m

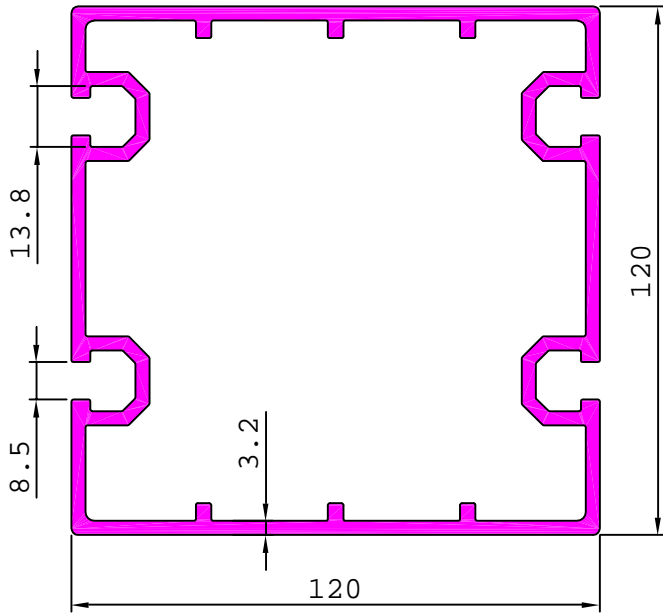

28620

1.070 kg/m

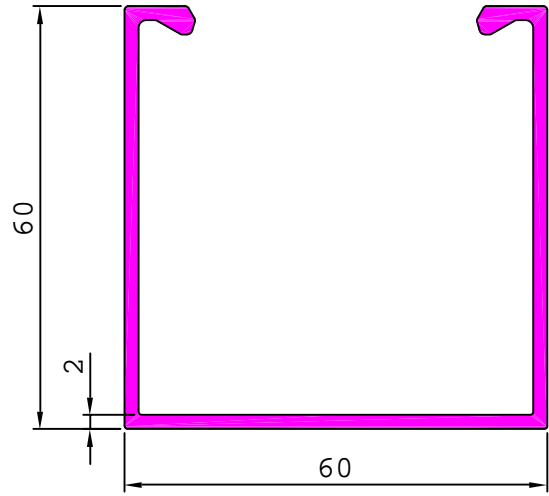

28621

0.504 kg/m

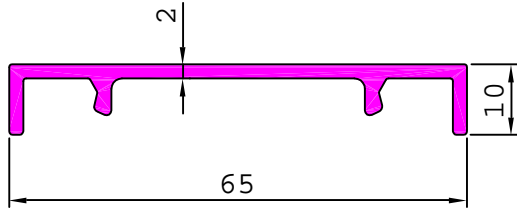

28622

3.878 kg/m

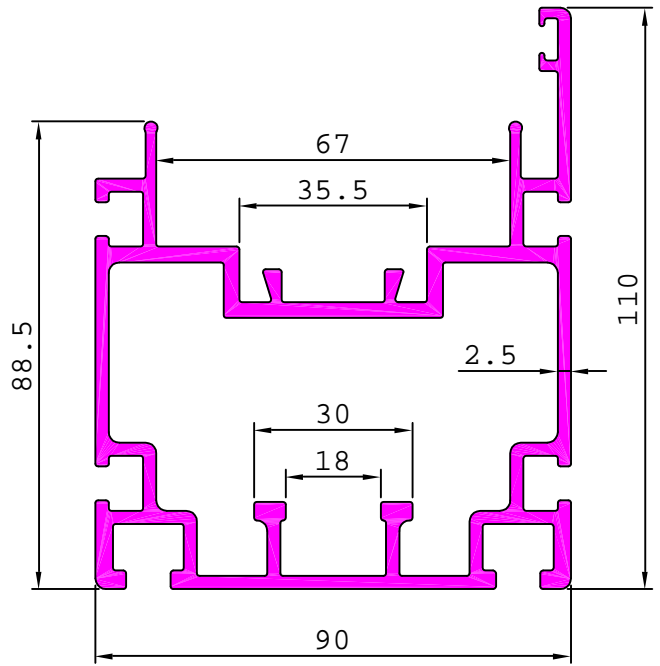

28623

5.706 kg/m

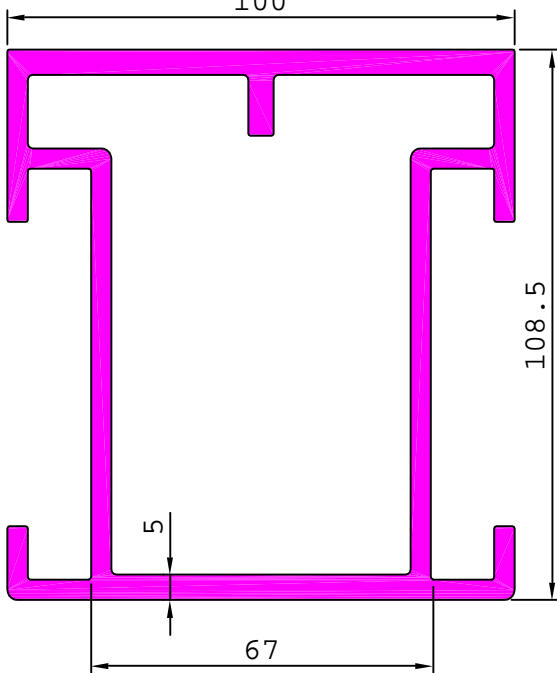

28624

0.292 kg/m

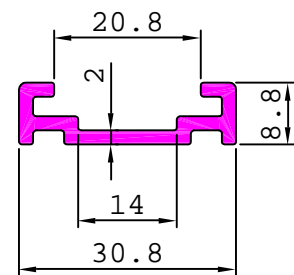

CONVEYOR SECTION

28625

0.305 kg/m

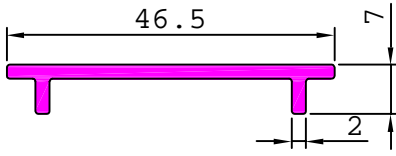

28626

6.119 kg/m

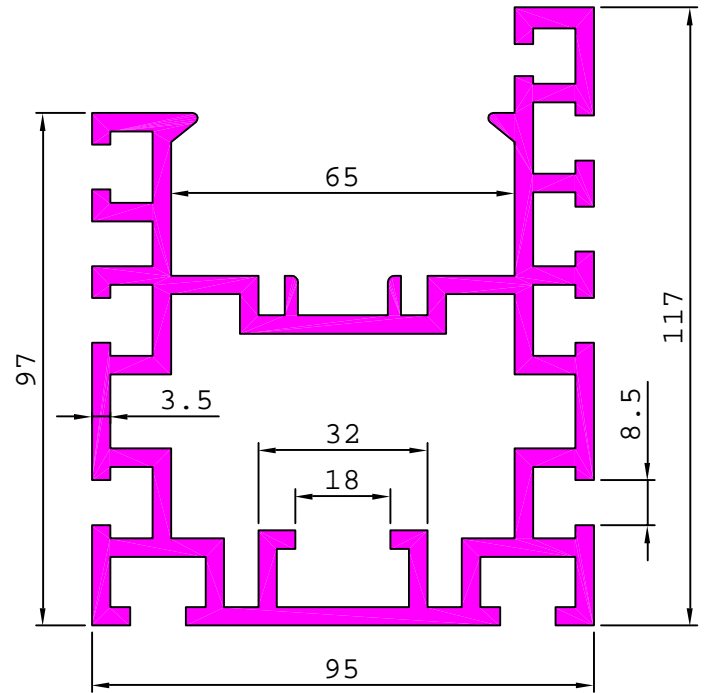

28627

4.094 kg/m

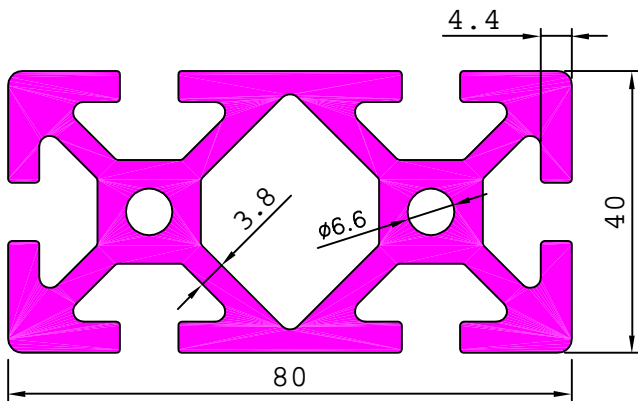

28628

1.553 kg/m

28629

4.202 kg/m

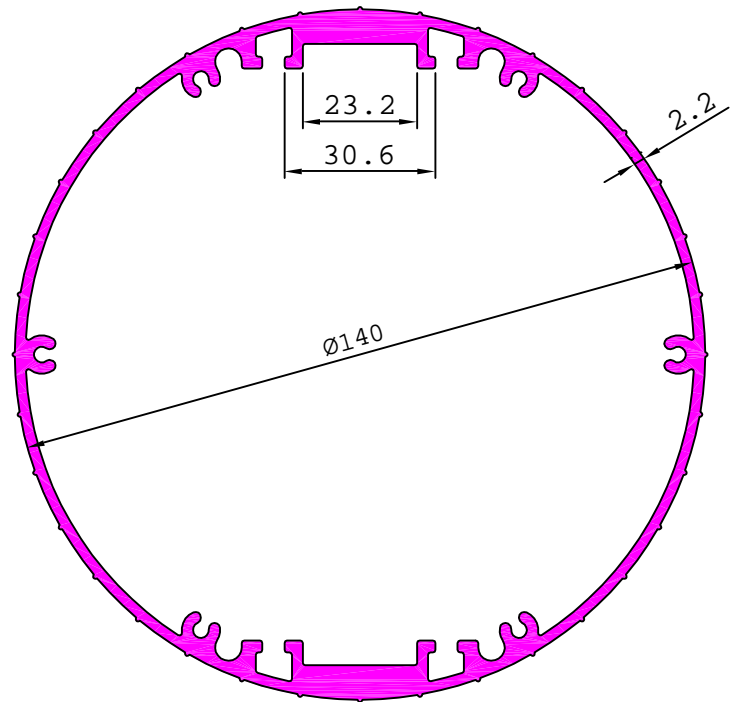
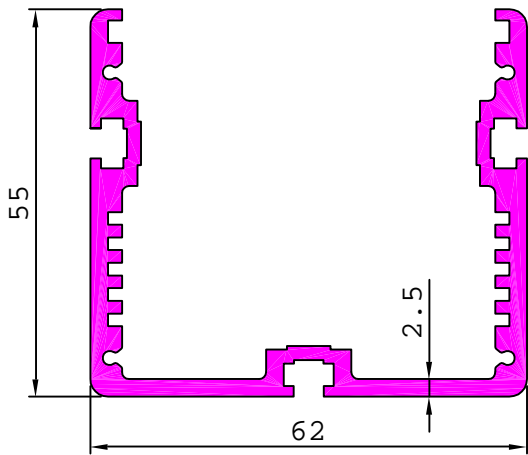

28632

0.997 kg/m

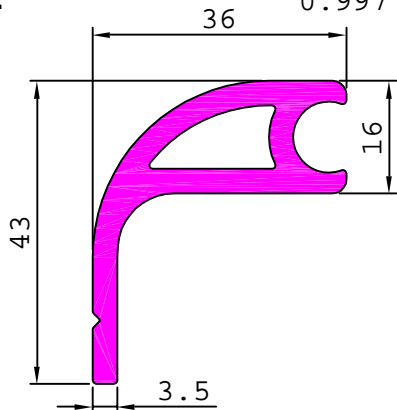

CONVEYOR SECTION

28630

7.368 kg/m

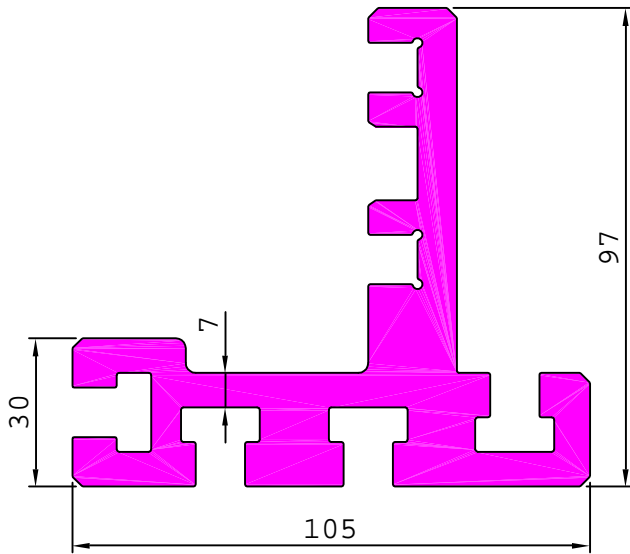

28631

5.942 kg/m

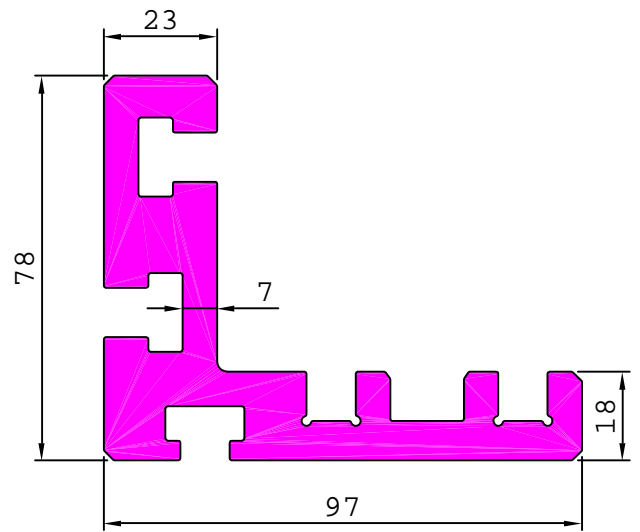

S1992 0.703 kg/m

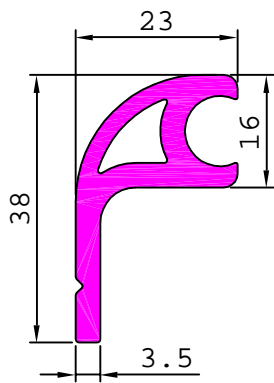

S2020

7.972 kg/m

