

FLAT BARS

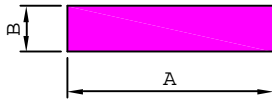

SL. No.	Section No.	A	B	Weight kg/m
1	10171	8.00	2.00	0.043
2	10318	8.50	8.00	0.183
3	10277	10.00	8.00	0.216
4	10351	11.50	6.35	0.197
5	10001	12.00	2.00	0.065
6	10061	12.00	3.00	0.097
7	10164	12.00	4.00	0.130
8	10063	12.00	7.00	0.227
9	10110	12.50	6.00	0.202
10	10036	12.70	5.00	0.171
11	10207	14.00	4.00	0.151
12	10153	15.00	2.00	0.081
13	10087	15.00	3.00	0.122
14	10144	15.00	8.00	0.324
15	10103	15.00	8.55	0.346
16	10149	15.30	8.00	0.330
17	10278	15.87	2.34	0.100
18	10135	16.95	4.15	0.190
19	10220	17.00	4.00	0.183
20	10160	17.50	1.80	0.085
21	10122	18.00	1.55	0.075
22	10109	18.00	2.50	0.121
23	10288	18.75	4.00	0.202
24	10279	19.00	1.82	0.093
25	10219	19.00	4.00	0.205
26	10003	19.00	5.00	0.257
27	10035	19.00	9.50	0.487
28	10123	19.05	2.25	0.116
29	10004	19.05	2.95	0.152
30	10005	19.05	3.18	0.163
31	10006	19.05	4.78	0.246
32	10007	19.05	6.35	0.327
33	10280	19.60	1.10	0.058
34	10118	20.00	1.60	0.086
35	10008	20.00	3.00	0.162
36	10223	20.00	4.00	0.215
37	10065	20.00	5.00	0.270
38	10106	20.00	6.00	0.324
39	10009	20.00	8.00	0.432
40	10138	20.00	10.00	0.540
41	10302	20.00	15.00	0.810
42	10129	22.00	2.00	0.118
43	10091	23.00	2.50	0.155
44	10155	23.60	1.70	0.108
45	10095	25.00	1.00	0.068
46	10116	25.00	1.50	0.101
47	10281	25.00	2.80	0.189
48	10010	25.00	3.00	0.203
49	10178	25.00	5.00	0.337
50	10011	25.00	6.00	0.405

SL. No.	Section No.	A	B	Weight kg/m
51	10270	25.00	6.50	0.439
52	10107	25.00	8.00	0.540
53	10197	25.00	15.00	1.013
54	10222	25.00	16.00	1.080
55	10075	25.40	2.00	0.137
56	10080	25.40	2.30	0.158
57	10012	25.40	2.95	0.202
58	10013	25.40	3.18	0.218
59	10034	25.40	4.00	0.274
60	10014	25.40	6.35	0.435
61	10152	25.40	9.52	0.652
62	10102	25.40	12.75	0.874
63	10191	25.40	19.05	1.304
64	10101	25.45	4.78	0.328
65	10094	27.00	15.00	1.093
66	10273	28.00	15.00	1.134
67	10212	29.78	1.78	0.143
68	10168	30.00	2.00	0.162
69	10265	30.00	2.90	0.235
70	10189	30.00	3.00	0.243
71	10015	30.00	5.00	0.405
72	10142	30.00	8.00	0.648
73	S2068	30.00	13.00	1.053
74	10274	30.00	15.00	1.215
75	10195	30.00	20.00	1.620
76	10016	30.18	3.18	0.259
77	10017	30.18	3.96	0.322
78	10079	31.75	2.30	0.197
79	10018	31.75	2.95	0.253
80	10077	31.75	4.78	0.410
81	10019	31.75	6.35	0.544
82	10086	31.75	9.52	0.816
83	10258	31.75	15.88	1.361
84	10198	31.75	19.05	1.633
85	10193	31.75	25.40	2.177
86	10226	32.00	6.00	0.518
87	10227	32.00	10.00	0.864
88	10120	33.50	12.00	1.085
89	10211	35.00	2.96	0.279
90	10243	36.00	2.65	0.257
91	10126	38.00	2.00	0.205
92	10190	38.00	3.00	0.308
93	10029	38.00	3.20	0.326
94	10181	38.00	5.00	0.513
95	10336	38.00	20.00	2.052
96	10020	38.10	3.18	0.327
97	10021	38.10	6.35	0.653
98	10033	38.10	4.78	0.492
99	10088	38.10	9.52	0.979
100	10104	38.10	12.70	1.306
101	10199	38.10	25.40	2.613
102	10267	38.10	31.75	3.226
103	10140	40.00	1.60	0.173
104	10031	40.00	3.00	0.324
105	10047	40.00	4.00	0.432
106	10048	40.00	5.00	0.540
107	10165	40.00	6.50	0.702
108	10148	40.00	8.00	0.864

SL. No.	Section No.	A	B	Weight kg/m
109	10057	40.00	10.00	1.080
110	10083	40.00	12.00	1.296
111	10093	40.00	15.00	1.620
112	10137	40.00	20.00	2.116
113	S2077	40.00	33.00	3.564
114	10022	42.00	6.00	0.680
115	10307	42.00	27.00	3.061
116	S2004	44.00	16.00	1.900
117	10023	44.45	3.18	0.382
118	S1787	44.45	12.70	1.524
119	10068	44.45	19.05	2.286
120	10218	44.45	25.40	3.048
121	10162	45.00	25.00	3.037
122	12146	45.00	32.00	3.888
123	10067	47.00	2.00	0.254
124	10119	48.00	5.50	0.713
125	10114	48.00	14.50	1.879
126	10143	50.00	3.00	0.405
127	10030	50.00	4.00	0.540
128	10072	50.00	5.00	0.675
129	10069	50.00	6.00	0.810
130	10234	50.00	6.45	0.871
131	10251	50.00	6.50	0.877
132	10081	50.00	7.50	1.013
133	10100	50.00	8.00	1.080
134	10042	50.00	10.00	1.350
135	10232	50.00	12.00	1.619
136	10113	50.00	13.70	1.870
137	10145	50.00	15.00	2.025
138	10286	50.00	20.00	2.700
139	10024	50.80	6.35	0.870
140	10037	50.80	9.52	1.306
141	10038	50.80	12.70	1.742
142	10071	50.80	15.88	2.178
143	10200	50.80	19.05	2.613
144	10275	50.80	22.22	3.047
145	10217	50.80	25.40	3.483
146	10259	50.80	44.45	6.096
147	10256	54.00	3.30	0.481
148	10173	55.00	35.00	5.198
149	10201	57.15	12.70	1.960
150	10293	59.54	6.35	1.020
151	10312	59.95	3.33	0.539
152	10053	60.00	6.00	0.972
153	10039	60.00	10.00	1.620
154	10196	60.00	20.00	3.240
155	10156	60.00	30.00	4.860
156	10328	60.45	1.85	0.302
157	10208	61.00	43.00	7.082
158	10184	63.00	38.00	6.464
159	10325	63.50	4.76	0.816
160	10025	63.50	6.35	1.089
161	10073	63.50	9.52	1.632
162	10202	63.50	19.05	3.266
163	10192	63.50	22.22	3.810
164	10194	63.50	25.40	4.355
165	10260	63.50	31.75	5.443
166	10203	63.50	44.45	7.621

FLAT BARS

SL. No.	Section No.	A	B	Weight kg/m
167	10268	63.50	50.80	8.709
168	10050	64.00	12.00	2.074
169	S1803	64.50	4.00	0.696
170	10112	65.00	5.75	1.009
171	10131	65.00	50.00	8.775
172	10098	66.00	9.00	1.604
173	10295	66.50	14.20	2.550
174	10296	66.50	29.00	5.207
175	10216	69.85	50.80	9.580
176	10225	70.00	3.18	0.601
177	10245	70.00	12.00	2.268
178	10331	70.00	20.00	3.780
179	10188	70.00	30.00	5.670
180	10206	72.00	52.00	10.109
181	10269	73.00	2.70	0.532
182	10166	75.00	5.00	1.013
183	10125	75.00	10.00	2.025
184	10084	75.00	12.00	2.430
185	10111	75.00	12.50	2.531
186	10062	75.00	14.00	2.835
187	10335	75.00	30.00	6.075
188	10052	76.00	15.00	3.078
189	10026	76.20	6.35	1.306
190	10059	76.20	9.52	1.958
191	10058	76.20	12.70	2.613
192	10204	76.20	19.05	3.919
193	10285	76.20	25.40	5.225
194	10205	76.20	31.75	6.532
195	10315	76.20	38.10	7.838
196	10287	80.00	4.00	0.864
197	10049	80.00	6.00	1.296
198	10054	80.00	8.00	1.728
199	10060	80.00	10.00	2.160
200	10261	80.00	20.00	4.320
201	10154	80.00	30.00	6.480
202	10253	80.00	25.00	5.400
203	10130	80.00	70.00	15.120
204	10133	85.00	65.00	14.918
205	10136	85.72	34.92	8.082
206	10236	88.00	45.00	10.692
207	10321	88.90	76.20	18.290
208	10350	90.00	30.00	7.290
209	10040	91.00	5.20	1.278
210	10353	91.00	8.00	1.965
211	10117	95.00	5.00	1.282
212	10064	100.00	10.00	2.700
213	10045	100.00	12.00	3.240
214	10082	100.00	12.50	3.375
215	10055	100.00	15.00	4.050
216	10096	100.00	20.00	5.400
217	10147	100.00	25.00	6.750
218	10324	100.00	30.00	8.100
219	10186	100.00	50.00	13.500
220	10158	100.00	80.00	21.600
221	10305	100.30	16.00	4.333
222	10028	101.60	6.35	1.742
223	10046	101.60	12.70	3.484
224	10215	101.60	22.22	6.095

SL. No.	Section No.	A	B	Weight kg/m
225	10214	101.60	25.40	6.967
226	10262	101.60	50.80	13.935
227	10306	101.60	51.00	13.990
228	10345	102.00	10.80	2.974
229	10304	102.00	36.00	9.914
230	10276	102.00	82.00	22.583
231	10309	103.00	53.00	14.739
232	10310	103.50	6.80	1.899
233	10043	105.00	15.00	4.253
234	10301	107.50	2.65	0.769
235	10090	110.00	12.00	3.564
236	10169	110.00	30.00	8.910
237	10235	112.00	60.00	18.144
238	10239	115.00	3.30	1.025
239	10127	115.00	25.00	7.762
240	10257	115.00	60.00	18.630
241	10175	116.00	3.00	0.939
242	10308	117.00	42.00	13.267
243	S2057	118.00	31.00	9.876
244	10051	120.00	10.00	3.240
245	10124	120.00	25.00	8.100
246	10163	121.00	12.00	3.920
247	10299	122.00	12.70	4.183
248	10298	122.00	17.00	5.600
249	10271	122.00	38.10	12.550
250	10303	123.00	2.90	0.963
251	10228	125.00	50.80	17.145
252	10213	127.00	3.00	1.028
253	10076	127.00	6.35	2.177
254	10041	127.00	9.52	3.264
255	10151	127.00	12.70	4.355
256	10263	127.00	50.80	17.419
257	10159	127.00	76.20	26.129
258	10317	130.00	10.00	3.510
259	10172	130.00	13.00	4.563
260	10283	130.00	65.00	22.815
261	10230	135.00	44.45	16.202
262	10231	135.00	82.55	30.089
263	10337	136.00	6.50	2.386
264	10300	137.00	20.00	7.398
265	10132	140.00	10.00	3.780
266	10316	140.00	15.80	5.972
267	10170	140.00	50.00	18.900
268	10085	150.00	6.00	2.430
269	10128	150.00	7.50	3.037
270	10292	150.00	8.00	3.224
271	10066	150.00	10.00	0.050
272	10089	150.00	12.00	4.860
273	10294	150.00	16.00	6.480
274	10097	150.00	19.00	7.695
275	10174	150.00	20.00	8.100
276	10070	150.00	25.00	10.125
277	10134	150.00	30.00	12.150
278	10185	150.00	40.00	16.200
279	10249	150.00	45.00	18.225
280	10284	150.00	75.00	30.375
281	10105	152.40	6.40	2.633
282	10179	152.40	12.70	5.225

SL. No.	Section No.	A	B	Weight kg/m
283	10252	152.40	31.75	13.064
284	10264	152.40	50.80	20.903
285	10176	154.00	2.00	0.832
286	10352	158.00	8.50	3.626
287	10229	158.00	35.00	14.930
288	10250	160.00	6.00	2.592
289	10247	160.00	18.00	7.776
290	10167	160.00	25.00	10.800
291	10240	160.00	55.00	23.800
292	10115	162.00	10.00	4.374
293	10238	165.00	14.00	6.236
294	10297	167.00	22.00	9.920
295	10319	167.00	30.00	13.527
296	10320	167.00	68.00	30.661
297	10221	170.00	32.00	14.688
298	10272	172.00	12.00	5.572
299	10233	173.00	14.00	6.539
300	10187	175.00	50.00	23.625
301	10210	175.00	52.00	24.570
302	10254	178.00	10.50	5.045
303	10244	178.00	19.50	9.371
304	10182	180.00	40.00	19.440
305	10183	190.00	4.00	2.052
306	10209	190.00	50.00	25.650
307	10313	195.00	30.00	15.795
308	10326	200.00	8.00	4.320
309	10255	200.00	10.00	5.400
310	10180	200.00	13.00	7.020
311	10341	200.00	25.00	13.500
312	10266	203.20	12.70	6.967
313	10289	203.00	16.00	8.770
314	10224	204.00	5.00	2.754
315	10237	208.00	45.00	25.272
316	10339	210.00	11.00	6.237
317	10333	210.00	12.00	6.804
318	10338	210.00	15.00	8.505
319	10291	210.00	23.00	13.041
320	10282	215.90	22.22	12.952
321	10311	220.00	8.00	4.752
322	10323	228.60	26.50	16.356
323	S1935	230.00	6.00	3.726
324	10334	232.00	42.00	26.308
325	10290	238.00	16.00	10.282
326	10241	245.00	18.00	11.907
327	10330	246.00	20.00	13.284
328	10327	250.00	10.00	6.750
329	10346	254.00	12.70	8.709
330	10242	258.00	18.00	12.539
331	10340	270.00	10.00	7.290
332	S1738	285.00	16.00	12.312
333	10329	290.00	20.00	15.660
334	10322	304.80	26.50	21.808
335	10314	320.00	20.00	17.28

ROUND RODS

ROUND RODS

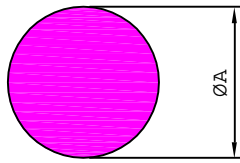

* EXTRUDED & DRAWN

SL. No.	Section No.	ØA	Weight kg/m
1	11041	4.00	0.034
2	11053	4.40	0.041
3	11042	5.00	0.053
4	11072	5.50	0.064
5	11047	6.00	0.076
6	11001	6.35	0.086
7	11044	6.40	0.087
8	11139	7.00	0.104
9	11059	7.20	0.110
10	11081	7.65	0.124
11	11002	7.94	0.134
12	11029	8.00	0.136
13	11043	8.26	0.145
14	11003	8.50	0.153
15	11068	8.85	0.166
16	11004	9.00	0.172
17	11067	9.18	0.179
18	11046	9.30	0.183
19	11005	9.52	0.192
20	11069	9.66	0.198
21	11106	9.80	0.203
22	11006	10.00	0.212
23	11070	10.80	0.247
24	11007	11.00	0.257
25	11128	11.20	0.266
26	11071	11.53	0.282
27	11082	11.70	0.290
28	11008	12.00	0.305
29	11009	12.70	0.342
30	11010	13.00	0.358
31	11011	13.50	0.386
32	11116	14.00	0.416
33	11022	14.30	0.434
34	11012	14.50	0.446
35	11085	15.00	0.477
36	11066	15.30	0.496
37	11083	15.60	0.516
38	11129	15.70	0.523
39	11013	15.88	0.535
40	11025	16.00	0.543
41	11133	16.25	0.560
42	11079	16.70	0.591
43	11135	17.00	0.613
44	11026	17.50	0.649
45	11023	18.00	0.687
46	11096	18.30	0.710
47	11113	19.00	0.765
48	11014	19.05	0.770
49	11054	19.60	0.815
50	11033	20.00	0.848

SL. No.	Section No.	ØA	Weight kg/m
51	11015	21.00	0.935
52	11130	21.50	0.980
53	11030	22.00	1.027
54	11021	22.20	1.045
55	11117	23.00	1.122
56	11112	24.00	1.221
57	11107	24.50	1.272
58	11034	25.00	1.325
59	11016	25.40	1.368
60	11137	25.50	1.379
61	11024	25.80	1.412
62	11040	26.30	1.467
63	11036	27.00	1.546
64	11031	28.00	1.662
65	11091	28.57	1.731
66	11035	30.00	1.908
67	11150	30.40	1.960
68	11132	30.90	2.025
69	11027	31.80	2.144
70	11028	32.00	2.171
71	S1814	32.40	2.226
72	11077	33.00	2.309
73	11045	34.92	2.585
74	11103	35.60	2.688
75	11084	36.00	2.748
76	11147	37.50	2.982
77	11032	38.00	3.062
78	11017	38.10	3.078
79	11065	39.00	3.225
80	11018	40.00	3.393
81	11149	40.90	3.547
82	11048	42.00	3.741
83	11020	43.00	3.920
84	11037	44.45	4.190
85	11056	44.70	4.237
86	11086	45.00	4.294
87	11136	48.10	4.906
88	11019	50.00	5.301
89	11038	50.80	5.472
90	11049	51.75	5.679
91	11057	53.50	6.07
92	11073	55.00	6.415
93	11060	56.00	6.650
94	11090	57.15	6.926
95	11076	60.00	7.634
96	11114	62.60	8.310
97	11050	63.50	8.550
98	11110	63.60	8.577
99	11088	65.00	8.959
100	11126	65.40	9.070
101	11151	66.68	9.429
102	11102	68.30	9.892
103	11111	68.20	9.863
104	11118	69.20	10.155
105	11119	69.40	10.213
106	11087	70.00	10.390
107	11063	71.00	10.619
108	11105	72.00	10.993

SL. No.	Section No.	ØA	Weight kg/m
109	S2083	73.00	11.301
110	11094	75.00	11.928
111	11051	76.20	12.312
112	11120	79.40	13.369
113	11061	80.00	13.572
114	11115	82.55	14.450
115	11092	85.00	15.321
116	11122	88.90	16.759
117	11062	90.00	17.176
118	11123	95.25	19.239
119	11080	100.00	21.206
120	11052	101.60	21.890
121	11148	105.00	23.379
122	11093	107.95	24.711
123	11074	110.00	29.659
124	11141	114.30	27.704
125	11095	115.00	28.045
126	11039	120.00	30.536
127	11124	120.65	30.868
128	11055	125.00	33.134
129	11121	126.00	33.666
130	11127	127.00	34.203
131	11089	130.00	35.838
132	11152	133.35	37.709
133	11099	135.00	38.647
134	11075	140.00	41.563
135	11104	143.00	46.363
136	11101	146.00	45.202
137	11064	150.00	47.713
138	11125	152.40	49.252
139	11097	153.00	49.640
140	11143	155.00	50.947
141	11144	160.00	54.287
142	11078	162.00	55.652
143	11109	165.00	57.733
144	11100	170.00	61.285
145	11153	171.45	62.335
146	11134	175.00	64.942
147	11154	177.80	67.037
148	11058	180.00	68.706
149	11155	184.15	71.911
150	11098	190.00	76.552
151	11140	190.50	76.956
152	11108	200.00	84.823
153	11131	203.00	87.387
154	11159	203.20	87.559
155	11142	208.00	91.745
156	11138	211.00	94.410
157	11156	215.90	98.846
158	11160	228.60	110.817
159	11145	230.00	112.178
160	11161	241.30	123.472
161	11146	254.00	136.811
162	11157	260.35	143.737
163	11158	279.40	165.541

SQUARE BARS & HEXAGONAL BARS

SQUARE BARS

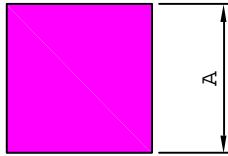

SL. No.	Section No.	A	Weight kg/m
1	11723	5.00	0.068
2	11701	6.35	0.109
3	11702	7.93	0.170
4	11709	8.00	0.173
5	11703	9.53	0.245
6	11704	10.00	0.270
7	11722	12.00	0.389
8	11705	12.70	0.435
9	11711	15.00	0.608
10	11706	15.88	0.681
11	11735	17.00	0.780
12	11707	19.05	0.980
13	11708	20.00	1.080
14	11731	22.22	1.333
15	11710	25.00	1.688
16	11719	25.50	1.756
17	11726	30.00	2.430
18	11716	31.75	2.722
19	11721	32.00	2.765
20	11732	35.00	3.308
21	11713	38.10	3.920
22	11717	40.00	4.320
23	11725	45.00	5.467
24	11714	50.00	6.750
25	11733	50.80	6.967
26	11727	60.00	9.720
27	11724	63.00	10.716
28	11712	69.85	13.173
29	11736	72.00	13.996
30	11718	76.25	15.698
31	11720	80.00	17.280
32	11734	83.00	18.600
33	11715	101.60	27.870
34	11728	110.00	32.670
35	11729	120.00	38.880
36	S2011	124.00	41.515
37	11730	130.00	45.630

HEXAGONAL BARS

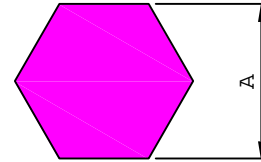

SL. No.	Section No.	A	Weight kg/m
1	11851	5.00	0.058
2	11852	7.00	0.115
3	11871	8.00	0.150
4	11853	9.00	0.189
5	11854	9.52	0.212
6	11861	10.00	0.234
7	11855	11.00	0.283
8	11872	12.00	0.337
9	11856	12.70	0.377
10	11881	13.00	0.395
11	11887	13.85	0.449
12	11857	14.00	0.458
13	11864	16.00	0.599
14	11876	16.85	0.664
15	11882	16.89	0.667
16	11858	17.00	0.675
17	S1807	17.50	0.716
18	11870	18.00	0.758
19	11874	18.85	0.831
20	11869	18.90	0.835
21	11866	19.10	0.853
22	11867	22.00	1.132
23	11878	22.10	1.142
24	S1975	22.25	1.157
25	11873	23.85	1.330
26	11862	24.00	1.347
27	11859	25.00	1.461
28	11875	26.85	1.686
29	11868	27.00	1.705
30	S1932	27.15	1.723
31	11865	29.00	1.966
32	S2009	30.19	2.131
33	11884	30.50	2.175
34	11860	32.00	2.394
35	11879	36.00	3.03
36	11886	37.50	3.288
37	11885	38.10	3.394
38	11880	41.00	3.930
39	11883	41.27	3.984
40	11863	50.00	5.846

MISCELLANEOUS BARS

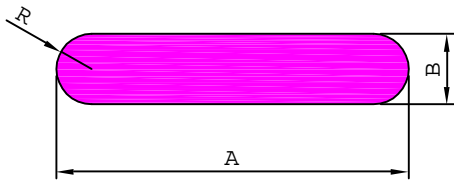

SL. No.	Section No.	A	B	R	Weight kg/m
1	12099	9.50	2.50	1.25	0.060
2	12143	20.00	5.00	2.50	0.256
3	12094	25.00	3.00	1.75	0.196
4	12030	25.20	6.30	3.15	0.405
5	12039	40.00	10.00	5.00	1.022
6	12117	50.00	6.00	3.00	0.789
7	12001	50.00	10.00	5.00	1.292
8	12111	50.00	12.00	6.00	1.537
9	12046	50.40	6.30	3.15	0.834
10	12075	60.00	6.20	3.10	0.982
11	12041	63.50	6.35	3.18	1.065
12	12116	75.00	6.00	3.00	1.194
13	12150	76.20	9.52	4.76	1.906
14	12100	100.00	6.00	3.00	1.599
15	12144	100.00	12.00	6.00	3.157
16	12050	101.60	6.35	3.175	1.720
17	12102	150.00	6.00	3.00	2.409
18	12042	152.40	6.35	3.175	2.590
19	12068	200.00	12.00	6.00	6.397
20	12125	200.00	8.00	4.00	4.283

12002 0.403 kg/m

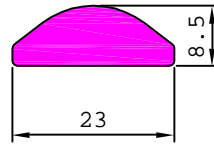

12003 0.314 kg/m

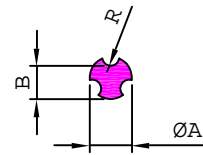
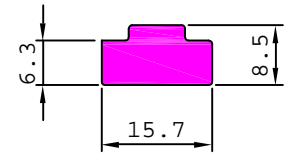

SL. No.	Section No.	A	B	R	Weight kg/m
1	12049	5.60	4.55	1.25	0.052
2	12024	5.80	4.30	1.50	0.045
3	12004	6.00	4.75	1.25	0.057
4	12021	6.00	4.50	1.20	0.053
5	12038	6.30	4.70	1.19	0.059

12006 0.483 kg/m

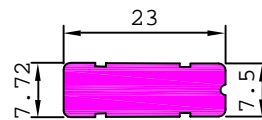

12007 0.584 kg/m

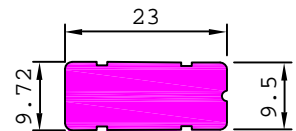

12008 0.801 kg/m

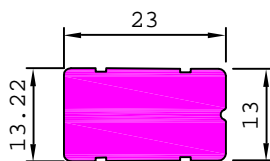

12009 0.399 kg/m

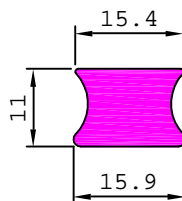

12011 0.040 kg/m

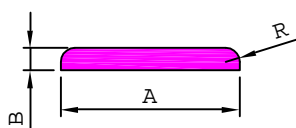
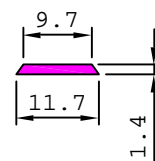

SL. No.	Section No.	A	B	R	Weight kg/m
1	12010	25.40	3.18	1.98	0.213
2	12089	25.00	2.95	2.00	0.194

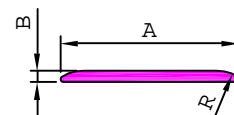

SL. No.	Section No.	A	B	R	Weight kg/m
1	12016	25.40	1.60	6.00	0.104
2	12017	25.40	1.88	6.00	0.120
3	12095	24.75	1.17	1.00	0.077

MISCELLANEOUS BARS

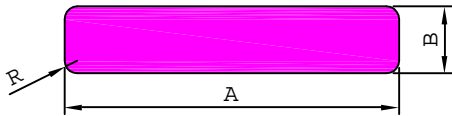

SL. No.	Section No.	A	B	R	Weight kg/m
1	S1989	6.80	2.00	0.60	0.036
2	S1990	8.50	2.00	0.60	0.045
3	S2066	30.00	16.00	1.00	1.294
4	12134	40.00	10.00	3.00	1.059
5	12147	40.00	26.00	3.00	2.787
6	12086	50.00	8.00	3.00	1.059
7	12135	50.00	10.00	3.00	1.329
8	12096	50.00	12.00	3.00	1.599
9	12128	60.00	10.00	1.00	1.618
10	12136	60.00	10.00	3.00	1.559
11	12092	65.00	8.00	3.00	1.383
12	12023	80.00	10.00	3.00	2.138
13	12072	80.00	22.00	1.00	4.749
14	12131	90.00	75.00	0.50	18.225
15	12137	100.00	10.00	3.00	2.679
16	12114	100.00	12.00	3.00	3.219
17	S1753	100.00	35.00	1.00	9.448
18	12069	101.60	9.52	1.50	2.606
19	S1812	116.00	88.00	1.00	27.559
20	12141	120.00	10.00	3.00	3.219
21	12113	120.00	12.00	3.00	3.867
22	12115	120.00	16.00	3.00	5.163
23	12105	120.00	45.00	1.00	14.578
24	12080	120.00	100.00	2.00	32.391
25	12062	126.00	15.00	1.00	5.100
26	12124	130.00	17.00	1.00	5.965
27	12091	130.00	100.00	1.00	35.098
28	12138	140.00	10.00	3.00	3.759
29	S1779	140.00	35.00	1.00	13.228
30	12145	140.00	110.00	1.00	41.578
31	12133	145.00	4.80	1.00	1.877
32	S1810	148.00	93.00	1.00	37.160
33	12104	151.00	111.00	2.00	45.245
34	12127	152.00	80.00	1.00	32.830
35	12061	155.00	28.00	1.00	11.715
36	12130	155.00	58.00	1.00	24.271
37	12098	160.00	10.00	3.00	4.299
38	S1808	160.00	85.00	1.00	36.718
39	12126	160.00	90.00	1.00	38.878
40	S1923	161.00	40.00	1.00	17.386
41	S1811	163.00	39.00	1.00	17.162
42	12055	165.00	85.00	2.00	37.858
43	12140	168.00	133.00	1.00	60.326
44	12132	169.00	4.80	1.00	2.188
45	12112	169.00	47.00	1.00	21.444
46	S1809	170.00	77.00	1.00	35.341
47	12109	180.00	10.00	3.00	4.839
48	12071	185.00	15.00	1.00	7.490

SL. No.	Section No.	A	B	R	Weight kg/m
49	12139	200.00	10.00	3.00	5.379
50	12065	200.00	20.00	1.00	10.800
51	12118	200.00	32.00	1.00	17.278
52	12087	203.20	9.52	3.00	5.202
53	12070	205.00	15.00	1.00	8.300
54	12083	212.00	38.00	2.00	21.742
55	12123	212.00	48.00	1.00	27.473
56	12073	215.00	23.00	1.50	13.346
57	12078	222.00	32.00	1.50	19.176
58	12103	223.00	18.00	1.00	10.835
59	12108	225.00	14.50	2.00	8.799
60	12129	225.00	17.50	3.00	10.610
61	12074	233.00	17.00	1.00	10.692
62	S1659	241.25	25.00	2.00	16.258
63	12084	250.00	18.00	1.50	12.145
64	12054	250.00	30.00	2.50	20.236
65	S1798	254.00	21.50	1.00	14.742
66	12097	255.00	17.50	1.50	12.044
67	12063	255.00	23.00	1.00	15.833
69	12090	256.00	4.82	2.00	3.322
70	12088	256.00	9.52	2.00	6.571
71	12081	260.00	23.00	2.00	16.137
72	12101	260.00	28.00	2.00	19.647
73	12110	265.00	18.00	2.00	12.879
74	12064	276.00	23.00	2.00	17.130
75	12082	284.00	18.00	2.00	13.793
76	12085	285.00	23.00	2.00	17.699

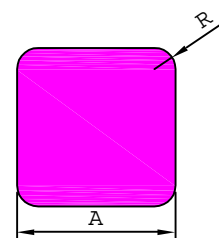

SL. No.	Section No.	A	R	Weight kg/m
1	12148	15.70	5.00	0.608
2	12142	90.00	3.00	21.849
3	12019	140.00	3.00	52.898

12022 0.510 kg/m

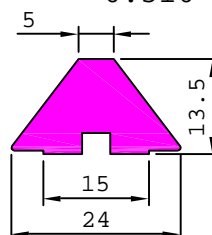

12026 0.197 kg/m

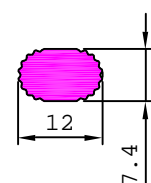

MISCELLANEOUS BARS

12032

1.381 kg/m

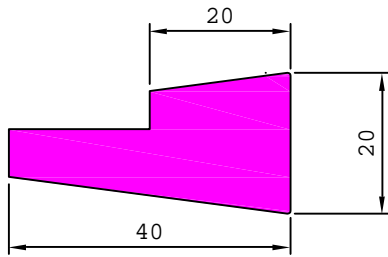

12037

0.201 kg/m

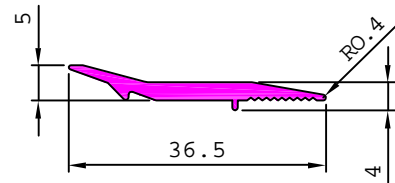

12047

2.009 kg/m

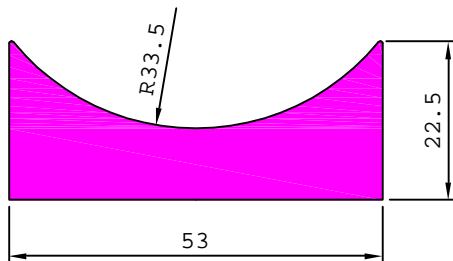

12045

12.102 kg/m

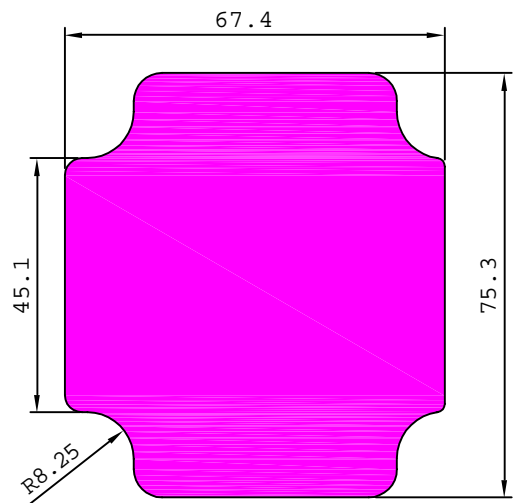

12048

2.060 kg/m

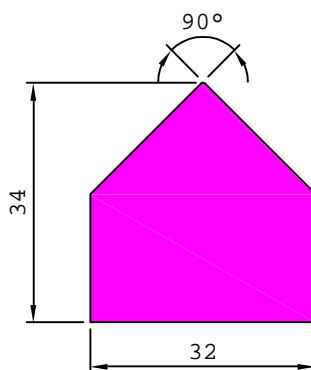

12076

3.235 kg/m

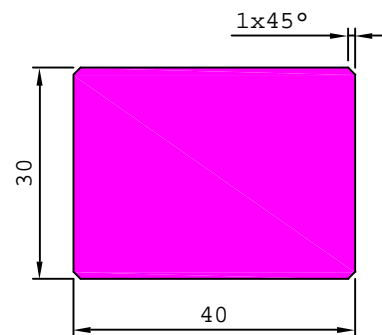

12067

0.571 kg/m

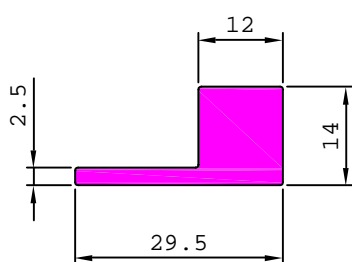

12077

1.151 kg/m

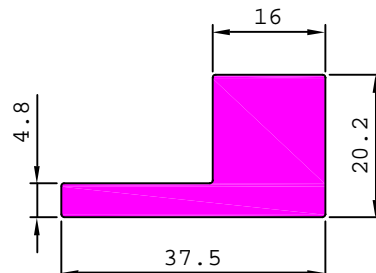

12079

0.563 kg/m

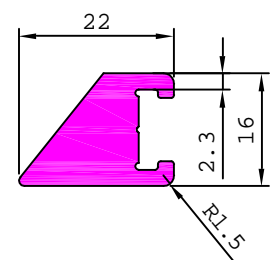

BARS & RODS

MISCELLANEOUS BARS

12093

0.381 kg/m

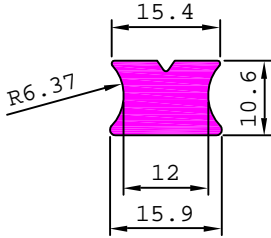

12106

0.424 kg/m

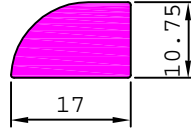

12107

0.495 kg/m

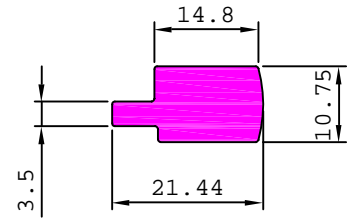

12119

2.598 kg/m

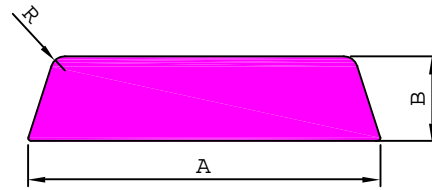
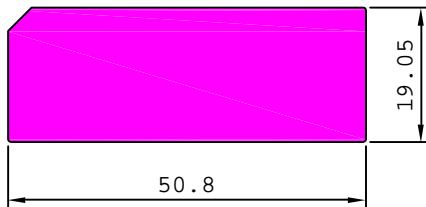

SL. No.	Section No.	A	B	R1	Weight kg/m
1	12120	50.00	12.00	2.00	1.501
2	12121	50.00	12.00	8.00	1.469
3	12122	40.00	8.00	2.00	0.812

12149 1.120 kg/m

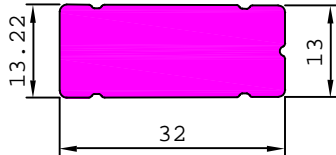

12151 0.267 kg/m

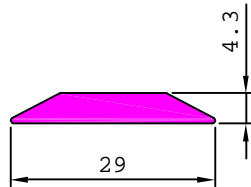

12152 0.811 kg/m

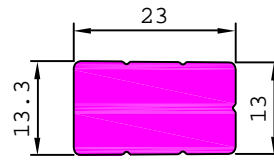

S1745 0.631 kg/m

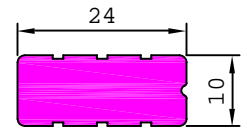

S2030

2.191 kg/m

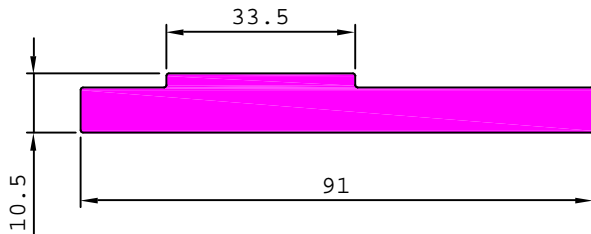

S2031

2.505 kg/m

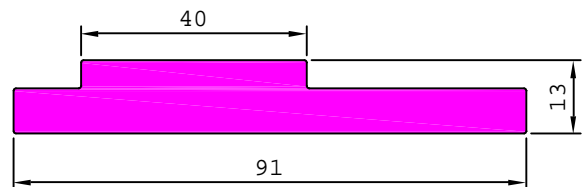

12153

6.610 kg/m

