

## BUS WINDOW GUIDE FRAMES

24202 0.310 kg/m

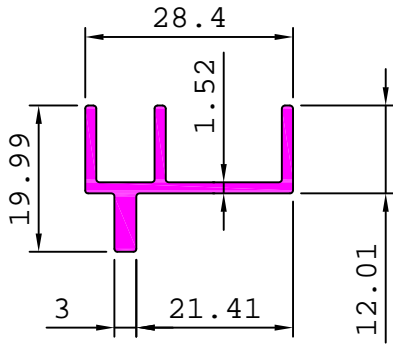

24204 0.247 kg/m

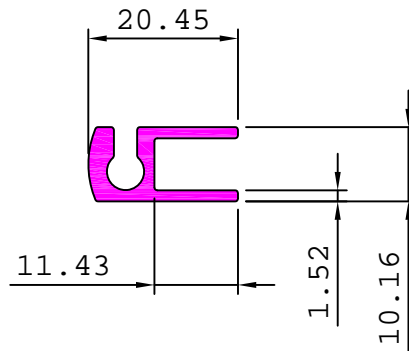

24205 0.279 kg/m

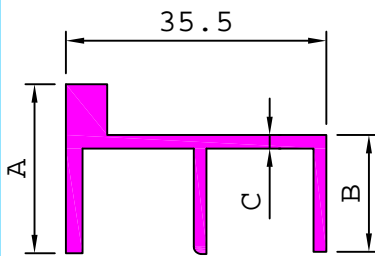
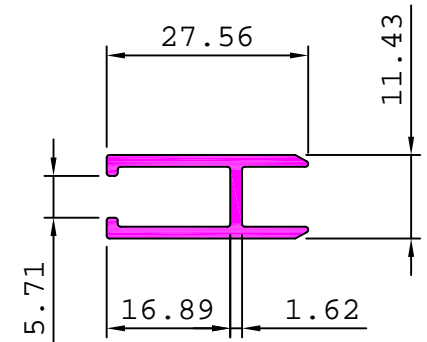

| SL. No. | Section No. | A     | B     | C    | Weight kg/m |
|---------|-------------|-------|-------|------|-------------|
| 1       | 24218       | 22.60 | 15.70 | 1.85 | 0.464       |
| 2       | 24206       | 23.00 | 16.00 | 1.13 | 0.333       |

24211 0.148 kg/m

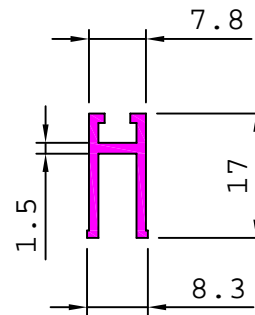

24212 0.171 kg/m

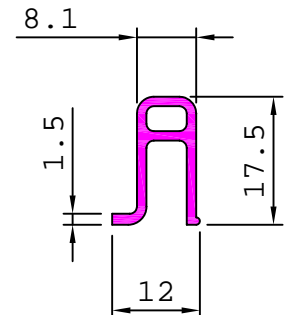

| SL. No. | Section No. | A     | B     | C    | Weight kg/m |
|---------|-------------|-------|-------|------|-------------|
| 1       | 24234       | 35.80 | 31.00 | 1.80 | 0.600       |
| 2       | 24215       | 36.20 | 30.60 | 0.97 | 0.328       |

24208 0.592 kg/m

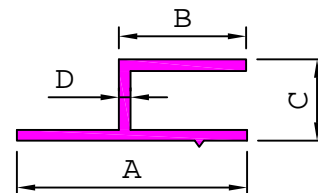
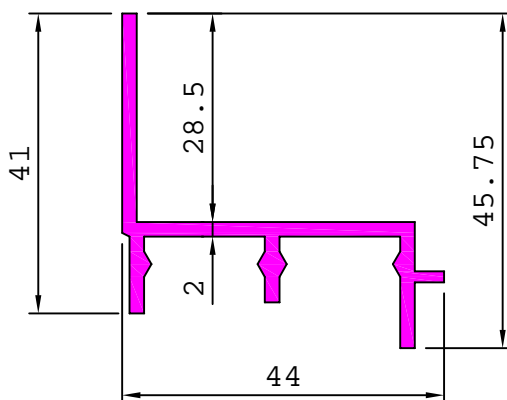

| SL. No. | Section No. | A     | B     | C     | D    | Weight kg/m |
|---------|-------------|-------|-------|-------|------|-------------|
| 1       | 24235       | 29.90 | 18.00 | 12.30 | 0.70 | 0.112       |
| 2       | 24213       | 31.00 | 16.50 | 11.00 | 0.84 | 0.130       |
| 3       | 24214       | 34.60 | 19.50 | 12.70 | 0.93 | 0.166       |

## BUS WINDOW GUIDE FRAMES

24219 0.243 kg/m

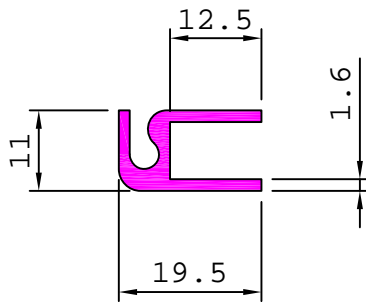

24220 0.687 kg/m

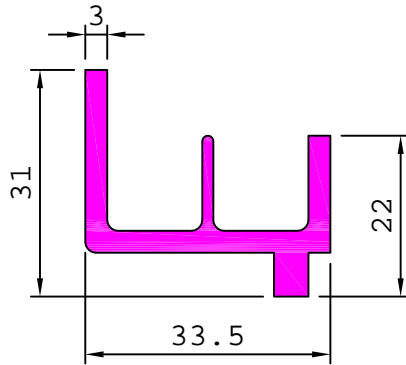

24221 0.662 kg/m

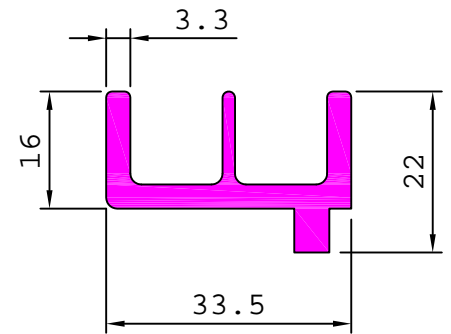

24223 0.478 kg/m

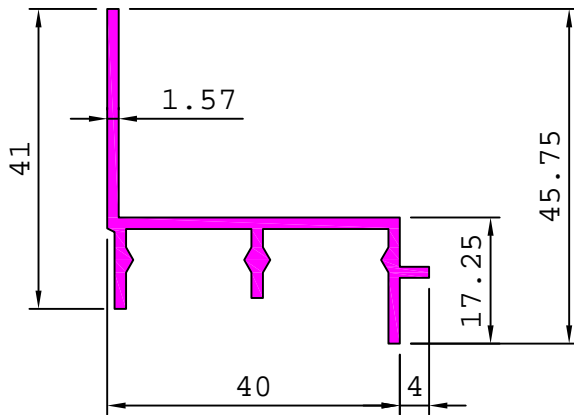

24226 0.686 kg/m

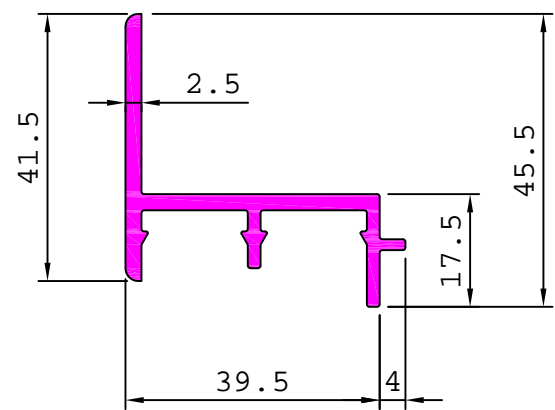

24227 0.669 kg/m

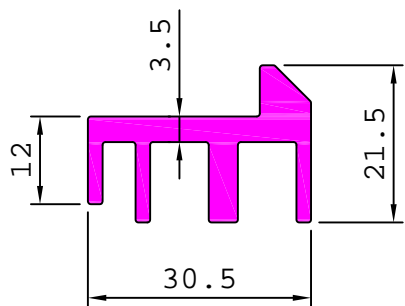

24228 0.680 kg/m

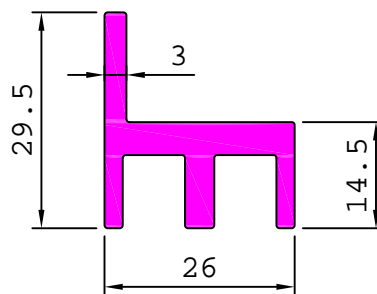

24229 0.197 kg/m

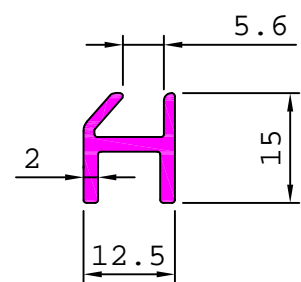

24231 0.593 kg/m

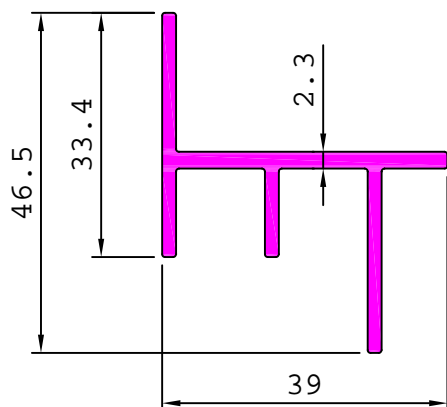

24232 0.665 kg/m

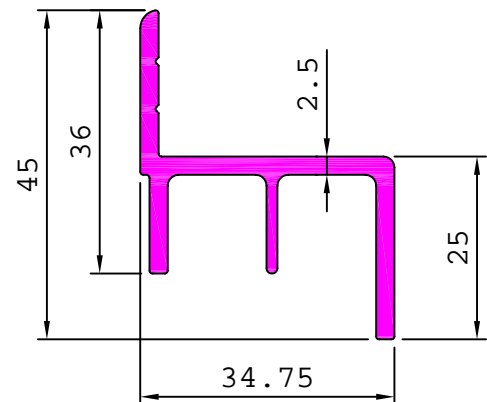

## BUS WINDOW GUIDE FRAMES

24233 0.580 kg/m

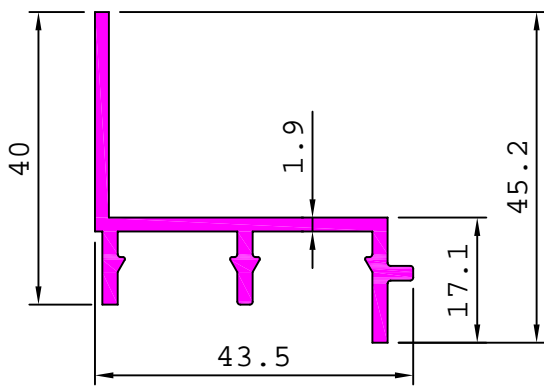

24237 0.414 kg/m

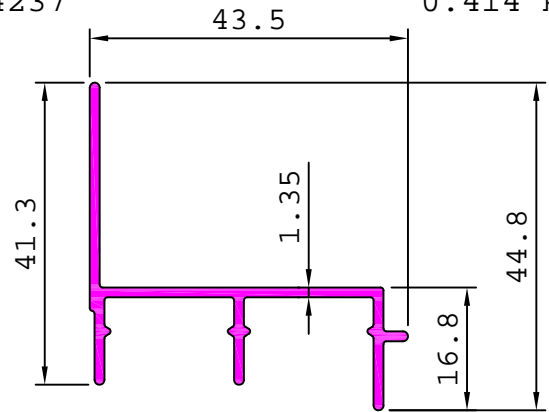

24236 0.092 kg/m

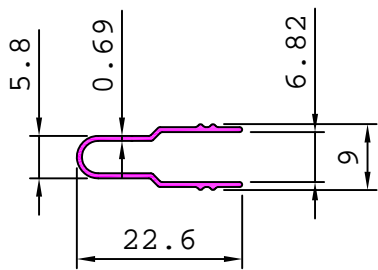

24238 0.172 kg/m

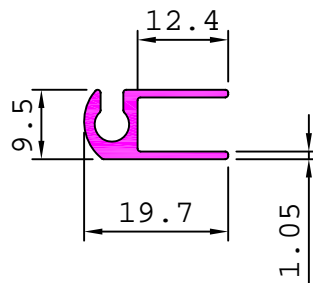

24240 0.601 kg/m

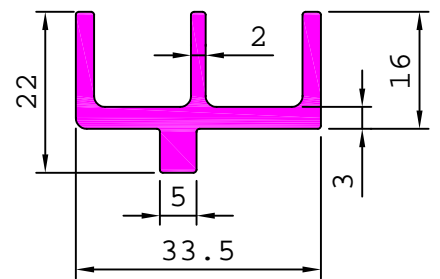

24241 0.662 kg/m

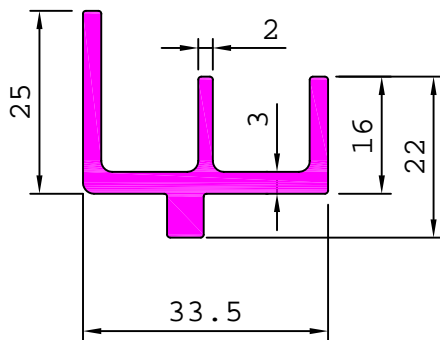

S3862 0.895 kg/m

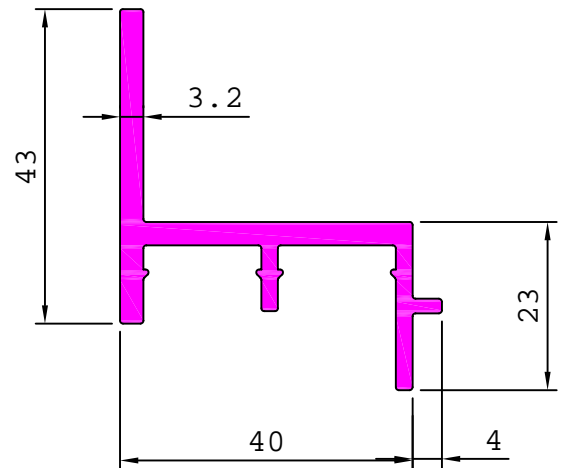

## BUS WIND SHIELDS

24304

0.439 kg/m

