

## LOUVER SECTION

20552

0.599 kg/m

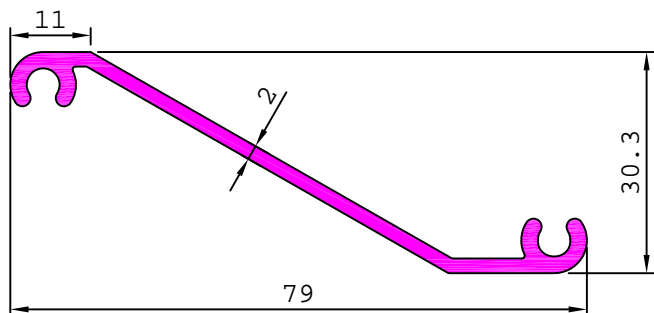

20778

0.483 kg/m

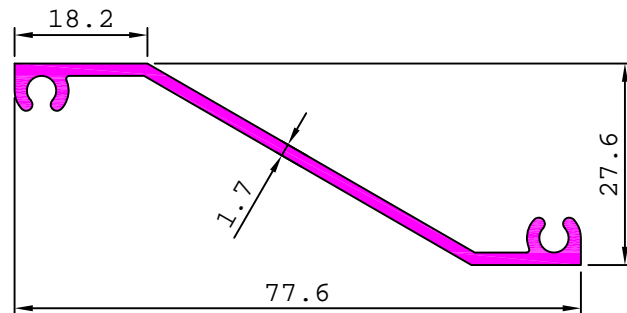

20782

0.429 kg/m

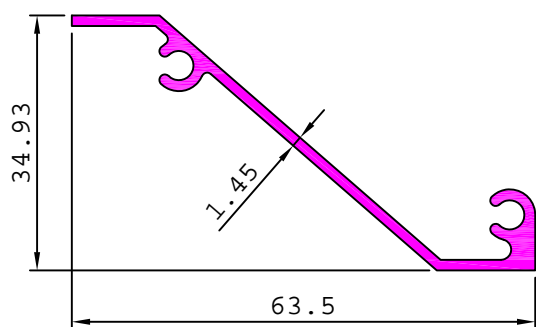

20853

0.391 kg/m

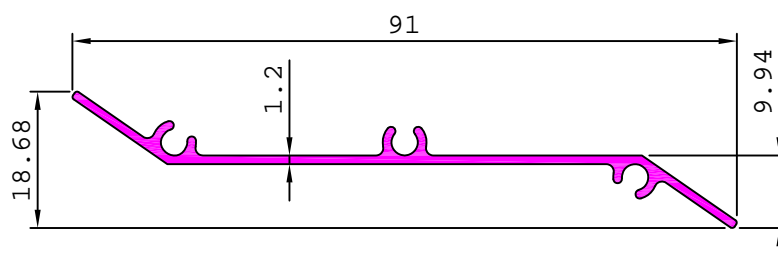

20860

0.249 kg/m

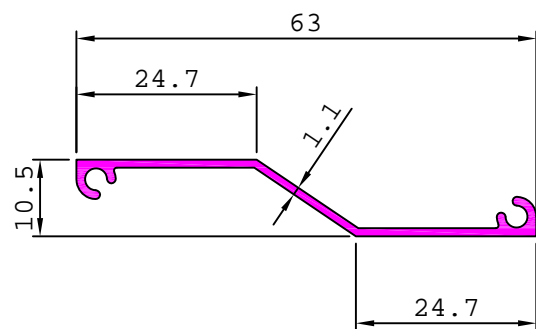

20967

0.369 kg/m

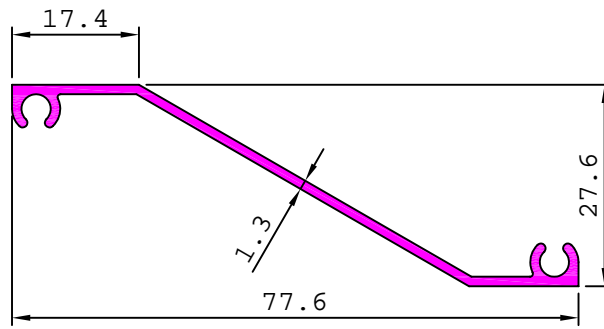

20970

0.248 kg/m

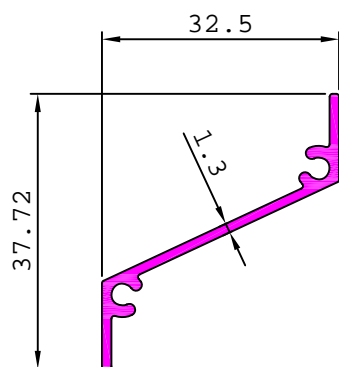

21150

0.519 kg/m

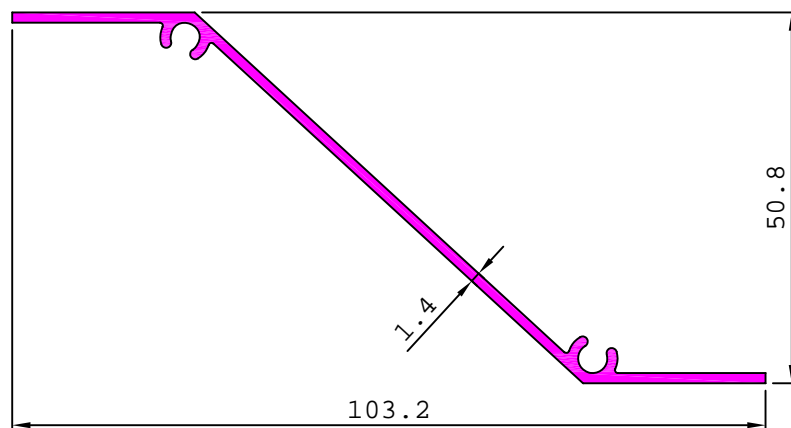

## LOUVER SECTION

21240

3.228 kg/m

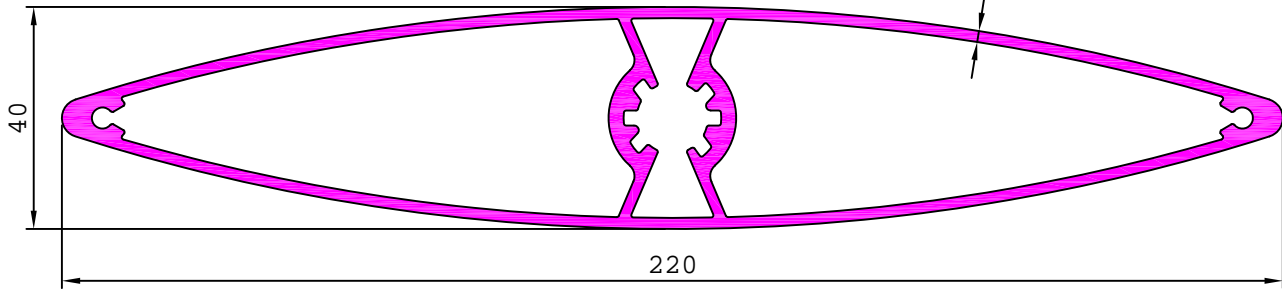

21294

0.163 kg/m

21305

0.402 kg/m

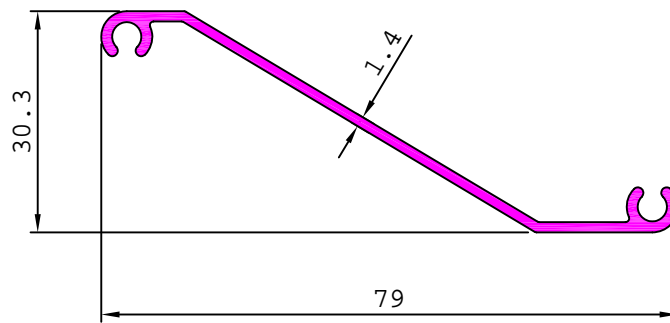
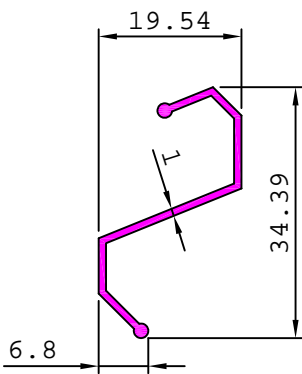

21318

0.514 kg/m

21238

0.506 kg/m

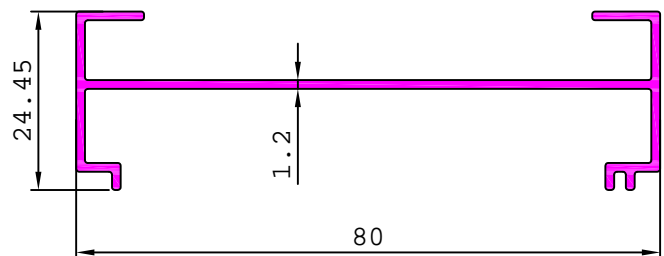
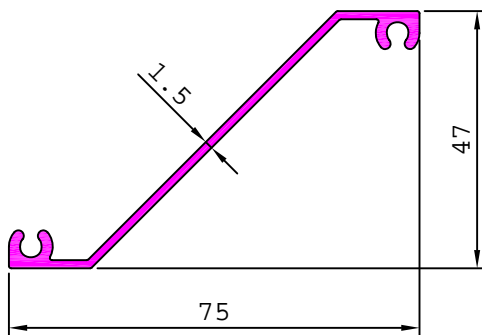

21316

1.518 kg/m

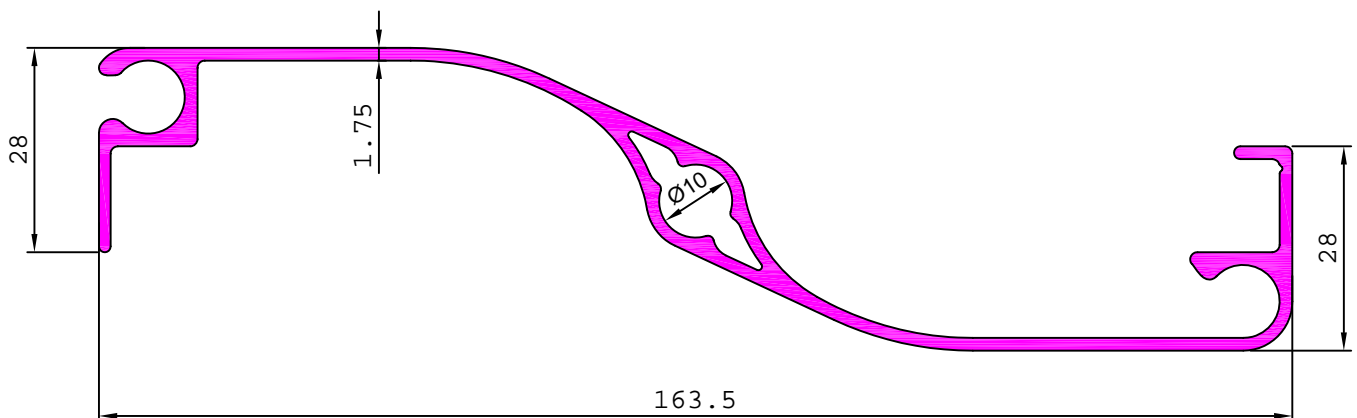

## LOUVER SECTION

28802

0.706 kg/m

29129

1.091 kg/m

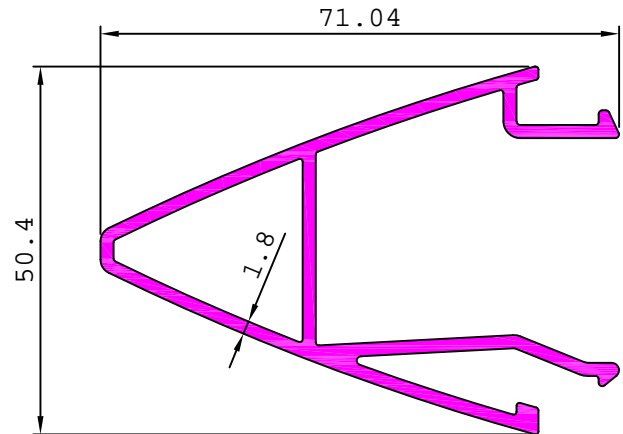
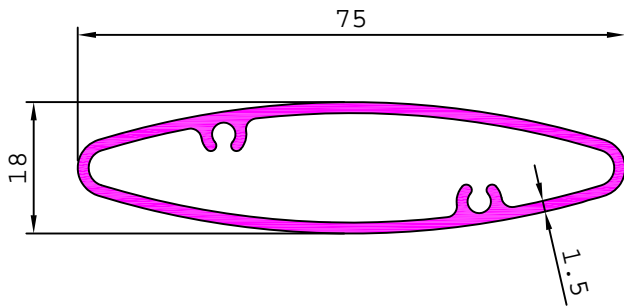

28803

1.573 kg/m

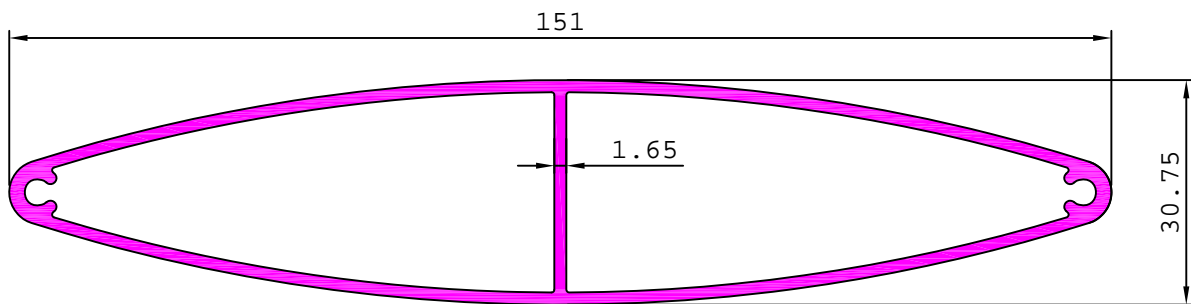

29130

3.048 kg/m

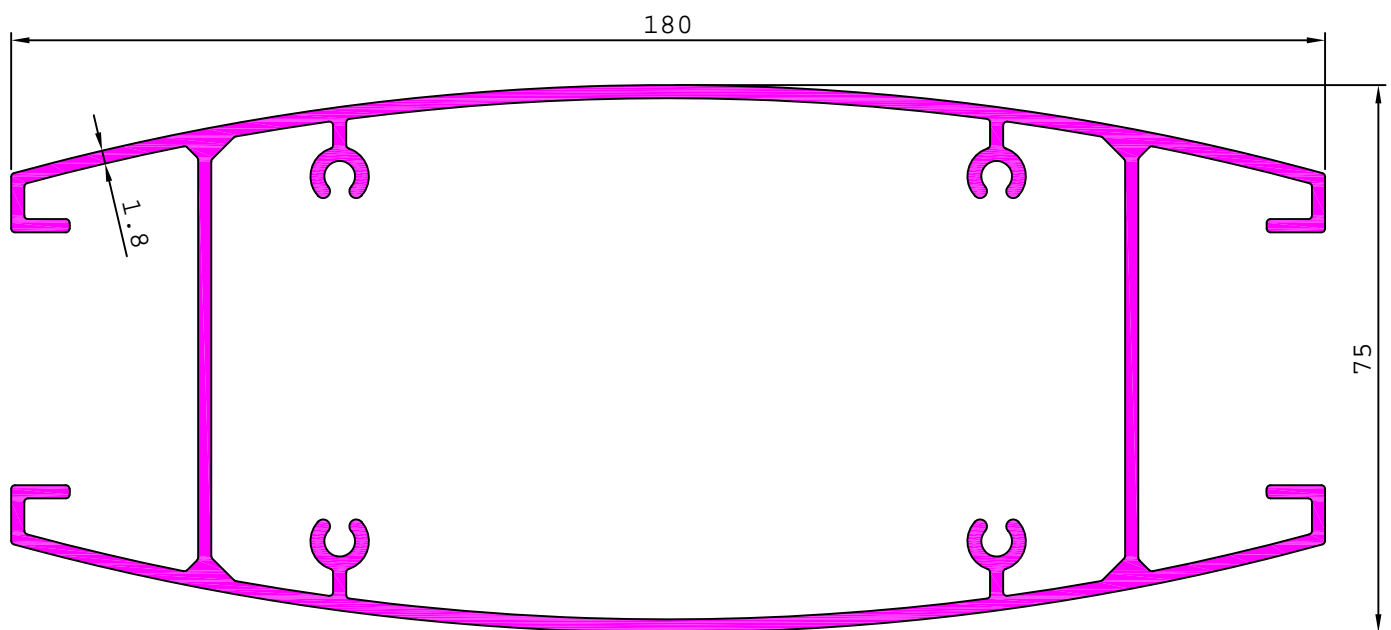

## LOUVER SECTION

29164

2.511 kg/m

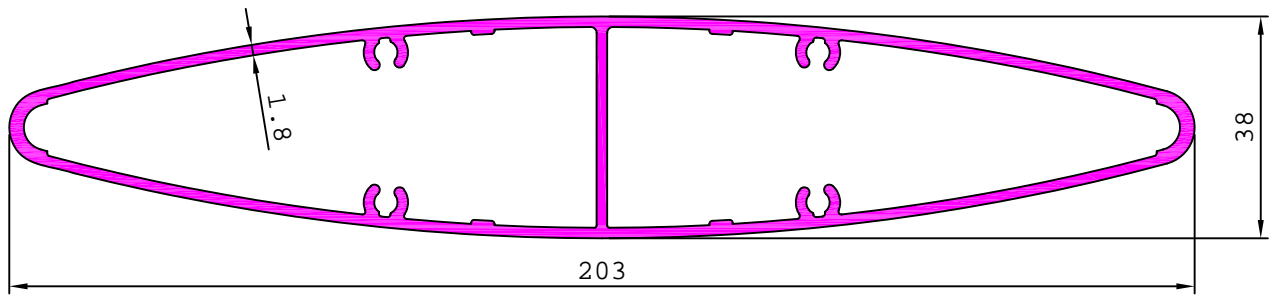

29180

3.646 kg/m

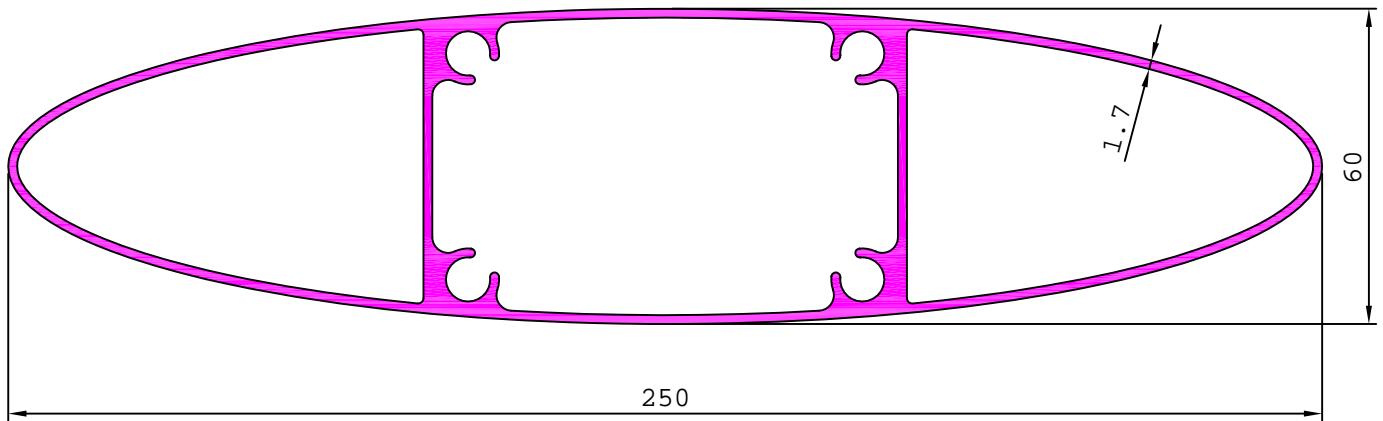

29246

4.190 kg/m

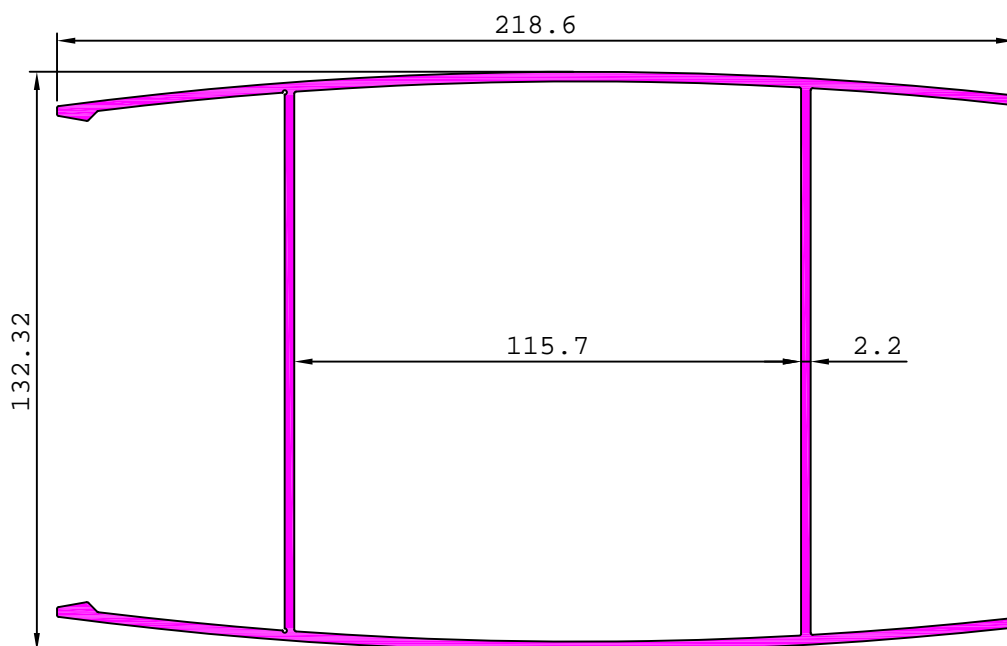

LOUVER SECTION

29243

7.723 kg/m

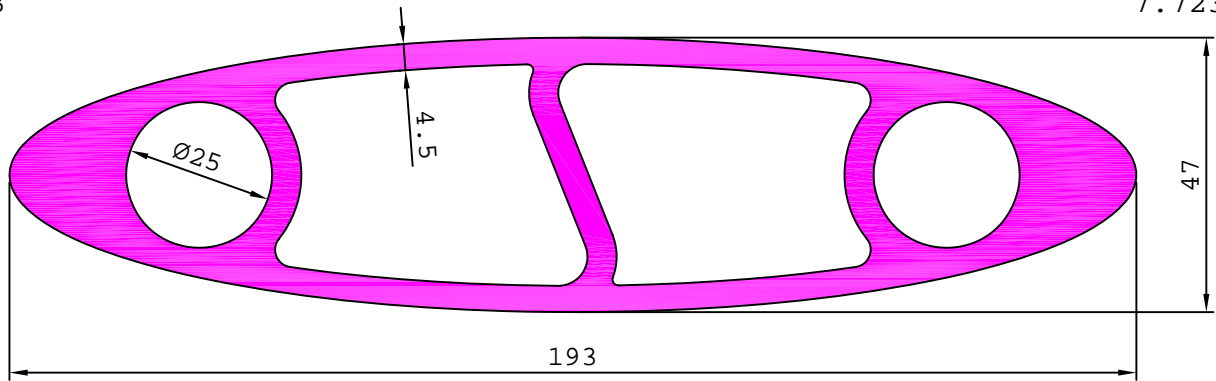

29247

3.230 kg/m

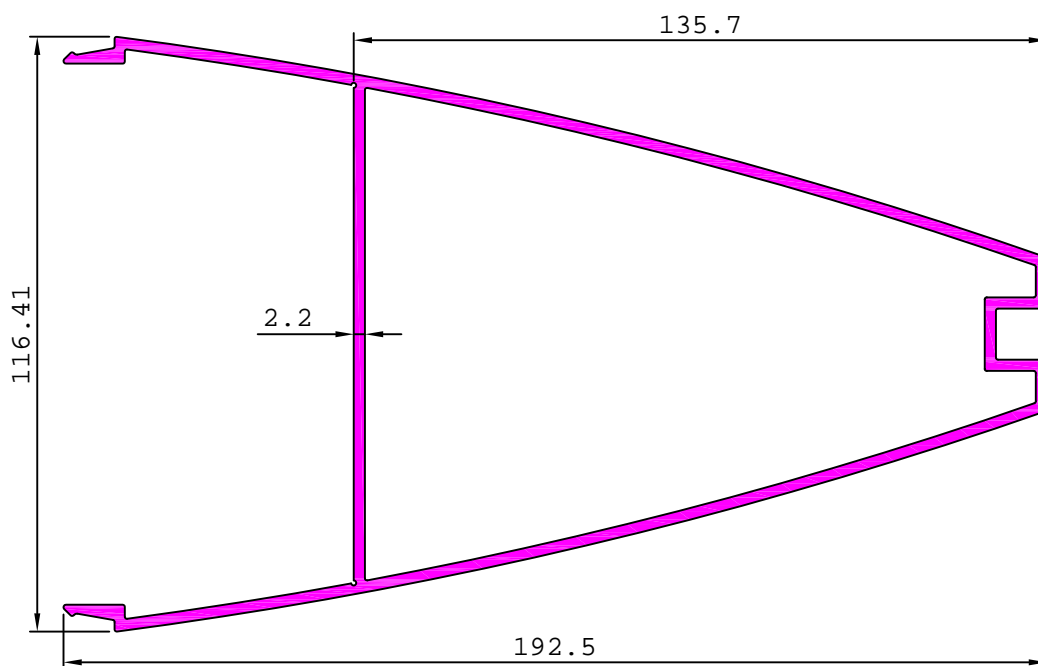

29328

2.477 kg/m

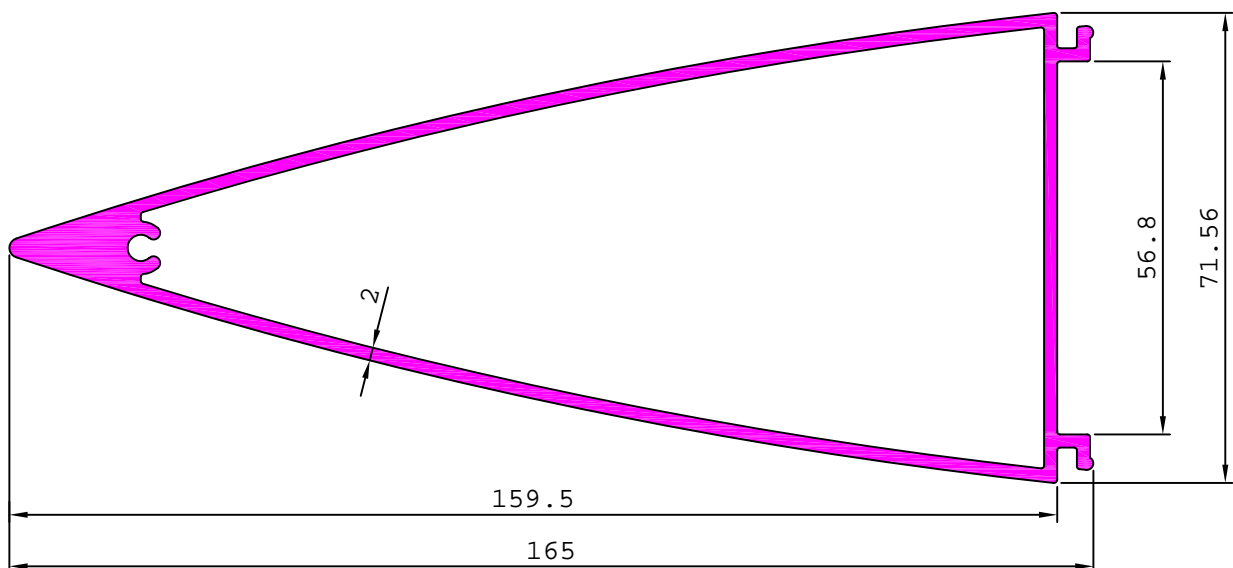

## LOUVER SECTION

29330

3.243 kg/m

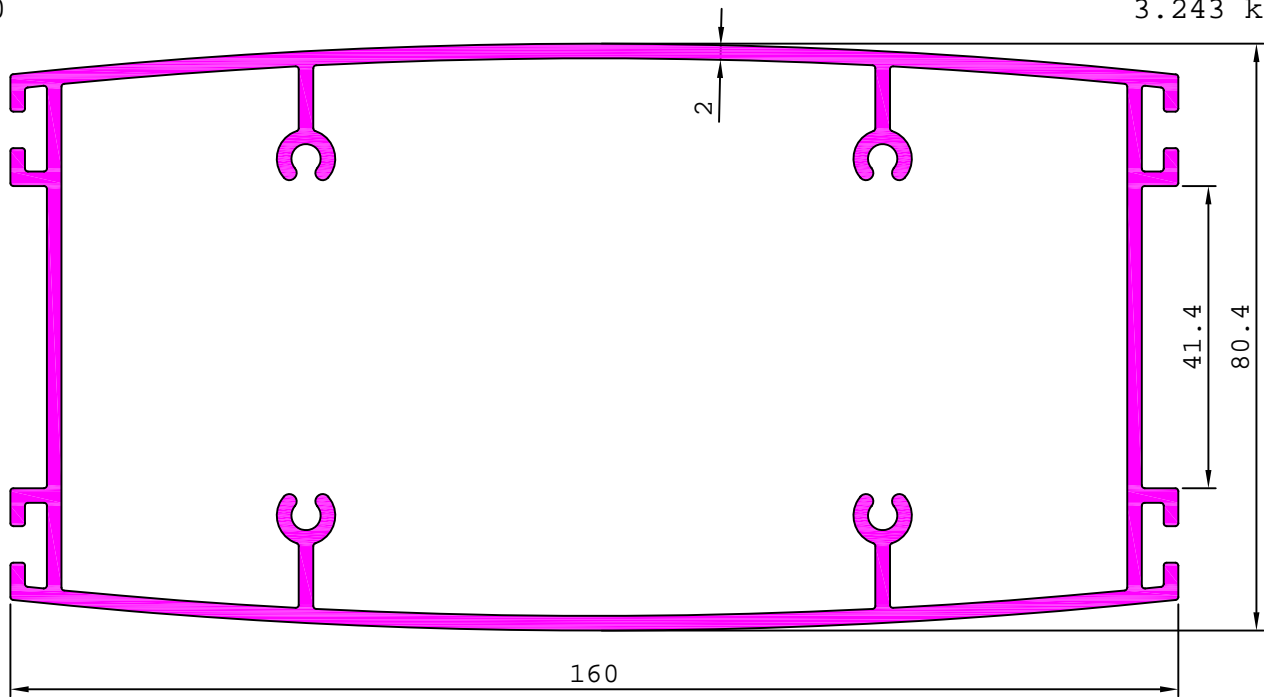

29382

6.174 kg/m

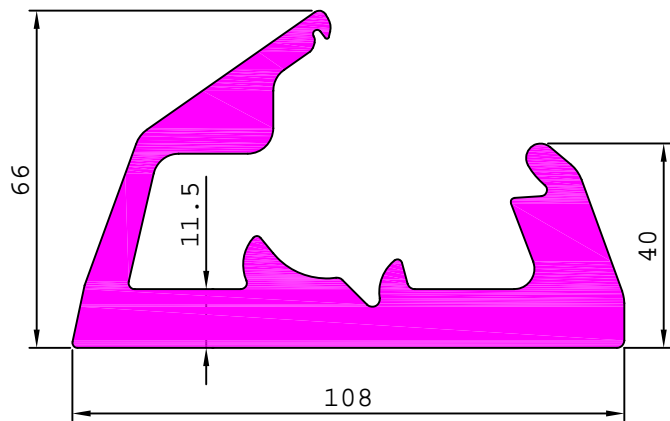

29383

3.032 kg/m

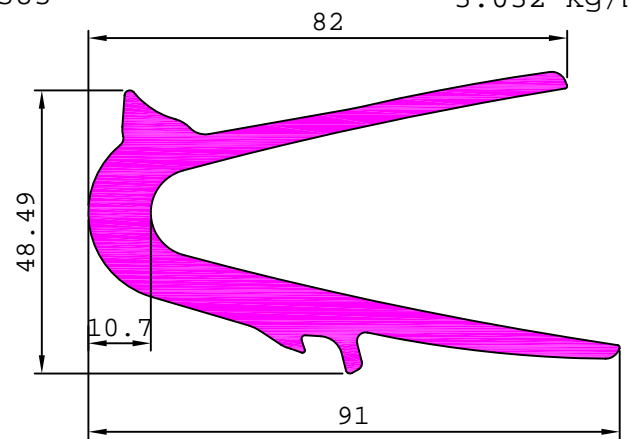

29370

6.401 kg/m

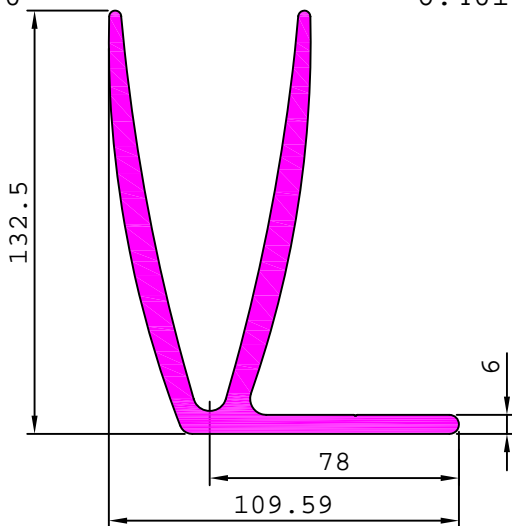

S2204

0.288 kg/m

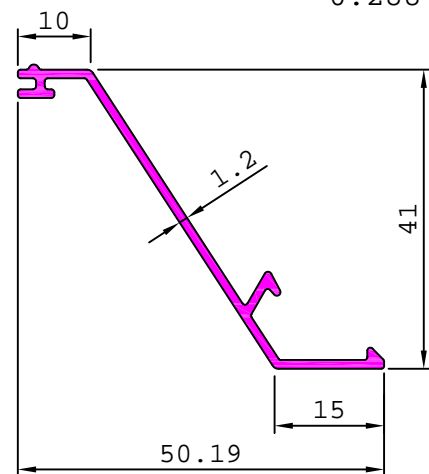

## LOUVER SECTION

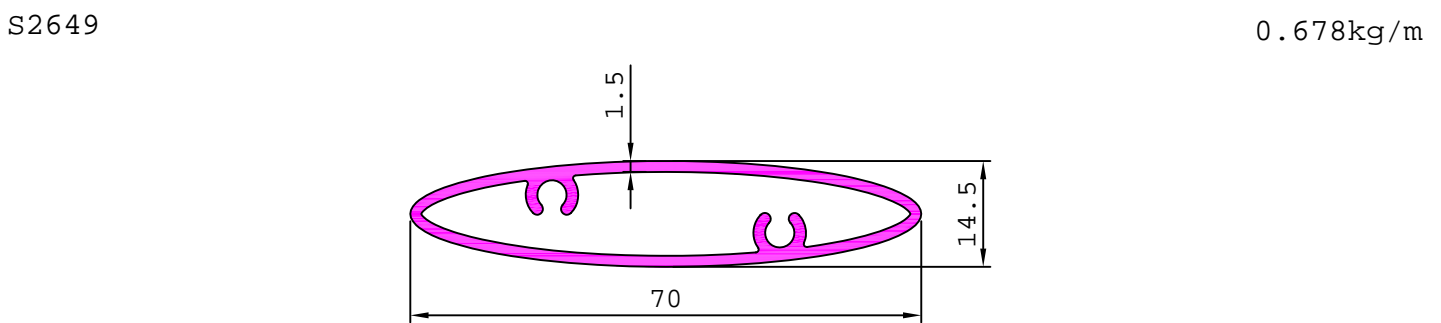
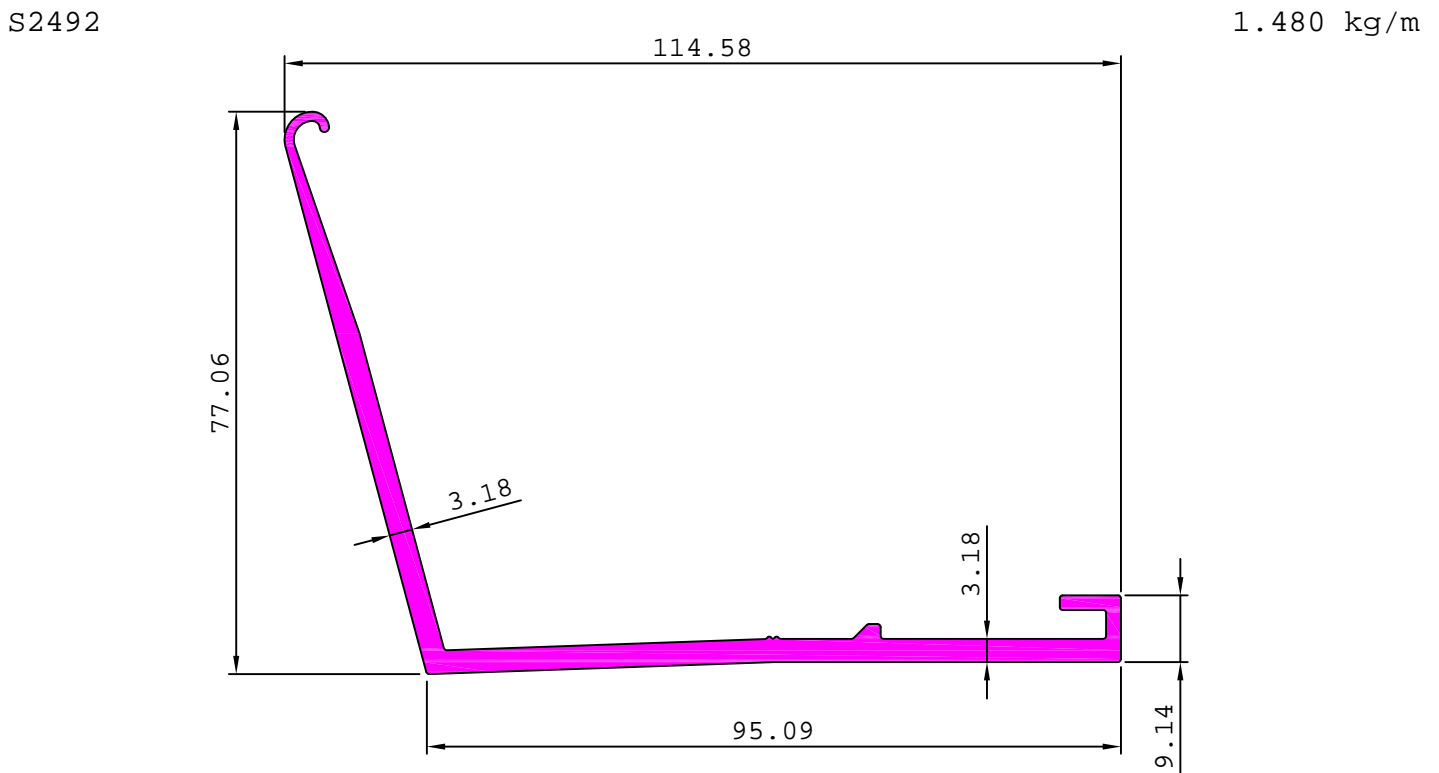
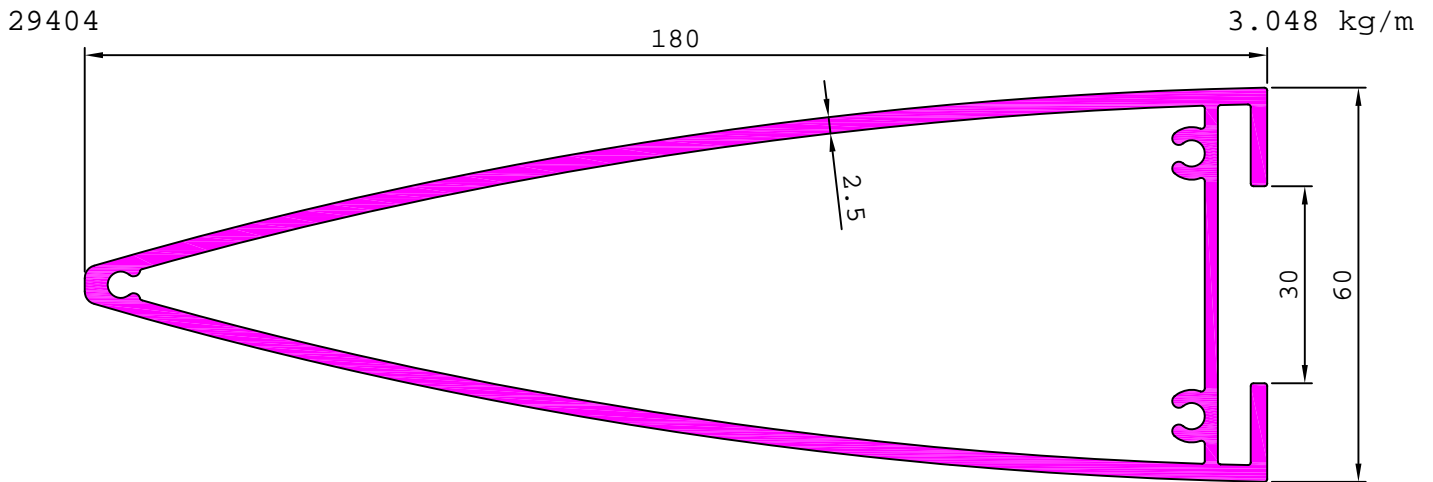

# LOUVER SECTION

S2493

1.058 kg/m

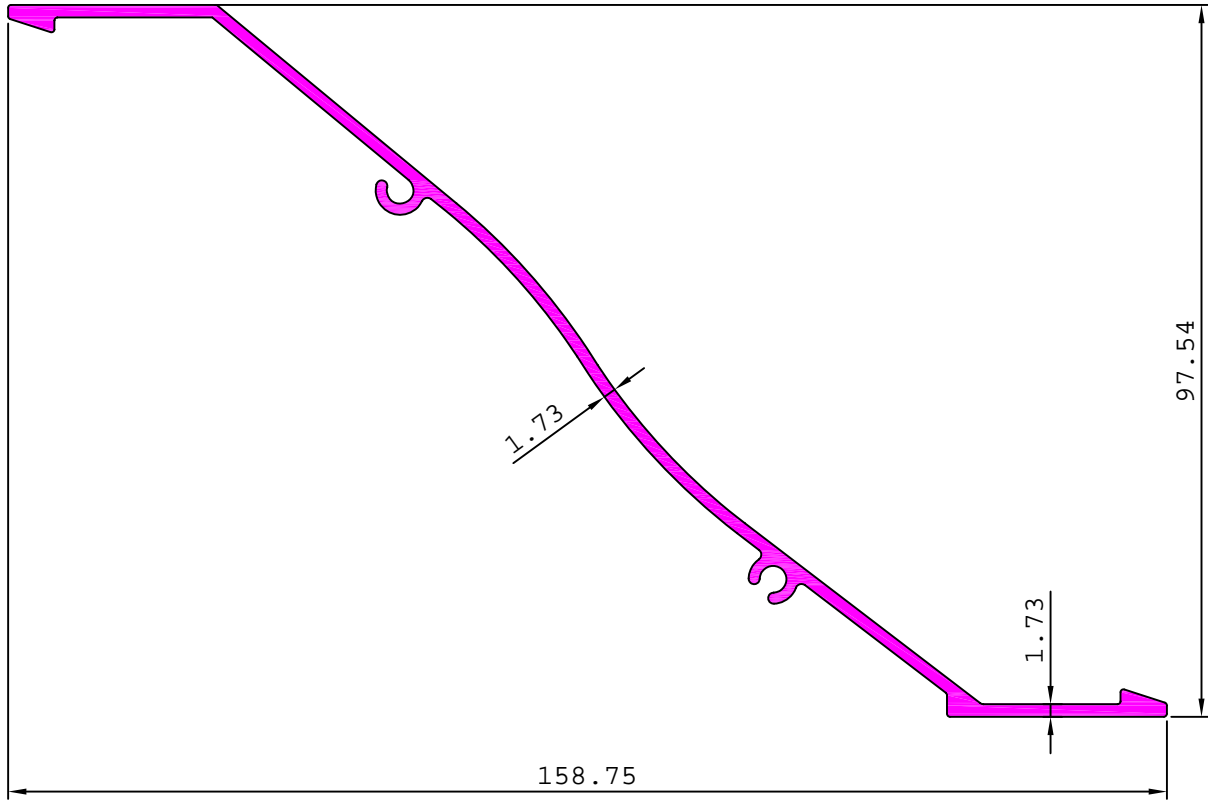

S2718

3.680 kg/m

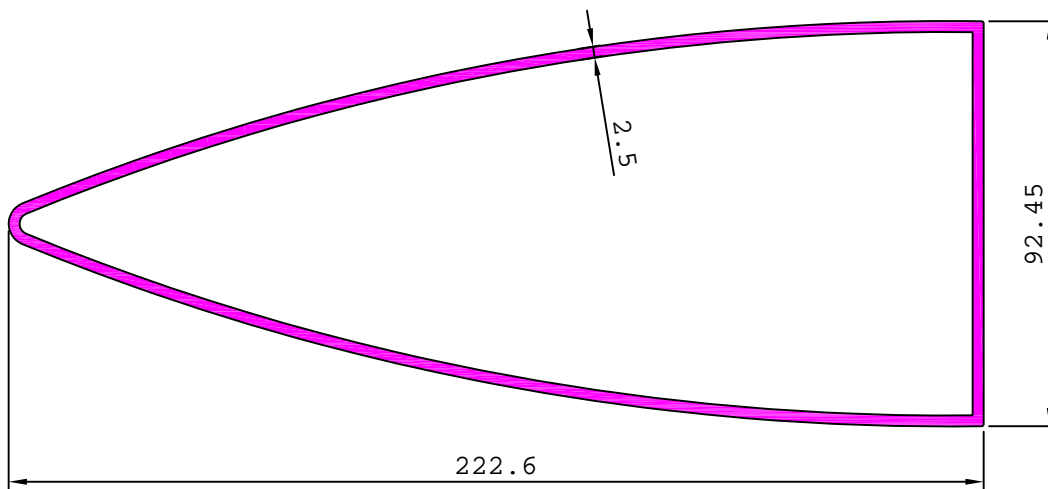



## LOUVER SECTION

S2752

0.543 kg/m

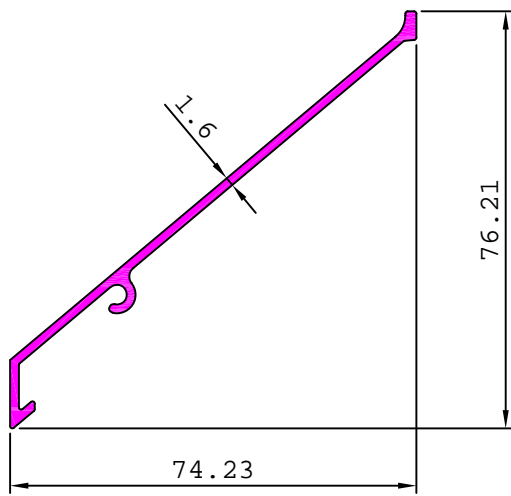

S2753

0.728 kg/m

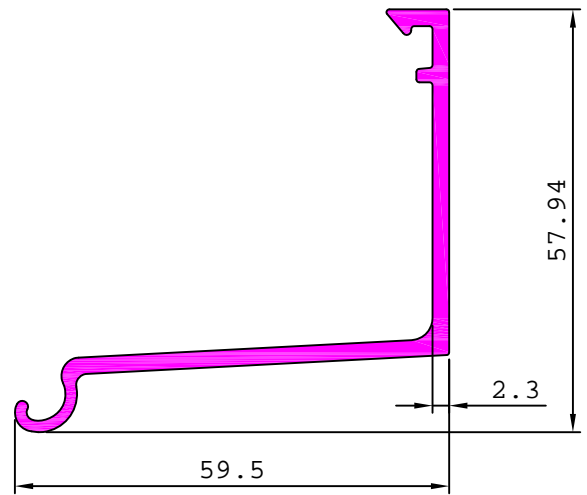

S2800

0.947kg/m

